



Mitsubishi Programmable Controller

MELSEC **Q** series

MODBUS[®]/TCP Interface Module User's Manual

-QJ71MT91
-GX Configurator-MB (SW1D5C-QMBU-E)

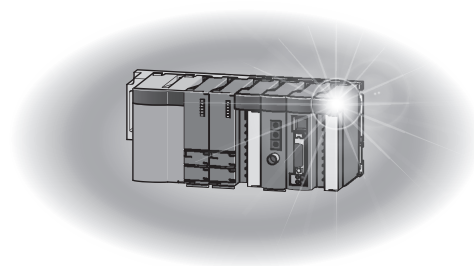

• SAFETY PRECAUTIONS •

(Always read these instructions before using this equipment.)

Before using this product, please read this manual and the relevant manuals introduced in this manual carefully and pay full attention to safety to handle the product correctly.

The instructions given in this manual are concerned with this product. For the safety instructions of the programmable controller system, please read the user's manual of the CPU module to use.

In this manual, the safety precautions are classified into two levels: "⚠ WARNING" and "⚠ CAUTION".



Indicates that incorrect handling may cause hazardous conditions, resulting in death or severe injury.



Indicates that incorrect handling may cause hazardous conditions, resulting in minor or moderate injury or property damage.

Under some circumstances, failure to observe the precautions given under "⚠ CAUTION" may lead to serious consequences.

Observe the precautions of both levels because they are important for personal and system safety. Make sure that the end users read this manual and then keep the manual in a safe place for future reference.

[Design Precautions]

⚠ WARNING

- When controlling a running programmable controller (modifying data) by connecting peripheral devices to the CPU module or connecting a personal computer to the intelligent function module, configure an interlocking circuit in a sequence program so that the safety of the overall system is always maintained. Also, before performing other control operations (program modifications and operation status modifications (status control)) on the running programmable controller, be sure to read the manual carefully and thoroughly confirm the safety. Especially in the above mentioned control operations that are performed from an external device to a remote programmable controller, any problems on the programmable controller side may not be dealt with promptly due to a data communication error. In addition to configuring an interlocking circuit in a sequence program, determine how the system handles data communication errors, etc. between the devices and the programmable controller CPU.
- Do not write any data in the "system area (Use prohibited)" of the buffer memory of the intelligent function module. Also, do not output (turn on) the "use prohibited" signal, which is one of the output signals from the programmable controller CPU to the intelligent function module. If data is written to the "system area (Use prohibited)" or the "use prohibited" signal is output, there is a risk that the programmable controller system may malfunction.

CAUTION

- Do not bundle the control wires and the communication cables with the main circuit and the power wires, and do not install them close to each other. They should be installed at least 100 mm (3.94 in.) away from each other. Failure to do so may generate noise that may cause malfunctions.

[Installation Precautions]

CAUTION

- Be sure to shut off all phases of the external power supply used by the system before mounting or removing the module.
Failure to do so may damage the module.
- Use the programmable controller in the operating environment that meets the general specifications described in the user's manual of the CPU Module to use. Using the programmable controller in any other operating environments may cause electric shocks, fires or malfunctions, or may damage or degrade the module.
- While pressing the installation lever located at the bottom of the module, insert the module fixing projection into the fixing hole in the base unit to mount the module.
Incorrect module mounting may cause a malfunction, failure, or drop of the module.
In an environment of frequent vibrations, secure the module with the screw.
- Be sure to tighten the screws using the specified torque. If the screws are loose, it may cause the module to short-circuit, malfunction or fall off. If the screws are tightened excessively, it may damage the screws and cause the module to short-circuit, malfunction or fall off.
- Do not directly touch any conductive part or electronic component of the module.
Doing so may cause a malfunction or failure of the module.

[Wiring Precautions]

WARNING

- Be sure to shut off all phases of the external power supply before installation or wiring.
Failure to do so may result in an electric shock or damage to the product.
- Use crimp-contact, pressure-displacement or soldering to wire the connectors for external connections properly using the manufacturer-specified tools.
If the connection is incomplete, it may cause the module to short circuit, catch fire, or malfunction.

CAUTION

- Securely connect the connector to the module.
- Make sure to place the communication and power cables to be connected to the module in a duct or fasten them using a clamp. If the cables are not placed in a duct or fastened with a clamp, their positions may be unstable or moved, and they may be pulled inadvertently. This may damage the module and the cables or cause the module to malfunction because of faulty cable connections.
- Wire the module correctly after confirming the type of the connected interface. If the cable is connected to a different interface or wired incorrectly, it may cause a fire or breakdown.
- When disconnecting the communication and power cables from the module, do not pull the cables by hand. When disconnecting a cable with a connector, hold the connector to the module by hand and pull it out to remove the cable. If the cable is pulled while being connected to the module, it may damage the module and/or cable or make cable contact improper, causing a malfunction.
- Be careful not to let any foreign matter such as wire chips get inside the module. They may cause fire, as well as breakdowns and malfunctions of the module.
- A protective sheet is pasted on the upper part of the module in order to prevent foreign matter such as wire chips to get inside the module while wiring. Do not remove this protective sheet during wiring work. However, be sure to remove the protective sheet before operating the module to allow heat radiation during operation.

[Setup and Maintenance Precautions]

WARNING

- Do not touch the terminals while the power is on. Doing so may cause electric shocks or malfunctions.
- Before cleaning the module or retightening the module mounting screws, make sure to shut off all phases of the external power supply used by the system. Failure to do so may cause the module to electric shocks, breakdown or malfunction. If the screws are loose, it may cause the module to short-circuit, malfunction or fall off. If the screws are tightened excessively, it may damage the screws and cause the module to short circuit, malfunction or fall off.

 CAUTION

- Before performing online operations (especially, program modification, forced output or operating status change) by connecting a peripheral device to a running CPU, read the manual carefully and ensure the safety. Incorrect operation will cause mechanical damage or accidents.
- Never disassemble or modify the module. This may cause breakdowns, malfunctions, injuries or fire.
- When using a wireless communication device such as a cellular phone, keep a distance of 25cm (9.85 inch) or more from the programmable controller in all directions. Failure to do so can cause a malfunction.
- Before mounting/dismounting the module, be sure to shut off all phases of the external power supply used by the system. Failure to do so may cause module failure or malfunctions.
- Do not install/remove the module to/from the base unit more than 50 times after the first use of the product. (IEC 61131-2 compliant)
Failure to do so may cause malfunction.
- Always make sure to touch the grounded metal to discharge the electricity charged in the body, etc., before touching the module.
Failure to do so may cause a failure or malfunctions of the module.

[Operating Precautions]

 CAUTION

- Please read the manual carefully and confirm the safety thoroughly before performing control operations (especially, modifications of data, programs and operation status (status control)) of the programmable controller that is running.
Incorrect modifications of data, programs and operating status may cause system malfunctions, damages to the machines, or accidents.

[Disposal Precautions]

 CAUTION

- Dispose of this product as an industrial waste.

• CONDITIONS OF USE FOR THE PRODUCT •

- (1) Mitsubishi programmable controller ("the PRODUCT") shall be used in conditions;
- i) where any problem, fault or failure occurring in the PRODUCT, if any, shall not lead to any major or serious accident; and
 - ii) where the backup and fail-safe function are systematically or automatically provided outside of the PRODUCT for the case of any problem, fault or failure occurring in the PRODUCT.

- (2) The PRODUCT has been designed and manufactured for the purpose of being used in general industries.

MITSUBISHI SHALL HAVE NO RESPONSIBILITY OR LIABILITY (INCLUDING, BUT NOT LIMITED TO ANY AND ALL RESPONSIBILITY OR LIABILITY BASED ON CONTRACT, WARRANTY, TORT, PRODUCT LIABILITY) FOR ANY INJURY OR DEATH TO PERSONS OR LOSS OR DAMAGE TO PROPERTY CAUSED BY the PRODUCT THAT ARE OPERATED OR USED IN APPLICATION NOT INTENDED OR EXCLUDED BY INSTRUCTIONS, PRECAUTIONS, OR WARNING CONTAINED IN MITSUBISHI'S USER, INSTRUCTION AND/OR SAFETY MANUALS, TECHNICAL BULLETINS AND GUIDELINES FOR the PRODUCT.

("Prohibited Application")

Prohibited Applications include, but not limited to, the use of the PRODUCT in;

- Nuclear Power Plants and any other power plants operated by Power companies, and/or any other cases in which the public could be affected if any problem or fault occurs in the PRODUCT.
- Railway companies or Public service purposes, and/or any other cases in which establishment of a special quality assurance system is required by the Purchaser or End User.
- Aircraft or Aerospace, Medical applications, Train equipment, transport equipment such as Elevator and Escalator, Incineration and Fuel devices, Vehicles, Manned transportation, Equipment for Recreation and Amusement, and Safety devices, handling of Nuclear or Hazardous Materials or Chemicals, Mining and Drilling, and/or other applications where there is a significant risk of injury to the public or property.

Notwithstanding the above, restrictions Mitsubishi may in its sole discretion, authorize use of the PRODUCT in one or more of the Prohibited Applications, provided that the usage of the PRODUCT is limited only for the specific applications agreed to by Mitsubishi and provided further that no special quality assurance or fail-safe, redundant or other safety features which exceed the general specifications of the PRODUCTS are required. For details, please contact the Mitsubishi representative in your region.

REVISIONS

* The manual number is given on the bottom left of the back cover.

Print Date	* Manual Number	Revision
Jan., 2004	SH (NA) -080446ENG-A	First Edition
Mar., 2004	SH (NA) -080446ENG-B	<p>Modifications</p> <p>Section 7.2.2, 8.3.2, 8.4, 8.6, 8.7, 9.2.2, 11.1, 11.4, 11.5</p>
Nov., 2005	SH (NA) -080446ENG-C	<p>Modifications</p> <p>Section 4.3.10, 5.2.1, 6.1, 6.2, 6.6, 7.1, 7.3.1, 7.4.1 to 7.4.5, 8.2.2, 8.3.1, 8.3.3, 8.7.2, 9.1, 10.2, 10.3, 11.1, 11.2, 11.3.2, 11.3.3, 11.4</p>
Feb., 2006	SH (NA) -080446ENG-D	<p>Modifications</p> <p>Section 2.1, 2.4, 10.1</p>
Jan., 2008	SH (NA) -080446ENG-E	<p>Modifications</p> <p>SAFETY PRECAUTIONS, Conformation to the EMC Directive and Low Voltage Instruction, About the Generic Terms and Abbreviations, Section 2.1, 2.5, 3.1, 3.2.1, 5.1, 5.2.1, 5.5, 6.1, 6.4, 6.6, 7.2.2, 7.4.1, 7.4.2, 7.4.4, Chapter 8, Section 9.1.3, 9.3.1, 9.3.2, 9.3.3, 10.2, 10.3, 11.1, 11.2, 11.3.1, 11.3.3, 11.4.1, 11.4.2, 11.5.1</p> <p>Addition</p> <p>Section 2.4</p>
May, 2008	SH (NA) -080446ENG-F	<p>Change of a term</p> <p>"PLC" was changed to "programmable controller".</p> <p>Modifications</p> <p>SAFETY PRECAUTIONS, Compliance with the EMC and Low Voltage Directives, About the Generic Terms and Abbreviations, Section 2.1, 3.1, 6.1, 6.6, 7.4.2, 8.2.1, 8.3.1, 8.3.3, 8.6, 10.2, 10.3, 11.2, 11.3.3, Appendix 3</p>
Nov., 2010	SH (NA)-080446ENG-G	<p>Modifications</p> <p>SAFETY PRECAUTIONS, About the Generic Terms and Abbreviations, Section 2.1, 2.5, 6.3, 6.6, 8.2.1, 11.2, Appendix, WARRANTY</p> <p>Addition</p> <p>CONDITIONS OF USE FOR THE PRODUCT</p>

* The manual number is given on the bottom left of the back cover.

Print Date	* Manual Number	Revision
Oct., 2014	SH (NA)-080446ENG-H	<p data-bbox="614 318 786 349">Modifications</p> <p data-bbox="630 367 1436 622">COMPLIANCE WITH THE EMC AND LOW VOLTAGE DIRECTIVES, ABOUT THE GENERIC TERMS AND ABBREVIATIONS, MEANINGS AND DEFINITIONS OF TERMS, Chapter 1, Section 2.1, 2.2, 2.4, 2.5, 3.1, 3.3.1, 4.3, 4.3.12, 5.1, 6.2, 6.3, 6.5.1, 6.5.2, 6.6, 6.6.1, 7.1, 7.2.2, 7.3.1, 7.4.2, 7.4.4, 8.2.1, 8.2.2, 8.6, 9.1.1, 9.2.2, 9.2.3, 9.3.2, 9.3.3, 10.2, 10.3, 11.1, 11.2, 11.3.2, 11.3.3, Appendix 1</p> <p data-bbox="614 631 724 663">Addition</p> <p data-bbox="630 680 767 712">Appendix 2</p> <p data-bbox="614 721 724 752">Change</p> <p data-bbox="630 770 1238 801">Appendix 2→Appendix 3, Appendix 3→Appendix 4</p>

Japanese Manual Version SH(NA)-080445-J

This manual confers no industrial property rights or any rights of any other kind, nor does it confer any patent licenses. Mitsubishi Electric Corporation cannot be held responsible for any problems involving industrial property rights which may occur as a result of using the contents noted in this manual.

© 2004 MITSUBISHI ELECTRIC CORPORATION

INTRODUCTION

Thank you for purchasing the MELSEC-Q series programmable controller.

Before using the equipment, please read this manual carefully to develop full familiarity with the functions and performance of the Q series programmable controller you have purchased, so as to ensure correct use.

CONTENTS

SAFETY PRECAUTIONS.....	A- 1
CONDITIONS OF USE FOR THE PRODUCT	A- 5
REVISIONS	A- 6
INTRODUCTION.....	A- 8
CONTENTS.....	A- 8
COMPLIANCE WITH THE EMC AND LOW VOLTAGE DIRECTIVES.....	A-12
THE MANUAL'S USAGE AND STRUCTURE	A-12
ABOUT THE GENERIC TERMS AND ABBREVIATIONS	A-14
MEANINGS AND DEFINITIONS OF TERMS.....	A-15
PRODUCT CONFIGURATION.....	A-15
1 OVERVIEW	1- 1 to 1- 5
1.1 Features	1- 1
2 SYSTEM CONFIGURATION	2- 1 to 2- 9
2.1 Applicable Systems.....	2- 1
2.2 Devices Necessary for Network Configuration	2- 3
2.3 System Configuration and Access Range	2- 4
2.4 Precautions for System Configuration.....	2- 6
2.5 Checking Function Version and Software Version	2- 7
3 SPECIFICATIONS	3- 1 to 3-10
3.1 Performance Specifications	3- 2
3.2 I/O Signals for Programmable Controller CPU	3- 3
3.2.1 I/O signal list	3- 3
3.3 Applications and Assignment of Buffer Memory	3- 5
3.3.1 Buffer memory list	3- 5
4 MODBUS® STANDARD FUNCTIONS	4- 1 to 4-20
4.1 MODBUS® Standard Function Support List.....	4- 1
4.2 Frame Specifications	4- 3
4.3 PDU Formats by Functions.....	4- 4
4.3.1 Read coils (FC: 01)	4- 6
4.3.2 Read discrete inputs (FC: 02).....	4- 7
4.3.3 Read holding registers (FC: 03).....	4- 8
4.3.4 Read input registers (FC: 04)	4- 9
4.3.5 Write single coil (FC: 05).....	4-10
4.3.6 Write single register (FC: 06).....	4-11
4.3.7 Write multiple coils (FC: 15).....	4-12

4.3.8 Write multiple registers (FC: 16)	4-14
4.3.9 Read file record (FC: 20) (SC: 06).....	4-15
4.3.10 Write file record (FC: 21) (SC: 06).....	4-17
4.3.11 Mask write register (FC: 22)	4-19
4.3.12 Read/Write multiple registers (FC: 23).....	4-20

5 FUNCTIONS	5- 1 to 5-15
--------------------	---------------------

5.1 Function List	5- 1
5.2 Master Function	5- 3
5.2.1 Automatic communication function.....	5- 3
5.2.2 Dedicated instructions	5- 9
5.3 Slave Function.....	5-10
5.3.1 Automatic response function	5-10
5.3.2 MODBUS [®] device assignment function	5-11
5.4 KeepAlive Function	5-12
5.5 Router Relay Function	5-14
5.6 GX Developer Connection Function.....	5-15

6 PRE-OPERATIONAL PROCEDURES AND SETTING	6- 1 to 6-21
---	---------------------

6.1 Handling Precautions.....	6- 1
6.2 Pre-Operational Procedures and Setting	6- 2
6.3 Part Names	6- 4
6.4 Connection to Ethernet	6- 6
6.5 Unit Tests	6- 8
6.5.1 Hardware test	6- 8
6.5.2 Self-loopback test.....	6- 9
6.6 Intelligent Function Module Switch Setting	6-10
6.6.1 Communication starting conditions depending on basic parameter/MODBUS [®] device assignment parameter starting method setting	6-16

7 PARAMETER SETTING	7- 1 to 7-33
----------------------------	---------------------

7.1 Parameter Settings and Setting Procedure	7- 1
7.2 Basic Parameters	7- 6
7.2.1 Basic parameters details.....	7- 6
7.2.2 TCP/UDP/IP setting	7- 8
7.2.3 GX Developer connection information setting.....	7-16
7.2.4 MODBUS [®] /TCP setting.....	7-17
7.3 Automatic Communication Parameters.....	7-19
7.3.1 Automatic communication parameters details	7-19
7.4 MODBUS [®] Device Assignment Parameters	7-23
7.4.1 MODBUS [®] device sizes.....	7-25
7.4.2 MODBUS [®] device assignment parameters details.....	7-26
7.4.3 Default assignment parameters.....	7-29
7.4.4 MODBUS [®] extended file register assignment.....	7-31
7.4.5 QJ71MT91 buffer memory assignment.....	7-32

8 UTILITY PACKAGE (GX Configurator-MB)	8- 1 to 8-36
---	---------------------

8.1 Functions of the Utility Package	8- 1
8.2 Installing and Uninstalling the Utility Package	8- 2
8.2.1 Handling precautions	8- 2
8.2.2 Operating environment.....	8- 4
8.3 Utility Package Operation	8- 6
8.3.1 Common utility package operations	8- 6
8.3.2 Operation overview	8- 9
8.3.3 Starting the Intelligent function module utility	8-11
8.4 Initial Setting	8-13
8.5 Auto Refresh Setting	8-15
8.6 Monitor/Test	8-17
8.6.1 X/Y Monitor/test.....	8-21
8.6.2 Basic/MODBUS [®] device assignment parameter status	8-23
8.6.3 Automatic communication status	8-24
8.6.4 Error log	8-26
8.6.5 Communication status.....	8-27
8.6.6 PING test	8-29
8.7 Parameter Setting Using GX Configurator-MB	8-30
8.7.1 Basic parameters	8-30
8.7.2 Automatic communication parameters	8-33
8.7.3 MODBUS [®] device assignment parameters.....	8-35

9 PROGRAMMING	9- 1 to 9-49
----------------------	---------------------

9.1 Parameter Setting	9- 1
9.1.1 Basic parameter setting	9- 1
9.1.2 Automatic communication parameter setting	9- 4
9.1.3 MODBUS [®] device assignment parameter setting	9- 7
9.2 Program Example for Normal System Configuration.....	9-11
9.2.1 System configuration and program conditions	9-11
9.2.2 Program using utility package.....	9-18
9.2.3 Program without using utility package	9-22
9.3 Program Example for Use in MELSECNET/H Remote I/O Network	9-29
9.3.1 System configuration and program conditions	9-29
9.3.2 Program using utility package.....	9-35
9.3.3 Program without using utility package	9-39

10 DEDICATED INSTRUCTIONS	10- 1 to 10-18
----------------------------------	-----------------------

10.1 Dedicated Instruction List and Available Devices	10- 1
10.2 Z(P).MBRW	10- 2
10.3 Z(P).MBREQ	10-11

11 TROUBLESHOOTING	11- 1 to 11-48
---------------------------	-----------------------

11.1 Troubleshooting	11- 1
11.2 Confirming QJ71MT91 Status	11-12

11.3 Error Codes	11-15
11.3.1 Error code storage areas	11-15
11.3.2 Exception code list	11-21
11.3.3 Error code list	11-23
11.4 Turning Off the COM.ERR. LED	11-40
11.4.1 From GX Configurator-MB	11-40
11.4.2 Program example for use of sequence program	11-43
11.5 Conducting PING Test to Check QJ71MT91 Connection	11-44
11.5.1 From GX Configurator-MB	11-45
11.5.2 Program example for use of sequence program	11-49

APPENDICES	App- 1 to App- 8
------------	------------------

Appendix 1 External Dimensions.....	App- 1
Appendix 2 Function Upgrade of the QJ71MT91	App- 2
Appendix 3 Processing Time	App- 2
Appendix 4 GX Developer Connection Setup Example	App- 6

INDEX	Index- 1 to Index- 4
-------	----------------------

COMPLIANCE WITH THE EMC AND LOW VOLTAGE DIRECTIVES

(1) Method of ensuring compliance

To ensure that Mitsubishi programmable controllers maintain EMC and Low Voltage Directives when incorporated into other machinery or equipment, certain measures may be necessary. Please refer to one of the following manuals.

- QCPU User's Manual (Hardware Design, Maintenance and Inspection)
- Safety Guidelines

(This manual is included with the CPU module or base unit.)

The CE mark on the side of the programmable controller indicates compliance with EMC and Low Voltage Directives.

(2) Additional measures

To ensure that this product maintains EMC and Low Voltage Directives, please refer to one of the manuals listed under (1).

THE MANUAL'S USAGE AND STRUCTURE

● How to use this manual

This manual describes the pre-operation procedure, functions, etc. by use of the MODBUS® /TCP interface module (QJ71MT91) on a purpose-by-purpose basis. Refer to the corresponding section when you need to know the following:

(1) Features (Chapter 1)

Chapter 1 describes the features of the QJ71MT91.

(2) System configuration (Chapter 2)

- (a) Section 2.1 describes the applicable programmable controller CPUs and compatible software packages.
- (b) Section 2.2 describes the devices necessary to configure a network.
- (c) Section 2.3 describes the system configurations that use the QJ71MT91 and the accessible range.

(3) Performance and specifications (Chapter 3)

- (a) Section 3.1 provides the performance specifications of the QJ71MT91.
- (b) Section 3.2 and 3.3 give the I/O signal and buffer memory lists of the QJ71MT91.

(4) MODBUS® standard functions supported by the QJ71MT91 (Chapter 4)

- (a) Section 4.1 gives a list of MODBUS® standard functions supported by the QJ71MT91.
- (b) Section 4.2 and 4.3 provide the frame specifications of the MODBUS® standard functions supported by the QJ71MT91.

(5) Usable functions (Chapter 5)

Chapter 5 describes the functions of the QJ71MT91.

(6) Settings and procedures necessary to operate the system (Chapter 6)

Chapter 6 describes the pre-operation settings and procedures.

(7) Parameter setting of the QJ71MT91 (Chapter 7)

Chapter 7 describes the parameter setting procedures and parameter details.

(8) Parameter setting from the utility package (Chapter 8)

Chapter 8 describes the utility package operation method.

(9) Parameter setting from sequence programs (Chapter 9)

Chapter 9 describes the I/O signals used for parameter setting, the I/O signal timing charts, and program examples.

(10) Reading/Writing, etc. of MODBUS® device data with sequence programs (Chapter 10)

Chapter 10 describes the dedicated instructions designed to perform read/write, etc. of MODBUS® device data with sequence programs.

(11) Error codes and corresponding corrective actions (Chapter 11)

(a) Section 11.1 describes the troubleshooting.

(b) Section 11.2 describes how to check the module condition.

(c) Section 11.3 describes the error code storage location and details.

(d) Section 11.4 describes how to turn OFF the COM.ERR. LED.

(e) Section 11.5 describes the PING test.

● About the notation of the numerical values used in this manual

Among the numerical values used in this manual, "H" is placed to the right of the units place for hexadecimal notation.

(Example) 10 Decimal

10H ... Hexadecimal

ABOUT THE GENERIC TERMS AND ABBREVIATIONS

Unless otherwise specified, this manual uses the following generic terms and abbreviations to explain the QJ71MT91 MODBUS[®] /TCP interface module.

Generic Term/Abbreviation	Description
QJ71MT91	The abbreviation for the QJ71MT91 MODBUS [®] /TCP interface module
MODBUS [®] /TCP	A generic term for the protocol designed to use MODBUS [®] protocol messages on a TCP/IP network
MODBUS [®] serial protocol	A generic term for the protocol designed to use MODBUS [®] protocol messages on a serial interface
FC	The abbreviation for the function code
SC	The abbreviation for the sub code
Programmable controller CPU	A generic term for the Basic model QCPU, High Performance model QCPU, Process CPU, Redundant CPU, Universal model QCPU
Basic model QCPU	A generic term for the Q00JCPU, Q00CPU and Q01CPU
High Performance model QCPU	A generic term for the Q02CPU, Q02HCPU, Q06HCPU, Q12HCPU and Q25HCPU
Process CPU	A generic term for the Q02PHCPU, Q06PHCPU, Q12PHCPU and Q25PHCPU
Redundant CPU	A generic term for the Q12PRHCPU and Q25PRHCPU
Universal model CPU	A generic term for the Q00UJCPU, Q00UCPU, Q01UCPU, Q02UCPU, Q03UDCPU, Q03UDVCPU, Q03UDECPU, Q04UDHCPU, Q04UDVCPU, Q04UDEHCPU, Q06UDHCPU, Q06UDVCPU, Q06UDEHCPU, Q10UDHCPU, Q10UDEHCPU, Q13UDHCPU, Q13UDVCPU, Q13UDEHCPU, Q20UDHCPU, Q20UDEHCPU, Q26UDHCPU, Q26UDVCPU, Q26UDEHCPU, Q50UDEHCPU, and Q100UDEHCPU
GX Developer	The product name of the software package for the MELSEC programmable controllers
GX Works2	
Ethernet module	The QJ71E71-100 Ethernet interface module
Ethernet Address	A machine-specific address that is also referred to as the MAC (Media Access Control) address. This is used to identify the addresses of external devices over a network. The Ethernet address of the QJ71MT91 can be verified on the MAC ADD column of the rating plate.
MELSECNET/H	The MELSECNET/H network system
Master	The side from which a request is sent to execute a function
Slave	The side where the execution request from the master is processed and its execution result is sent
Master function	The function that allows communication with the MODBUS [®] /TCP compatible slave device as the master of MODBUS [®] /TCP
Slave function	The function that allows communication with the MODBUS [®] /TCP compatible master device as the slave of MODBUS [®] /TCP
Request message	The message used to give a function execution request to the slave. In the MODBUS [®] protocol, a function execution request is given from the master to the slave. A function execution request cannot be given from the slave to the master.
Response message	The message with which the slave returns a function execution result to the master
Target device	A generic term for the communication targets connected for data communication. (personal computer, other QJ71MT91 MODBUS [®] /TCP interface module, MODBUS [®] protocol compatible device, etc.)
Personal computer	The IBM PC/AT or compatible DOS/V-based personal computer
MBRW	The abbreviation for Z.MBRW or ZP.MBRW
MBREQ	The abbreviation for Z.MBREQ or ZP.MBREQ

Generic Term/Abbreviation	Description
Windows® 7	A generic term for Microsoft® Windows® 7 Starter operating system, Microsoft® Windows® 7 Home Premium operating system, Microsoft® Windows® 7 Professional operating system, Microsoft® Windows® 7 Ultimate operating system, and Microsoft® Windows® 7 Enterprise operating system Note that the 32-bit version is specified as "32-bit Windows® 7", and the 64-bit version is specified as "64-bit Windows® 7".
Windows Vista®	A generic term for Microsoft® Windows Vista® Home Basic operating system, Microsoft® Windows Vista® Home Premium operating system, Microsoft® Windows Vista® Business operating system, Microsoft® Windows Vista® Ultimate operating system, and Microsoft® Windows Vista® Enterprise operating system
Windows® XP	A generic term for Microsoft® Windows® XP Professional operating system, and Microsoft® Windows® XP Home Edition operating system

MEANINGS AND DEFINITIONS OF TERMS

The following explains the meanings and definitions of the terms used in this manual.

Term	Meaning/Definition
MODBUS® device	Device used for communication using the MODBUS® protocol
Sequence program	Programming system devised to make a contact type sequence compatible with the programmable controller language as-is. Draw two vertical control buses and describe contacts, etc. between the buses to perform programming.
Device memory	Memory provided for the programmable controller CPU to record the data handled in sequence program operation

PRODUCT CONFIGURATION

The following indicates the product configuration of the QJ71MT91 MODBUS® /TCP interface module.

Model	Item name	Quantity
QJ71MT91	QJ71MT91 MODBUS® /TCP interface module	1
SW1D5C-QMBU-E	GX Configurator-MB Version 1 (1-license product) (CD-ROM)	1
SW1D5C-QMBU-EA	GX Configurator-MB Version 1 (Multiple-license product) (CD-ROM)	1

1 OVERVIEW

1

This manual explains the specifications, functions, programming, troubleshooting, etc. of the MELSEC-Q series QJ71MT91 MODBUS® /TCP interface module (hereafter abbreviated to the QJ71MT91).

The QJ71MT91 is used to connect the MELSEC-Q series programmable controller to a MODBUS® /TCP network.

1.1 Features

(1) Supporting master function of MODBUS® /TCP communication

The QJ71MT91 supports the master function of MODBUS® /TCP communication, which is an open network system for factory automation, and it is compatible with various MODBUS® /TCP slave devices (hereafter abbreviated to the slaves) of other manufactures.

The master function supports the following two functions.

(a) Automatic communication function

By setting the automatic communication parameters, MODBUS® device data can be automatically read from or written to the slaves at the specified intervals using the QJ71MT91 buffer memory. (*1)

Data can be transferred between the QJ71MT91 buffer memory and programmable controller CPU device memory by making the auto refresh setting with the utility package (GX Configurator-MB) or accessing a intelligent function module device with a sequence program.

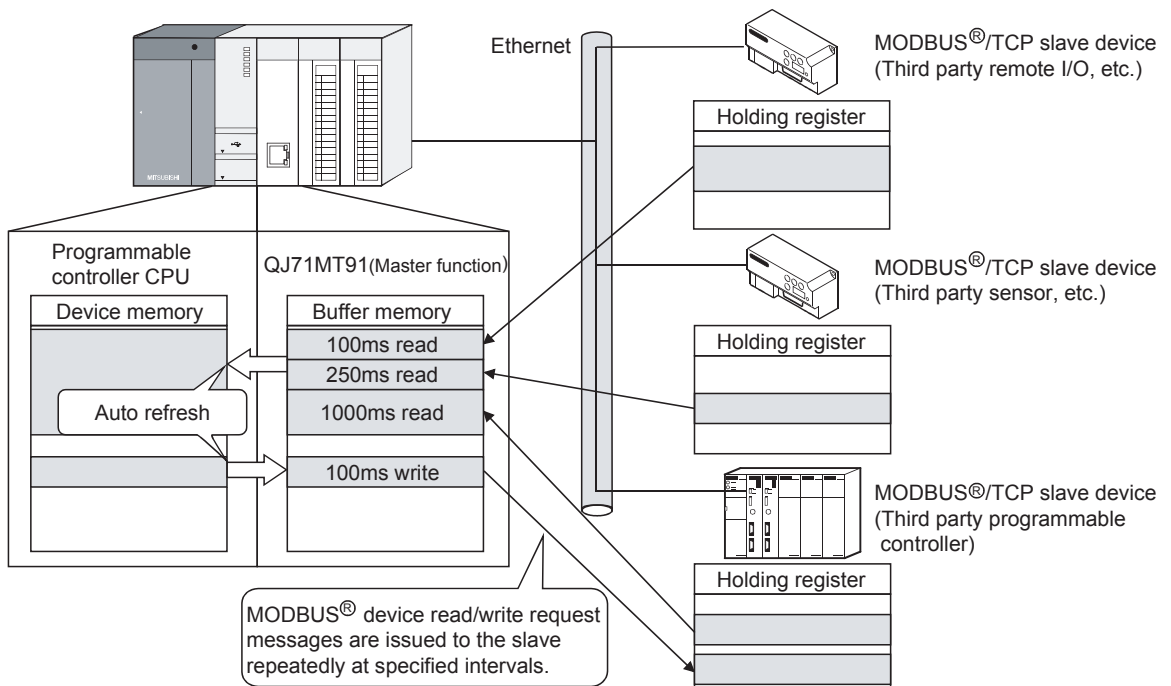

*1: The MODBUS® device indicates the device area of the slave where data can be read/written in response to a request from the master.

(b) Communication using dedicated instruction

Dedicated instructions can be used to make communication from a sequence program at any timing.

The QJ71MT91 supports the following two dedicated instructions.

1) MBRW instruction

Reads/writes MODBUS® device data from/to a slave.

This enables slave data to be read out to the programmable controller CPU device memory or programmable controller CPU data to be written to the slave.

2) MBREQ instruction

Can issue user-desired request message format (function code*1 + data unit) to a slave.

*1: Refer to Chapter 4 for the function code.

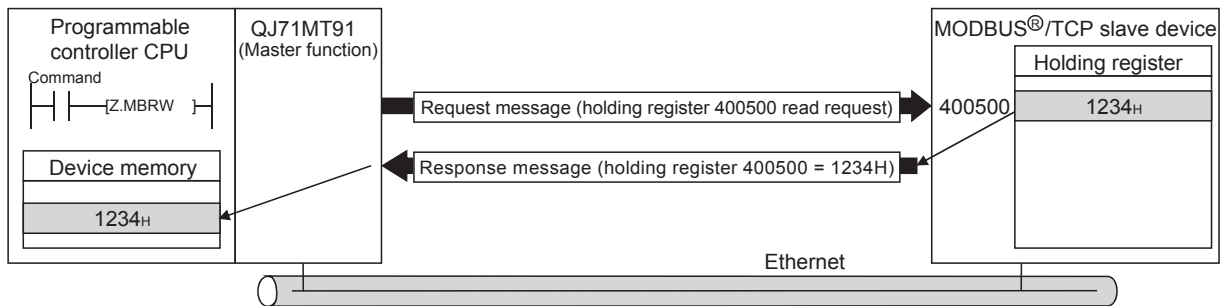

(2) Supporting slave function of MODBUS® /TCP communication

The QJ71MT91 supports the slave function of MODBUS® /TCP communication, which is an open network system for factory automation, and it is compatible with various MODBUS® /TCP master devices (hereafter abbreviated to the masters) of other manufacturers.

The slave function supports the following two functions.

(a) Automatic response function

The QJ71MT91 can automatically respond to a request message received from the master.

A sequence program for the slave function is not needed.

(b) MODBUS® device assignment function

Using MODBUS® device assignment parameters, the MODBUS® devices are correlated with the programmable controller CPU device memory.

This enables direct access from the master to the programmable controller CPU device memory.

Supporting the MODBUS® devices of large capacity, the QJ71MT91 allows all device memories of the programmable controller CPU to be assigned.

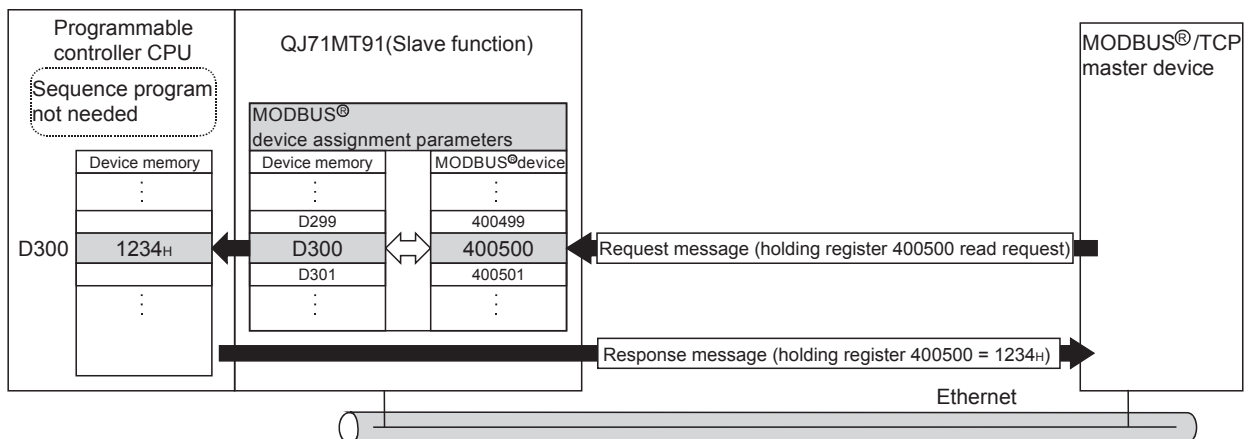

(3) Concurrent operation of master and slave functions

The master and slave functions can be operated concurrently.

This enables flexible construction of a MODBUS® /TCP communication-based system.

(a) Example of communication between QJ71MT91 and third party devices

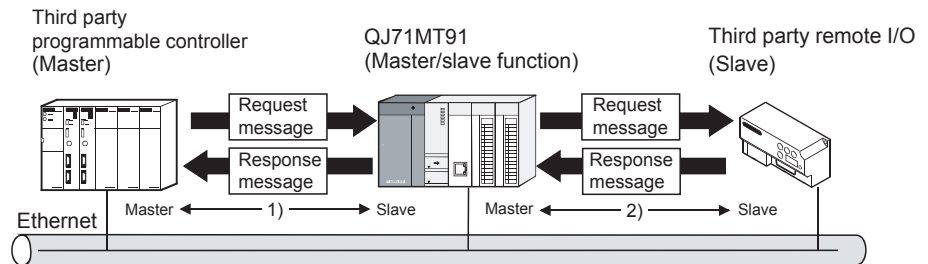

1) In response to a request message from the master, the QJ71MT91 operates as a slave and returns a response message.

2) The QJ71MT91 operates as a master, and issues a request message to the slave.

(b) Example of communication between QJ71MT91 and QJ71MT91

The both functions can be operated bi-directionally between QJ71MT91 and QJ71MT91.

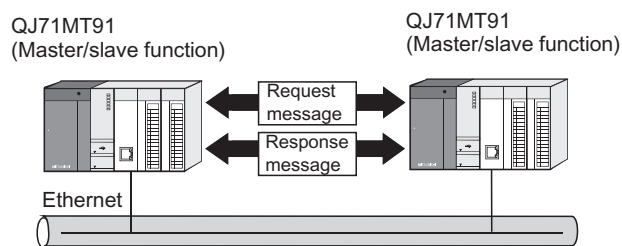

(4) Support of GX Developer connection via Ethernet

GX Developer can be connected to Ethernet via the QJ71MT91.

This enables the maintenance of the programmable controller CPU via Ethernet.

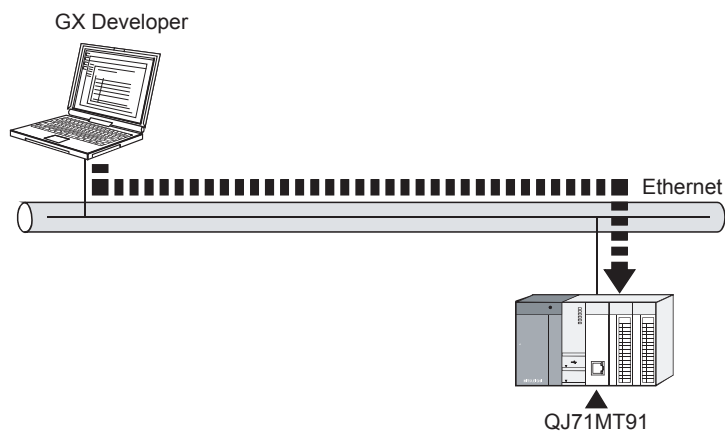

(5) Supporting Ethernet functions for more reliability, high speed communication and flexible system construction

The following Ethernet functions are supported for more reliability, high speed communication and more flexible system construction.

(a) KeepAlive function

The status of communication with the target device where a TCP connection has been established can be checked.

When communication is not made for a given period of time between the QJ71MT91 and the open target device, the QJ71MT91 checks the target device for existence and cuts off unnecessary TCP connections.

(b) 100 Mbps high-speed communication

Supporting 100BASE-TX, the QJ71MT91 can make 100Mbps high-speed communication.

(c) Router relay function

Communication can be made with a MODBUS[®] /TCP device via a router.

(6) Ease of setting with utility package

The optional utility package (GX Configurator-MB) is available.

Though not required, the use of the utility package allows on-screen initial settings (basic parameters, automatic communication parameters, MODBUS[®] device assignment parameters) and auto refresh settings, reducing sequence programs and also facilitating the confirmation of the setting and operating statuses. (*1)

*1: It is recommended to use the utility package with the QJ71MT91.

By making various parameter settings with the utility package, communication can be made without sequence programs.

2 SYSTEM CONFIGURATION

This chapter explains the system configuration of the QJ71MT91.

2.1 Applicable Systems

This section describes the applicable systems.

(1) Applicable modules and base units, and No. of modules

(a) When mounted with a CPU module

For the CPU modules, the number of modules, and base units applicable to the QJ71MT91, refer to the user's manual for the CPU module used.

Note the following when the QJ71MT91 is used with a CPU module.

- Depending on the combination with other modules or the number of mounted modules, power supply capacity may be insufficient. Pay attention to the power supply capacity before mounting modules, and if the power supply capacity is insufficient, change the combination of the modules.
- Mount a module within the number of I/O points for the CPU module. If the number of slots is within the available range, the module can be mounted on any slot.

REMARK

When using a C Controller module, refer to the user's manual for the C Controller module.

(b) Mounting to a MELSECNET/H remote I/O station

For the MELSECNET/H remote I/O station, the number of modules, and base units applicable to the QJ71MT91, refer to the Q Corresponding MELSECNET/H Network System Reference Manual (Remote I/O network).

(2) Support of the multiple CPU system

When using the QJ71MT91 in a multiple CPU system, refer to the QCPU User's Manual (Multiple CPU System) first.

(3) Supported software packages

Relation between the system containing the QJ71MT91 and software package is shown in the following table.

GX Developer or GX Works2 is required to start up the system that uses the QJ71MT91.

		Software version			
		GX Developer * 1	GX Configurator-MB	GX Works2	
Q00J/Q00/Q01CPU	Single CPU system	Version 7 or later	Version 1.00A or later	Refer to the GX Works2 Version 1 Operating Manual (Common).	
	Multiple CPU system	Version 8 or later			
Q02/Q02H/Q06H/ Q12H/Q25HCPU	Single CPU system	Version 4 or later			
	Multiple CPU system	Version 6 or later			
Q02PH/Q06PHCPU	Single CPU system	Version 8.68W or later			
	Multiple CPU system				
Q12PH/Q25PHCPU	Single CPU system	Version 7.10L or later			
	Multiple CPU system				
Q12PRH/Q25PRHCPU	Redundant system	Version 8.45X or later			
Q00UJ/Q00U/Q01UCPU	Single CPU system	Version 8.76E or later			Version 1.08J or later
	Multiple CPU system				
Q02U/Q03UD/Q04UDH/ Q06UDHCPU	Single CPU system	Version 8.48A or later			
	Multiple CPU system				
Q10UDH/Q20UDHCPU	Single CPU system	Version 8.76E or later			
	Multiple CPU system				
Q13UDH/Q26UDHCPU	Single CPU system	Version 8.62Q or later			
	Multiple CPU system				
Q03UDE/Q04UDEH/ Q06UDEH/Q13UDEH/ Q26UDEHCPU	Single CPU system	Version 8.68W or later			
	Multiple CPU system				
Q10UDEH/ Q20UDEHCPU	Single CPU system	Version 8.76E or later			
	Multiple CPU system				
CPU modules other than the above	Single CPU system	Not supported	Not supported		
	Multiple CPU system				
When mounted to MELSECNET/H remote I/O station		Version 6.01B or later	Version 1.00A or later		

*1: For the accessible range of GX Developer, refer to Section 2.3.

POINT

When using GX Works2, refer to the following:

- GX Works2 Version 1 Operating Manual (Common)
- GX Works2 Version 1 Operating Manual (Intelligent Function Module)

2.2 Devices Necessary for Network Configuration

This section explains the devices that configure a network.

Please note that the network must be installed by qualified networking specialists to take sufficient safety measures.

The 10BASE-T or 100BASE-TX can be used to connect the QJ71MT91 to a network.

The QJ71MT91 will distinguish between 10BASE-T and 100BASE-TX, and between the full duplex and half duplex communication mode according to the hub type.

However, for connection with the hub that does not have the auto negotiation function, set the half duplex communication mode on the hub side.

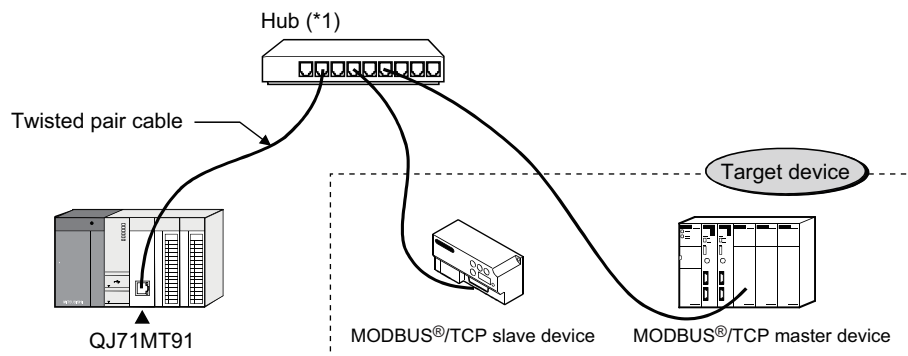

*1: For the number of cascade connection stages, refer to the Section 3.1.

Use the devices that comply with the IEEE802.3 100BASE-TX/10BASE-T Standard.

(1) Hub and other equipment

(a) Shielded twisted pair cable

1) For 100BASE-TX

Shielded twisted pair cable (STP cable), Category 5

2) For 10BASE-T

Unshielded twisted pair cable (UTP cable), Category 3 (4, 5)

A straight cable can be used.

(We do not guarantee proper operation if a crossing cable is used for the 100BASE-TX/10BASE-T connection between the QJ71MT91 and the target device.)

(b) RJ45 jack

(c) Hub for 100Mbps/10Mbps network

POINT

In high-speed communication (100Mbps) by the 100BASE-TX connection, a communication error may occur under the influence of high frequency noise from devices other than the programmable controller in the installation environment. Take the following action on the QJ71MT91 side to prevent the influence of high frequency noise in the construction of a network system.

(1) Wiring connection

- Do not install a twisted pair cable together with the main circuit and power cables, etc.
- Place the twisted pair cable in a duct.

(2) Communication system

- Increase the number of communication retries if necessary.
- Change the hub used for connection into a 10Mbps hub, and make communication at a transmission speed of 10Mbps.

2.3 System Configuration and Access Range

This section provides the system configurations using the QJ71MT91. (*1)
 The target devices available for communication with the QJ71MT91 are the following two kinds of devices.

- Master/slave device supporting the MODBUS® /TCP protocol
- Personal computer running GX Developer

*1: Ethernet devices can also be installed on the Ethernet line where the MODBUS® /TCP system exists. (However, communication with the QJ71MT91 is not available.)

(1) Basic system configuration (MODBUS® /TCP communication)

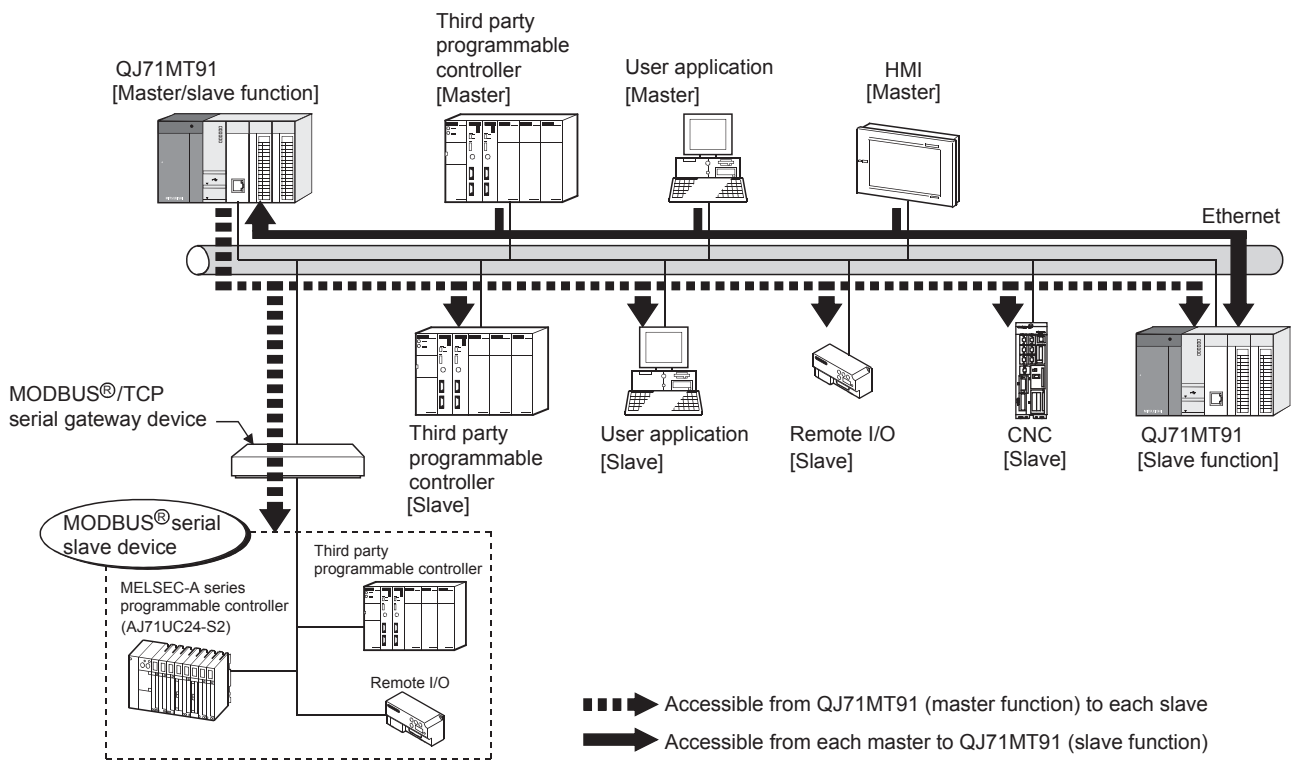

(2) GX Developer connection

(a) Accessible range of GX Developer

Refer to Appendix 3 for the GX Developer connection setup examples.

[Access path via QJ71MT91]

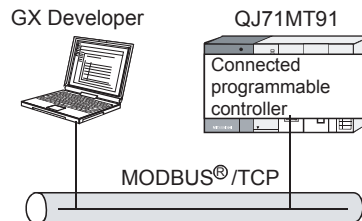

(b) Precautions for GX Developer connection

When the QJ71MT91 and Ethernet module exist together on the same Ethernet, access cannot be made between the QJ71MT91 and Ethernet module.

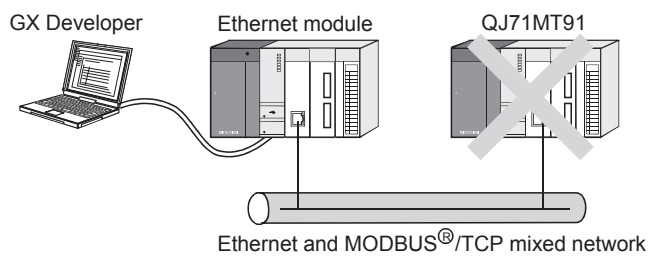

2.4 Precautions for System Configuration

(1) For use in a redundant system

When using the QJ71MT91 in a redundant system, refer to the QnPRHCPU User's Manual (Redundant System).

2.5 Checking Function Version and Software Version

This section describes checking methods for the function version of the QJ71MT91 and the software version of GX Configurator-MB.

(1) Checking the function version of the QJ71MT91

The serial number and function version of the QJ71MT91 can be checked on the rating plate, front of the module, or system monitor window in GX Developer.

(a) Checking on the rating plate

The rating plate is located on the side of the QJ71MT91.

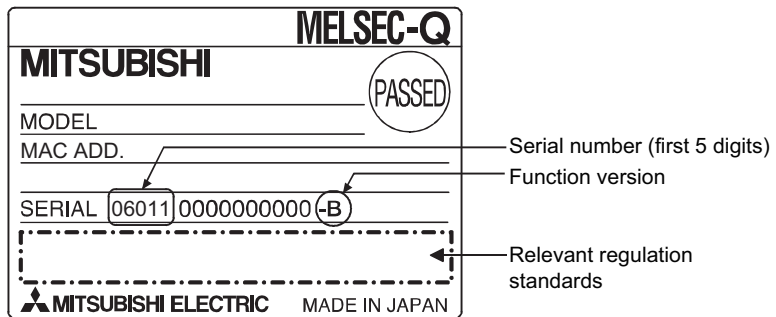

(b) Checking on the front of the module

The serial number and function version on the rating plate is printed on the front (at the bottom) of the module.

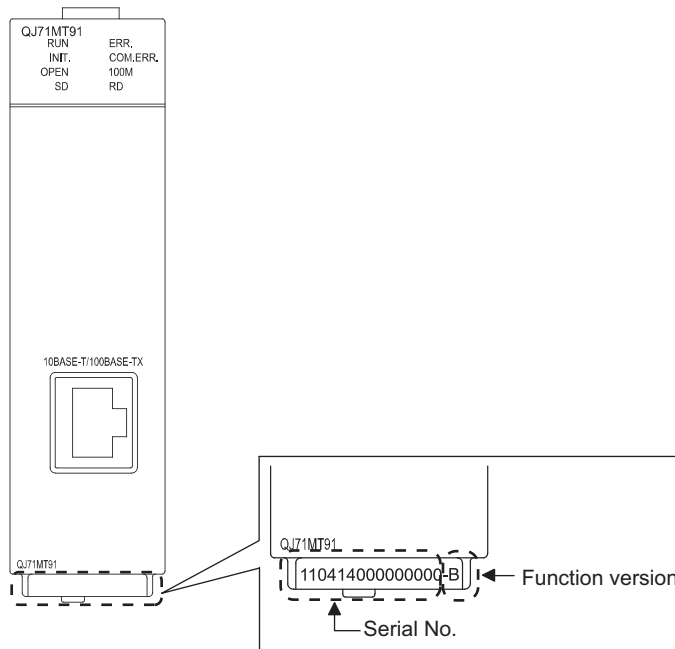

(c) Checking on the System Monitor screen (Product Information List)

To display the system monitor, select [Diagnostics] → [System monitor] → Product Inf. List button of GX Developer.

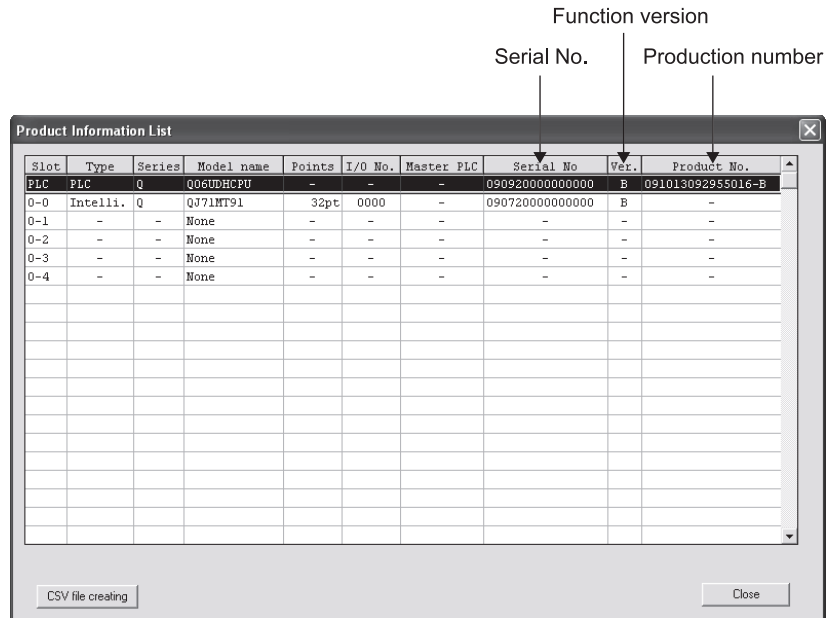

1) Production number display

Since the QJ71MT91 does not support the production number display, “-” is displayed.

POINT

The serial number displayed on the Product Information List screen of GX Developer may differ from that on the rating plate or on the front of the module.

- The serial number on the rating plate or on the front of the module indicates the management information of the product.
- The serial number displayed on the Product Information List screen indicates the functional information of the product.

The functional information of the product will be updated when a function is added.

(2) Checking the software version of GX Configurator-MB

The software version of GX Configurator-MB can be checked in GX Developer's "Product information" screen.

[Operating procedure]

GX Developer → [Help] → [Product information]

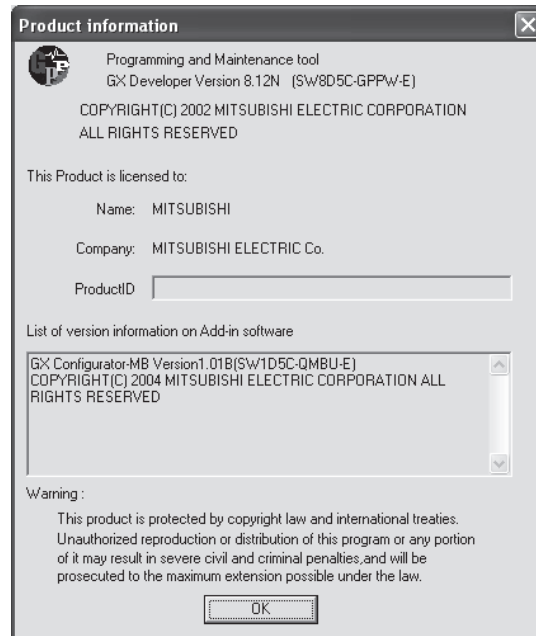

← Software version

3 SPECIFICATIONS

This chapter explains the QJ71MT91's performance specifications, I/O signals for programmable controller CPU, and buffer memory.

For general specifications, refer to QCPU User's Manual (Hardware Design, Maintenance and Inspection).

3.1 Performance Specifications

This section provides the performance specifications of the QJ71MT91.

Item		Specifications		Reference Section	
		10BASE-T	100BASE-TX		
Transmission specifications	Data transmission rate	10Mbps	100Mbps	—	
	Transmission method	Base band			
	Maximum node-to-node distance	200m (656.16ft.)			
	Maximum segment length * 1	100m (328.08ft.)			
	Number of cascade connection stages	Max. 4 stages * 2	Max. 2 stages * 2		
	Maximum number of connections * 3	64 connections			
	Number of routers that can be set	1 default router + any 8 routers			
	Cable	Cable compliant with the IEEE802.3 10BASE-T Standard (unshielded twisted pair cable (UTP cable), Category 3 (4, 5))	Cable compliant with the IEEE802.3 100BASE-TX Standard (shielded twisted pair cable (STP cable), Category 5)	Section 2.2	
Connector applicable for external wiring		RJ45		—	
Master function	Automatic communication function	Number of slaves * 4	64 slaves	—	
		Function (for send)	7 functions	Chapter 4	
		Input area size	4k words	Section 3.3.1	
		Output area size	4k words		
	Dedicated instruction	Number of instructions that can be executed concurrently * 5	Up to 8 instructions		—
		Function (for send)	MBRW instruction: 9 functions MBREQ instruction: 19 functions		Chapter 4
		Input area size	Max. 253 bytes per instruction		Chapter 4
		Output area size	Max. 253 bytes per instruction		
Slave function	Automatic response function	Function (for receive)	12 functions	Chapter 4	
	MODBUS® device size	Coil	64k points	Section 7.4.1	
		Input	64k points		
		Input register	64k points		
		Holding register	64k points		
		Extended file register	Max. 4086k points		
No. of simultaneously acceptable request messages	64		—		
GX Developer connection function	Number of simultaneously connectable GX Developers	Max. 8 GX Developers		Section 7.2.3	
Number of occupied I/O points		32 points		—	
5VDC internal current consumption		0.52A		—	
External dimensions		98 (3.86 in.) (H) × 27.4 (1.08 in.) (W) × 90 (3.54 in.) (D) [mm]		Appendix 1	
Weight		0.11kg		—	

- *1: Length between a hub and a node.
- *2: This is the maximum number of cascade connection stages when a repeater hub is used. For the maximum number of cascade connection stages, contact to the manufacturer for the switching hub used.
- *3: Indicates the number of TCP connections that can be established simultaneously.
- *4: Indicates the maximum number of slaves that can be communication targets.
- *5: Indicates the maximum number of dedicated instructions that can be started simultaneously from a sequence program.



3.2 I/O Signals for Programmable Controller CPU

This section explains the I/O signals of the QJ71MT91 for the programmable controller CPU.

3.2.1 I/O signal list

The following table shows the I/O signals of the QJ71MT91.

The following I/O signal assignment is based on the case where the start I/O No. of the QJ71MT91 is "0000" (installed to slot 0 of the main base unit).

Device X represents an input signal from the QJ71MT91 to the programmable controller CPU.

Device Y shows an output signal from the programmable controller CPU to the QJ71MT91.

Refer to the corresponding reference sections for details.

Signal Direction QJ71MT91 → Programmable controller CPU			Signal Direction Programmable controller CPU → QJ71MT91		
Device No.	Signal name	Reference section	Device No.	Signal name	Reference section
X0	Module READY *1 ON : Accessible OFF: Inaccessible	Section 11.1	Y0	Use prohibited	—
X1	Basic parameter setting, normally completed ON : Normally completed OFF: —	Section 9.1.1	Y1	Basic parameter setting request ON : Being requested OFF: Not requested	Section 9.1.1
X2	Basic parameter setting, error completed ON : Error completed OFF: —		Y2	Use prohibited	—
X3	Basic parameter setting existence ON : Parameters set OFF: No parameters set		Y3		—
X4	Automatic communication parameter setting, normally completed ON : Normally completed OFF: —	Section 5.2.1, 9.1.2	Y4	Automatic communication parameter setting request/automatic communication start request ON : Parameter setting being requested/start being requested OFF: No parameter setting requested/no start requested	Section 5.2.1, 9.1.2
X5	Automatic communication parameter setting, error completed ON : Error completed OFF: —		Y5	Use prohibited	—
X6	Automatic communication operation status ON : Operating OFF: Stopped		Y6	Automatic communication stop request ON : Being requested OFF: Not requested	Section 5.2.1
X7	Automatic communication error status ON : Error occurred OFF: No error	Section 5.2.1	Y7	Use prohibited	—
X8	MODBUS® device assignment parameter setting, normally completed ON : Normally completed OFF: —	Section 9.1.3	Y8	MODBUS® device assignment parameter setting request ON : Being requested OFF: Not requested	Section 9.1.3
X9	MODBUS® device assignment parameter setting, error completed ON : Error completed OFF: —		Y9	Use prohibited	—

*1: Turns ON when the QJ71MT91 is ready after the programmable controller is turned ON from OFF or after the programmable controller CPU is reset.

(Continued on next page)

Signal Direction QJ71MT91 → Programmable controller CPU			Signal Direction Programmable controller CPU → QJ71MT91		
Device No.	Signal name	Reference section	Device No.	Signal name	Reference section
XA	MODBUS [®] device assignment parameter setting existence ON : Parameters set OFF: No parameters set	Section 9.1.3	YA		—
XB	Use prohibited	—	YB	Use prohibited	—
XC		—	YC		—
XD		—	YD		—
XE		—	YE		—
XF		—	YF		—
X10		—	Y10		—
X11		—	Y11		—
X12		—	Y12		—
X13		—	Y13		—
X14		—	Y14		—
X15		—	Y15		—
X16		—	Y16		—
X17		—	Y17		—
X18		—	Y18		—
X19	—	Y19	—		
X1A	—	Y1A	—		
X1B	COM.ERR.LED status ON : Lit OFF: Not lit	Section 11.4.2	Y1B	COM. ERR. LED OFF request ON : Being requested OFF: Not requested	Section 11.4.2
X1C	PING test completed ON : PING test completed OFF: —	Section 11.5.2	Y1C	PING test execution request ON : PING test execution being requested OFF: PING test execution not request	Section 11.5.2
X1D	Use prohibited	—	Y1D	Use prohibited	—
X1E		—	Y1E		—
X1F	Watch dog timer error ON : Module error occurred OFF: Module operating normally	Section 11.1	Y1F		—

Important
Among the I/O signals for the programmable controller CPU, do not output (turn ON) the "Use prohibited" signals. Doing so may cause the programmable controller system malfunction.

3.3 Applications and Assignment of Buffer Memory

3.3.1 Buffer memory list

A buffer memory list is given below.

Address	Application	Name	Initial Value	Read/Write (*1)	Initial Setting (*2)	Reference Section			
0000 _H (0)	Basic parameter	TCP/UDP/IP monitoring timer	TCP ULP timer value Set time = set value × 500ms	3C _H (60)	R/W	○	Section 7.2		
0001 _H (1)			TCP zero window timer value Set time = set value × 500ms	14 _H (20)	R/W				
0002 _H (2)			TCP resend timer value Set time = set value × 500ms	14 _H (20)	R/W				
0003 _H (3)			TCP end timer value Set time = set value × 500ms	28 _H (40)	R/W				
0004 _H (4)			IP reassembly timer value Set time = set value × 500ms	A _H (10)	R/W				
0005 _H (5)			Split reception monitoring timer value Set time = set value × 500ms	3C _H (60)	R/W				
0006 _H (6)		KeepAlive	KeepAlive	1 _H	R/W				
0007 _H (7)			KeepAlive start timer value Set time = set value × 500ms	4B0 _H (1200)	R/W				
0008 _H (8)			KeepAlive interval timer value Set time = set value × 500ms	14 _H (20)	R/W				
0009 _H (9)			KeepAlive resend count	3 _H	R/W				
000A _H (10)		TCP/UDP/IP setting	Routing information	Router relay function	0 _H			R/W	
000B _H to 000C _H (11 to 12)				Subnet mask pattern	FFFFFFF0 _H			R/W	
000D _H to 000E _H (13 to 14)				Default router IP address	0 _H			R/W	
000F _H (15)				Number of routers set	0 _H			R/W	
0010 _H to 0011 _H (16 to 17)			Router information 1	Subnet address	0 _H			R/W	
0012 _H to 0013 _H (18 to 19)				Router IP address	0 _H			R/W	
0014 _H to 002F _H (20 to 47)			Router information 2 to 8	(Same as router information 1)					
0030 _H (48)			GX Developer connection information setting	Number of TCP connections for GX Developer connection	1 _H			R/W	○
0031 _H to 010F _H (49 to 271)		System area (use prohibited)		—	—			—	—

(Continued on next page)

*1: Indicates whether the address is readable and/or writable from/to a sequence program.

R: Readable W: Writable

*2: Indicates whether setting on GX Configurator-MB is enabled or disabled.

○: Setting enabled ×: Setting disabled

Address	Application		Name	Initial Value	Read /Write (* 1)	Initial Setting (* 2)	Reference Section	
0110 _H (272)	Basic parameter	MODBUS® /TCP setting	Local slave station port No.	502	R/W	○	Section 7.2	
0111 _H (273)			Target slave port No. for automatic communication function	502	R/W			
0112 _H to 0113 _H (274 to 275)			System area (use prohibited)	—	—	—	—	
0114 _H (276)			CPU response monitoring timer value Set time = set value × 500ms	A _H (10)	R/W	○	Section 7.2	
0115 _H to 0116 _H (277 to 278)			Preferred node specification 1	IP address	0 _H			R/W
				Number of connections	0 _H			R/W
0117 _H (279)			Preferred node specification 2	(Same as preferred node specification 1)				
0118 _H to 01D4 _H (280 to 468)	Preferred node specification 2 to 64	(Same as preferred node specification 1)						
01D5 _H to 01FF _H (469 to 511)	System area (use prohibited)		—	—	—	—		
0200 _H to 0201 _H (512 to 513)	Automatic communication parameter	Automatic communication parameter 1	Target station IP address	00000000	R/W	○	Section 7.3	
0202 _H (514)			Module ID	255 _H	R/W			
0203 _H (515)			Repeat interval timer value Set time = set value × 10ms	0	R/W			
0204 _H (516)			Response check timer value Set time = set value × 500ms	0	R/W			
0205 _H (517)			Target MODBUS® device type specification	0000 _H	R/W			
0206 _H (518)			Read setting	Head buffer memory address	0000 _H			R/W
				Target MODBUS® device head number	0			R/W
				Access points	0			R/W
0209 _H (521)			Write setting	Head buffer memory address	0000 _H			R/W
				Target MODBUS® device head number	0			R/W
				Access points	0			R/W
020A _H (522)			Automatic communication parameter 2 to 64	(Same as automatic communication parameter 1)				
020B _H (523)								
020C _H to 04FF _H (524 to 1279)	System area (use prohibited)		—	—	—	—		
0500 _H to 08FF _H (1280 to 2303)	System area (use prohibited)		—	—	—	—		

(Continued on next page)

Address	Application		Name	Initial Value	Read/Write (*1)	Initial Setting (*2)	Reference Section
0900 _H (2304)	MODBUS [®] device assignment parameter	Coil assignment 1	Device code	0 _H	R/W	○	Section 7.4
0901 _H (2305)			Head device number	0 _H	R/W		
0902 _H (2306)			Head coil number	0 _H	R/W		
0903 _H (2307)			Assignment points	0 _H	R/W		
0904 _H to 093F _H (2308 to 2367)		Coil assignment 2 to 16	(Same as coil assignment 1)				
0940 _H (2368)		Input assignment 1	Device code	0 _H	R/W	○	
0941 _H (2369)			Head device number	0 _H	R/W		
0942 _H (2370)			Head input number	0 _H	R/W		
0943 _H (2371)			Assignment points	0 _H	R/W		
0944 _H to 097F _H (2372 to 2431)		Input assignment 2 to 16	(Same as input assignment 1)				
0980 _H (2432)		Input register assignment 1	Device code	0 _H	R/W	○	
0981 _H (2433)			Head device number	0 _H	R/W		
0982 _H (2434)			Head input register number	0 _H	R/W		
0983 _H (2435)			Assignment points	0 _H	R/W		
0984 _H to 09BF _H (2436 to 2495)		Input register assignment 2 to 16	(Same as input register assignment 1)				
09C0 _H (2496)		Holding register assignment 1	Device code	0 _H	R/W	○	
09C1 _H (2497)	Head device number		0 _H	R/W			
09C2 _H (2498)	Head holding register number		0 _H	R/W			
09C3 _H (2499)	Assignment points		0 _H	R/W			
09C4 _H to 09FF _H (2500 to 2559)	Holding register assignment 2 to 16	(Same as holding register assignment 1)					
0A00 _H to 0BFF _H (2560 to 3071)	System area (use prohibited)			—	—	—	—
0C00 _H (3072)	Setting status	Intelligent function module switch setting status	Switch 1: Operation mode setting status	Intelligent function module switch status	R	×	Section 6.6 Section 11.2
0C01 _H (3073)			Switch 2: Communication condition setting status		R		
0C02 _H (3074)			Switch 3: Local station IP address setting status		R		
0C03 _H (3075)			Switch 4: Local station IP address setting status		R		
0C04 _H (3076)			Switch 5: Redundant setting status		R		

(Continued on next page)

Address	Application	Name	Initial Value	Read/Write (*1)	Initial Setting (*2)	Reference Section			
0C05 _H (3077)	Operating status	Module status	LED ON status	LED ON status	R	Section 6.3 Section 11.2			
0C06 _H to 0C0F _H (3078 to 3087)		System area (use prohibited)		—	—	—	—		
0C10 _H (3088)		Parameter error information	Basic parameter error code storage area		0 _H	R	× Section 11.3.1		
0C11 _H (3089)			Automatic communication parameter error code storage area		0 _H	R			
0C12 _H (3090)			Automatic communication parameter setting result storage area		0 _H	R			
0C13 _H (3091)			MODBUS [®] device assignment parameter error code storage area		0 _H	R			
0C14 _H (3092)			MODBUS [®] device assignment parameter setting result storage area	Error, device type	0 _H	R			
0C15 _H (3093)				Error, assigned group No.	0 _H	R			
0C16 _H to 0C1F _H (3094 to 3103)		System area (use prohibited)		—	—	—	—		
0C20 _H to 0C23 _H (3104 to 3107)		Communication status monitor area	Automatic communication operation status storage area (parameters 1 to 64)		0 _H	R	× Section 11.3.1		
0C24 _H to 0C27 _H (3108 to 3111)			System area (use prohibited)		—	—	—	—	
0C28 _H to 0C67 _H (3112 to 3175)			Automatic communication error code storage area (parameters 1 to 64)		0 _H	R	× Section 11.3.1		
0C68 _H to 0CA7 _H (3176 to 3239)			System area (use prohibited)		—	—	—	—	
0CA8 _H to 0CFD _H (3240 to 3325)		System area (use prohibited)		—	—	—	—		
0CFE _H (3326)		Error log	Number of errors occurred		0 _H	R	× Section 11.3.1		
0CFF _H (3327)			Error log write pointer		0 _H	R			
0D00 _H (3328)			Error log 1	Detailed error code		0 _H		R	
0D01 _H (3329)				Exception code		0 _H		R	
0D02 _H (3330)				Function code		0 _H		R	
0D03 _H (3331)				Local station port No.		0 _H		R	
0D04 _H to 0D05 _H (3332 to 3333)				Target IP address		0 _H		R	
0D06 _H (3334)				Target device port No.		0 _H		R	
0D07 _H (3335)				System area (use prohibited)		—		—	—
0D08 _H to 0DFE _H (3336 to 3583)			Error log 2 to 32	(Same as error log 1)		—		—	× Section 11.3.1

(Continued on next page)

Address	Application		Name	Initial Value	Read /Write (*1)	Initial Setting (*2)	Reference Section	
0E00 _H to 0E02 _H (3584 to 3586)	H / W information	Ethernet address	Local station Ethernet address	Ethernet address	R	×	—	
0E03 _H to 0E0F _H (3587 to 3599)	System area (use prohibited)			—	—	—	—	
0E10 _H to 0E11 _H (3600 to 3601)	Communi- cation status	Communi- cation status by protocol type	IP	IP packet reception count	0 _H	R	×	Section 11.3.1
0E12 _H to 0E13 _H (3602 to 3603)				Count of IP packet reception discarded due to sum check error	0 _H	R		
0E14 _H to 0E15 _H (3604 to 3605)				Total number of sent IP packets	0 _H	R		
0E16 _H to 0E29 _H (3606 to 3625)				System area (use prohibited)	—	—	—	—
0E2A _H to 0E2B _H (3626 to 3627)				Simultaneous transmission error detection count	0 _H	R	×	Section 11.3.1
0E2C _H to 0E2F _H (3628 to 3631)				System area (use prohibited)	—	—	—	—
0E30 _H to 0E31 _H (3632 to 3633)			ICMP	ICMP packet reception count	0 _H	R	×	Section 11.3.1
0E32 _H to 0E33 _H (3634 to 3635)				Count of ICMP packet reception discarded due to sum check error	0 _H	R		
0E34 _H to 0E35 _H (3636 to 3637)				Total number of sent ICMP packets	0 _H	R		
0E36 _H to 0E37 _H (3638 to 3639)				Total number of ICMP echo request received	0 _H	R		
0E38 _H to 0E39 _H (3640 to 3641)				Total number of ICMP echo reply sent	0 _H	R		
0E3A _H to 0E3B _H (3642 to 3643)				Total number of ICMP echo request sent	0 _H	R		
0E3C _H to 0E3D _H (3644 to 3645)				Total number of ICMP echo reply received	0 _H	R		
0E3E _H to 0E4F _H (3646 to 3663)				System area (use prohibited)	—	—		
0E50 _H to 0E51 _H (3664 to 3665)			TCP	TCP packet reception count	0 _H	R	×	Section 11.3.1
0E52 _H to 0E53 _H (3666 to 3667)				Count of TCP packet reception discarded due to sum check error	0 _H	R		
0E54 _H to 0E55 _H (3668 to 3669)	Total number of sent TCP packets	0 _H		R				
0E56 _H to 0E6F _H (3670 to 3695)	System area (use prohibited)	—		—	—	—		

(Continued on next page)

Address	Application		Name		Initial Value	Read/Write (*1)	Initial Setting (*2)	Reference Section	
0E70 _H to 0E71 _H (3696 to 3697)	Communication status	Communication status by protocol type	UDP	UDP packet reception count	0 _H	R	×	Section 11.3.1	
Count of UDP packet reception discarded due to sum check error				0 _H	R				
Total number of sent UDP packets				0 _H	R				
0E72 _H to 0E73 _H (3698 to 3699)				System area (use prohibited)	—	—	—	—	
0E74 _H to 0E75 _H (3700 to 3701)									
0E76 _H to 0E79 _H (3702 to 3705)									
0E7A _H to 0E83 _H (3706 to 3715)									
0E84 _H to 0E85 _H (3716 to 3717)									
0E86 _H to 0E87 _H (3718 to 3719)	Receive error		Framing error count	0 _H	R	×	Section 11.3		
0E88 _H to 0E89 _H (3720 to 3721)			Overflow count	0 _H	R				
0E8A _H to 0E8F _H (3722 to 3727)			CRC error count	0 _H	R				
0E90 _H to 0FD _{FH} (3728 to 4063)			System area (use prohibited)	—	—	—	—		
0FE0 _H (4064)	PING test		Communication time check		2 _H	R/W	×	Section 11.5	
0FE1 _H (4065)			Transmission count		4 _H	R/W			
0FE2 _H to 0FE3 _H (4066 to 4067)			IP address		0 _H	R/W			
0FE4 _H (4068)			Result	Execution result	0 _H	R			
0FE5 _H (4069)				Total packet transmission count	0 _H	R			
0FE6 _H (4070)				Success count	0 _H	R			
0FE7 _H (4071)				Failure count	0 _H	R			
0FE8 _H to 0FFF _H (4072 to 4095)	System area (use prohibited)	—	—	—	—				
1000 _H to 1FFF _H (4096 to 8191)	Automatic communication function buffer	Automatic communication function buffer input area	0 _H	R	×	Section 5.2.1			
2000 _H to 2FFF _H (8192 to 12287)		System area (use prohibited)	—	—	—	—			
3000 _H to 3FFF _H (12288 to 16383)		Automatic communication function buffer output area	0 _H	R/W	×	Section 5.2.1			
4000 _H to 4FFF _H (16384 to 20479)		System area (use prohibited)	—	—	—	—			
5000 _H to 5FFF _H (20480 to 24575)	User free area		0 _H	R/W	×	Section 7.4.5			

4 MODBUS® STANDARD FUNCTIONS

This chapter explains the MODBUS® standard functions supported by the QJ71MT91.

4.1 MODBUS® Standard Function Support List

(1) MODBUS® standard function support list

The following table indicates a list of the MODBUS® standard functions supported by the QJ71MT91.

Function Code (Sub Code)	Function	Processing	Reference
01	Read coils	Reads the statuses (ON/OFF) of one or more coils.	Section 4.3.1
02	Read discrete inputs	Reads the statuses (ON/OFF) of one or more inputs.	Section 4.3.2
03	Read holding registers	Reads the values of one or more holding registers.	Section 4.3.3
04	Read input registers	Reads the values of one or more input registers.	Section 4.3.4
05	Write single coil	Writes a value (ON/OFF) to one coil.	Section 4.3.5
06	Write single register	Writes a value to one holding register.	Section 4.3.6
07 *1 *2	Read exception status	Reads error statuses indicated by eight coils.	—
08 *1 *2	Diagnostics	Executes various diagnostics. The diagnostics results are returned to the master.	—
11 *1 *2	Get communications event counter	Gets the communication event counter.	—
12 *1 *2	Get communications event log	Gets the communication event log.	—
15	Write multiple coils	Writes values (ON/OFF) to multiple coils.	Section 4.3.7
16	Write multiple registers	Writes values to multiple holding registers.	Section 4.3.8
17 *1 *2	Report slave I.D	Reads the type, status, etc. of the slave device to the master.	—
20(6)	Read file record	Reads the values of one or more extended file registers.	Section 4.3.9
21(6)	Write file record	Writes values to one or more extended file registers.	Section 4.3.10
22	Mask write register	Masks the value stored in one holding register with AND or OR, and writes a value.	Section 4.3.11
23	Read/write multiple registers	Reads and writes values from and to multiple holding registers.	Section 4.3.12
24 *1	Read FIFO queue	Reads values from the holding registers in FIFO queue structure.	—
43 *1	Read device identification	Reads the module identification information of the slave.	—

*1: The QJ71MT91 slave function does not support this function.

However, it can be issued from the master (QJ71MT91) by use of the MBREQ instruction.

*2: The function codes 07, 08, 11, 12 and 17 are the functions dedicated to the MODBUS® serial protocol.

(2) Standard function support list by master and slave functions

The following table indicates a standard function support list classified by the master and slave functions of the QJ71MT91.

Function Code (Sub Code)	Function	Master Function *3			Slave Function
		Automatic communication function	MBRW instruction *4	MBREQ instruction *4	
01	Read coils	○	○	○	○*5
02	Read discrete inputs	○	○	○	○*5
03	Read holding registers	○	○	○	○*5
04	Read input registers	○	○	○	○*5
05	Write single coil	×	×	○	○*5
06	Write single register	×	×	○	○*5
07 *1 *2	Read exception status	×	×	○	×
08 *1 *2	Diagnostics	×	×	○	×
11 *1 *2	Get communications event counter	×	×	○	×
12 *1 *2	Get communications event log	×	×	○	×
15	Write multiple coils	○	○	○	○*5
16	Write multiple registers	○	○	○	○*5
17 *1 *2	Report slave I.D	×	×	○	×
20(6)	Read file record	×	○	○	○*6
21(6)	Write file record	×	○	○	○*6
22	Mask write register	×	×	○	○*5
23	Read/write multiple registers	○	○	○	○*5
24 *1	Read FIFO queue	×	×	○	×
43 *1	Read device identification	×	×	○	×

○: Supported ×:Not supported

*1: The QJ71MT91 slave function does not support this function.

However, it can be issued from the master (QJ71MT91) by use of the MBREQ instruction.

*2: The function codes 07, 08, 11, 12 and 17 are the functions dedicated to the MODBUS® serial protocol.

*3: For details of the function codes for the master function, refer to the explanation of the corresponding function.

*4: The dedicated instructions are unavailable for the QJ71MT91 mounted on a MELSECNET/H remote I/O station.

*5: This function has a limit in the slave function when the QJ71MT91 is mounted on a MELSECNET/H remote I/O station.

An exception response will result if a device unsupported by the MELSECNET/H remote I/O station is assigned as a MODBUS® device and an access request is made from the master station.

In this case, an error code will be stored into the error log of the QJ71MT91, and an exception code will be returned to the master.

*6: This function is not supported when the QJ71MT91 is mounted on a MELSECNET/H remote I/O station.

4.2 Frame Specifications

The frame specifications of MODBUS® /TCP are indicated below.

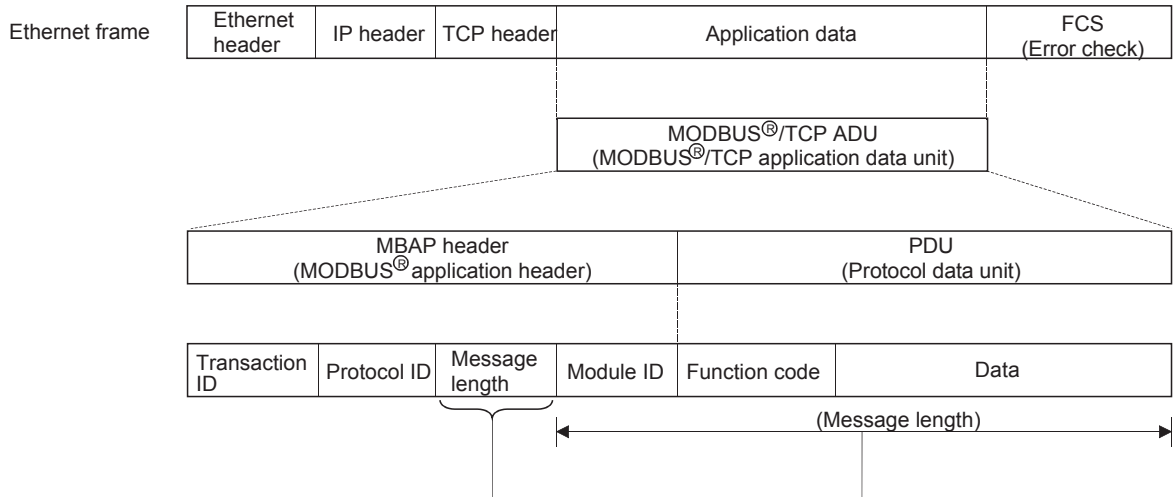

Area Name		Area Size	Description
MBAP header (MODBUS® application header)	Transaction ID	2 bytes	Used by the master for matching of the response message from the slave.
	Protocol ID	2 bytes	Indicates the protocol of the PDU (protocol data unit). Stores 0 in the case of MODBUS® /TCP.
	Message length	2 bytes	Stores the message size in byte unit. The message length after this field is stored. (See the above figure.)
	Module ID	1 byte	Used to specify the slave connected to the other line, e.g. MODBUS® serial protocol.
PDU (Protocol data unit)	Function code	1 byte	The master specifies the processing to be performed for the slave.
	Data	1 to 252 bytes	[When master sends request message to slave] Stores the requested processing. [When slave sends response message to master] Stores the result of processing execution.

4.3 PDU Formats by Functions

This section explains the PDU (protocol data unit) formats of the MODBUS® standard functions.

(1) Precautions for specifying device number in message

When specifying a device number in a message, specify "(device number) - 1". However, it does not apply to the file number and device number specified for Read/Write file record.

(Example) When the status of input 32 (100032) is read with Read discrete inputs (FC: 02)

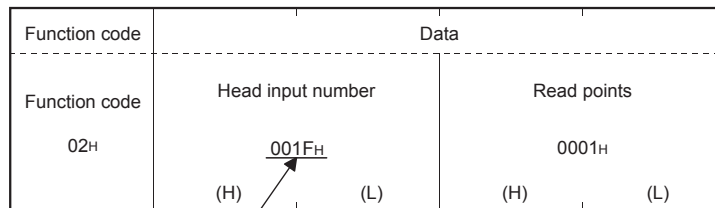

Specify 31 (001FH) for the head input number to read the input 32 (100032) status.

The device number stored in the response message is "(actually read/written device number) - 1".

(2) Overview of request/response message format given in this section

(a) Request/response message format diagram

The following indicates the overview of the request/response message format diagram given in Section 4.3.1 to 4.3.12.

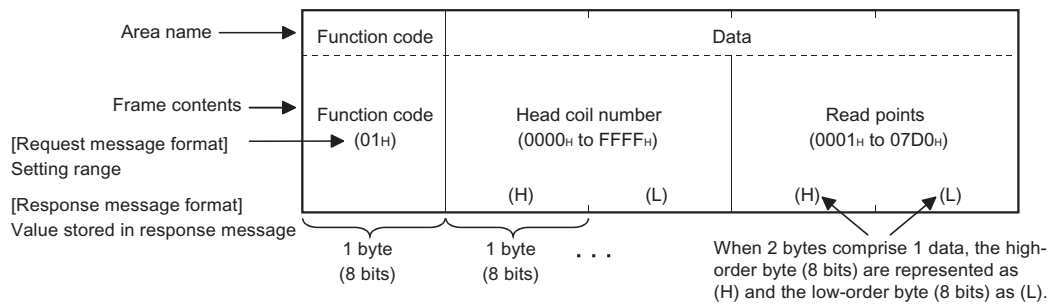

(b) Response message format

The format of a response message issued by the slave to the master differs depending on whether the processing in the slave has been completed normally or not.

In Section 4.3.1 to 4.3.12, the formats for normal completion and error completion are provided.

(3) Storage location of exception code and error code

On error completion of processing in the slave (QJ71MT91), an exception code is sent to the master. (Refer to the "Response message format (when completed with an error)" given in Section 4.3.1 to 4.3.12.)

The exception code is also stored into the QJ71MT91 buffer memory.

Further, to allow the cause to be identified in more detail, the error code is stored into the QJ71MT91 buffer memory.

The exception code and error code can be confirmed in the error log area (address: CFE_H to DFF_H) of the buffer memory.

REMARK

(1) Refer to Section 11.3 for the confirmation method and details of the exception code and error code.

(2) Refer to Section 4.2 for details of the PDU (protocol data unit).

4.3.1 Read coils (FC: 01)

Reads the statuses (ON/OFF) of one or more coils.

Number of accessible devices with one message
1 to 2000 points

(1) Request message format (Master → Slave)

Function code	Data			
Function code (01 _H)	Head coil number (0000 _H to FFFF _H)		Read points (0001 _H to 07D0 _H)	
	(H)	(L)	(H)	(L)

(2) Response message format (Slave → Master)
(When completed normally)

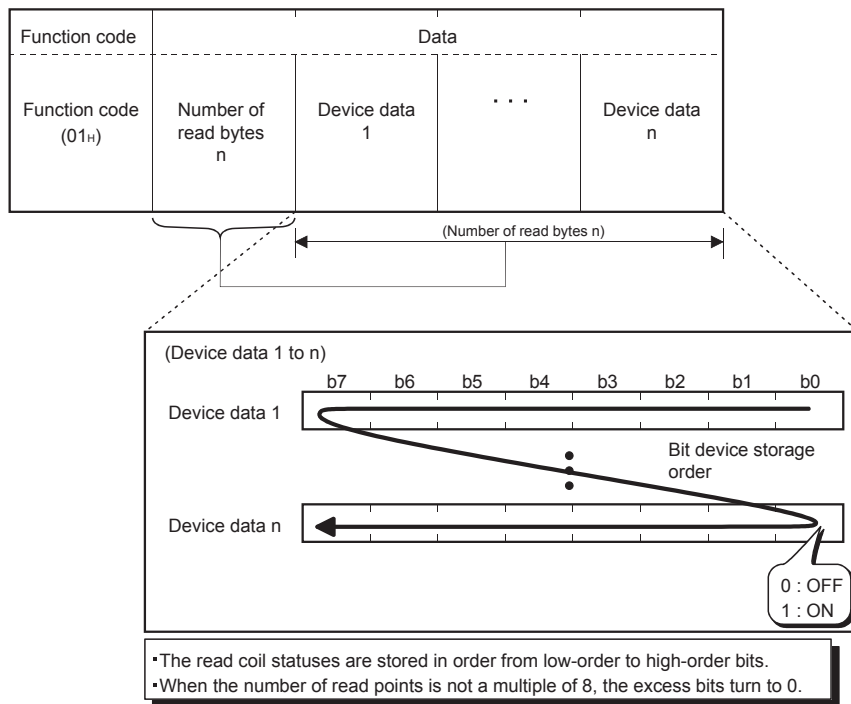

(When completed with an error)

Function code	Data
Function code (81 _H)	Exception code*

※: When completed with an error, the exception code and error code are stored into the buffer memory.

Refer to Section 11.3 for the storage location, confirmation method and more details.

4.3.2 Read discrete inputs (FC: 02)

Reads the statuses (ON/OFF) of one or more inputs.

Number of accessible devices with one message
1 to 2000 points

(1) Request message format (Master → Slave)

Function code	Data			
Function code (02H)	Head input number (0000H to FFFFH)		Read points (0001H to 07D0H)	
	(H)	(L)	(H)	(L)

(2) Response message format (Slave → Master)
(When completed normally)

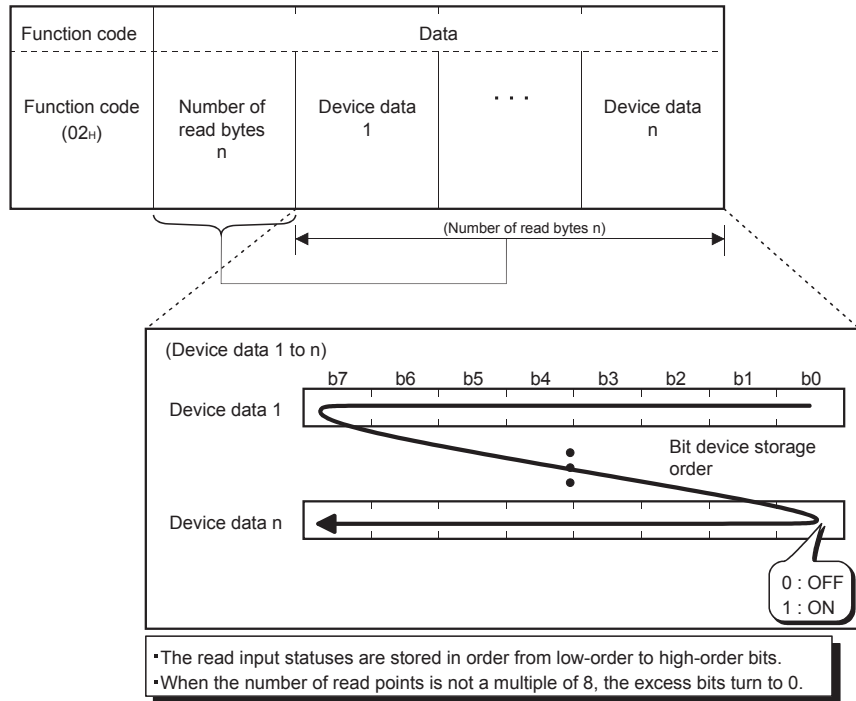

(When completed with an error)

Function code	Data
Function code (82H)	Exception code*

*: When completed with an error, the exception code and error code are stored into the buffer memory.

Refer to Section 11.3 for the storage location, confirmation method and more details.

4.3.3 Read holding registers (FC: 03)

Reads the values of one or more holding registers.

Number of accessible devices with one message
1 to 125 points

(1) Request message format (Master → Slave)

Function code	Data			
Function code (03H)	Head holding register number (0000H to FFFFH)		Read points (0001H to 007DH)	
	(H)	(L)	(H)	(L)

(2) Response message format (Slave → Master)

(When completed normally)

Function code	Data			
Function code (03H)	Number of read bytes $n \times 2^{*1}$	Device data 1		Device data n
		(H)	(L)	(H) (L)

(Number of read bytes $n \times 2$)

*1: For example, when $n = 4$, the number of read bytes is $4 \times 2 = 8$ bytes.

(When completed with an error)

Function code	Data
Function code (83H)	Exception code*

*2: When completed with an error, the exception code and error code are stored into the buffer memory.

Refer to Section 11.3 for the storage location, confirmation method and more details.

4.3.4 Read input registers (FC: 04)

Reads the values of one or more input registers.

Number of accessible devices with one message
1 to 125 points

(1) Request message format (Master → Slave)

Function code	Data			
Function code (04 _H)	Head input register number (0000 _H to FFFF _H)		Read points (0001 _H to 007D _H)	
	(H)	(L)	(H)	(L)

(2) Response message format (Slave → Master)

(When completed normally)

Function code	Data					
Function code (04 _H)	Number of read bytes $n \times 2^*1$	Device data 1		...	Device data n	
		(H)	(L)		(H)	(L)

(Number of read bytes $n \times 2$)

*1: For example, when $n = 4$, the number of read bytes is $4 \times 2 = 8$ bytes.

(When completed with an error)

Function code	Data
Function code (84 _H)	Exception code*

*2: When completed with an error, the exception code and error code are stored into the buffer memory.

Refer to Section 11.3 for the storage location, confirmation method and more details.

4.3.5 Write single coil (FC: 05)

Writes a value (ON/OFF) to one coil.

Number of accessible devices with one message
1 point

(1) Request message format (Master → Slave)

Function code	Data			
Function code (05H)	Coil number (0000H to FFFFH)		ON/OFF specification (0000H : OFF) (FF00H : ON)	
	(H)	(L)	(H)	(L)

(2) Response message format (Slave → Master)

(When completed normally)

The slave returns the request message received from the master as it is.

(When completed with an error)

Function code	Data
Function code (85H)	Exception code*

*: When completed with an error, the exception code and error code are stored into the buffer memory.

Refer to Section 11.3 for the storage location, confirmation method and more details.

4.3.6 Write single register (FC: 06)

Writes a value to one holding register.

Number of accessible devices with one message
1 point

(1) Request message format (Master → Slave)

Function code	Data			
Function code (06H)	Holding register number (0000H to FFFFH)		Write data (0000H to FFFFH)	
	(H)	(L)	(H)	(L)

(2) Response message format (Slave → Master)

(When completed normally)

The slave returns the request message received from the master as it is.

(When completed with an error)

Function code	Data
Function code (86H)	Exception code*

※: When completed with an error, the exception code and error code are stored into the buffer memory.

Refer to Section 11.3 for the storage location, confirmation method and more details.

4.3.7 Write multiple coils (FC: 15)

Writes values (ON/OFF) to multiple coils.

Number of accessible devices with one message
1 to 1968 points

(1) Request message format (Master → Slave)

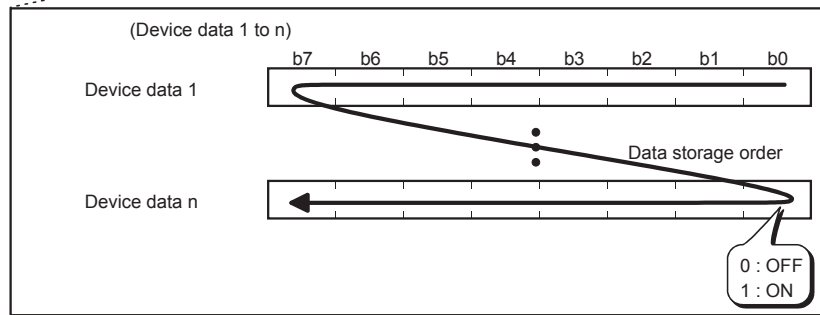
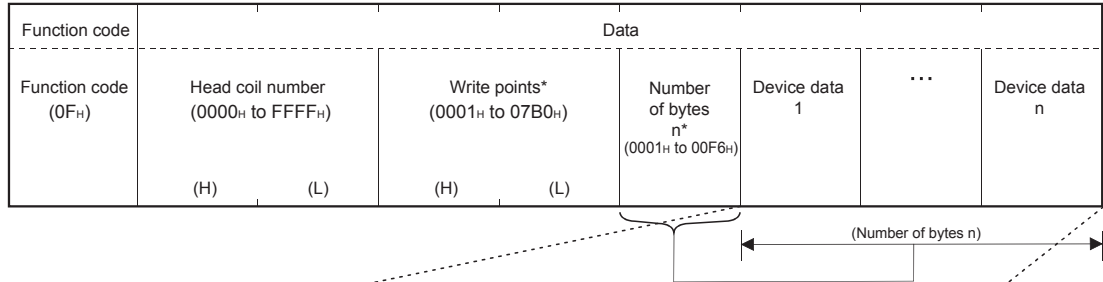

The values (ON/OFF) stored into the device data 1 to n are written to the coils in order from low-order to high-order bits of the device data.

※: The number of points specified as the write points must be matched with the number of bits specified as the number of bytes.
For example, when the write points are 16, set the number of bytes to 2 bytes (= 16 bits).

(2) Response message format (Slave → Master)
(When completed normally)

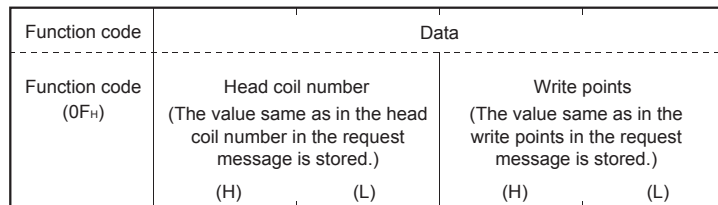

(When completed with an error)

Function code	Data
Function code (8FH)	Exception code*

※: When completed with an error, the exception code and error code are stored into the buffer memory.

Refer to Section 11.3 for the storage location, confirmation method and more details.

4.3.8 Write multiple registers (FC: 16)

Writes values to multiple holding registers.

Number of accessible devices with one message
1 to 123 points

(1) Request message format (Master → Slave)

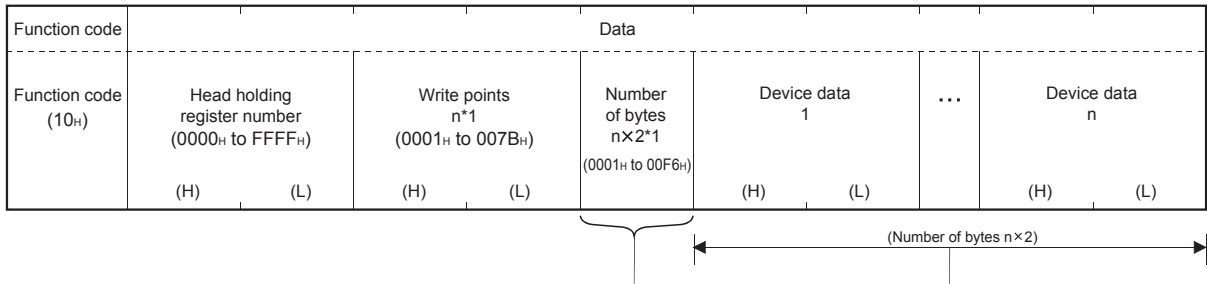

*1: The number of points specified as the write points must be matched with the number of bytes.

(2) Response message format (Slave → Master)

(When completed normally)

Function code	Data			
Function code (10H)	Head holding register number (The value same as in the request message is stored.)		Write points (The value same as in the request message is stored.)	
	(H)	(L)	(H)	(L)

(When completed with an error)

Function code	Data
Function code (90H)	Exception code*2

*2: When completed with an error, the exception code and error code are stored into the buffer memory.

Refer to Section 11.3 for the storage location, confirmation method and more details.

4.3.9 Read file record (FC: 20) (SC: 06)

Reads the values of one or more extended file registers.

Number of accessible devices with one message
1 to 124 points

(1) Request message format (Master → Slave)

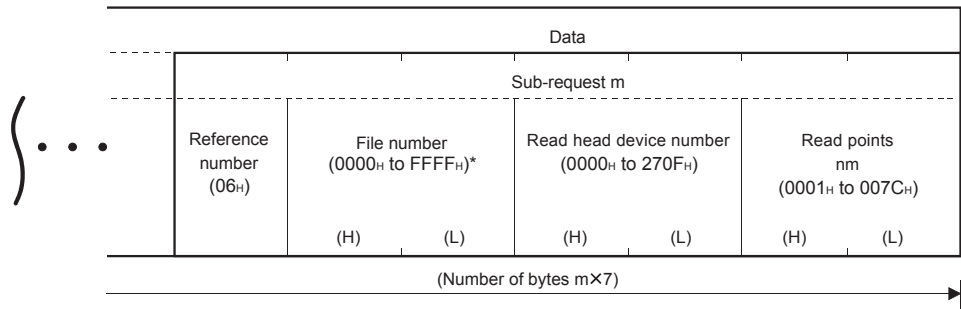
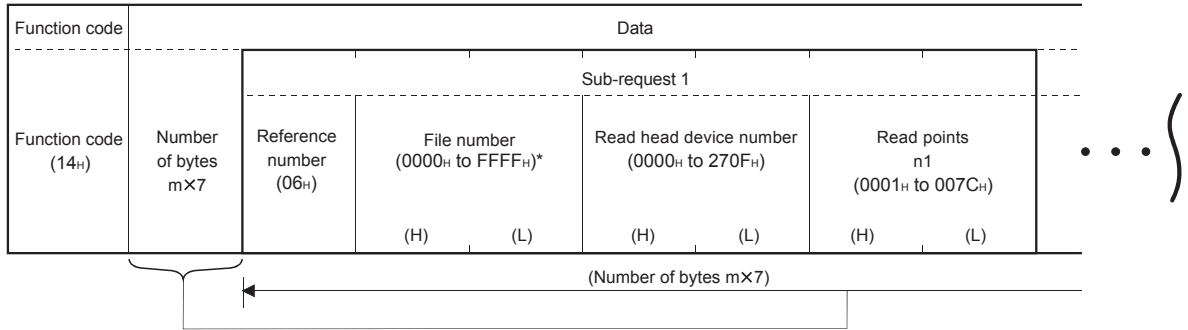

*: The upper limit of the file number available for the QJ71MT91 slave function is equal to the file register size of the mounted programmable controller CPU. (Refer to Section 7.4.4.)

- (a) Specify the number of sub-requests "m" so that the PDU (protocol data unit) size in the request message does not exceed 253 bytes.

$$2 + m \times 7 \leq 253$$

If the above condition is not satisfied, the request message is discarded.

- (b) Specify the total read points of all the sub-requests, "N (n1 + . . . + nm)" so that the PDU (protocol data unit) size in the request message does not exceed 253 bytes.

$$2 + m \times 2 + N \times 2 \leq 253$$

If the above condition is not satisfied, the slave returns an exception response.

(2) Response message format (Slave → Master)
(When completed normally)

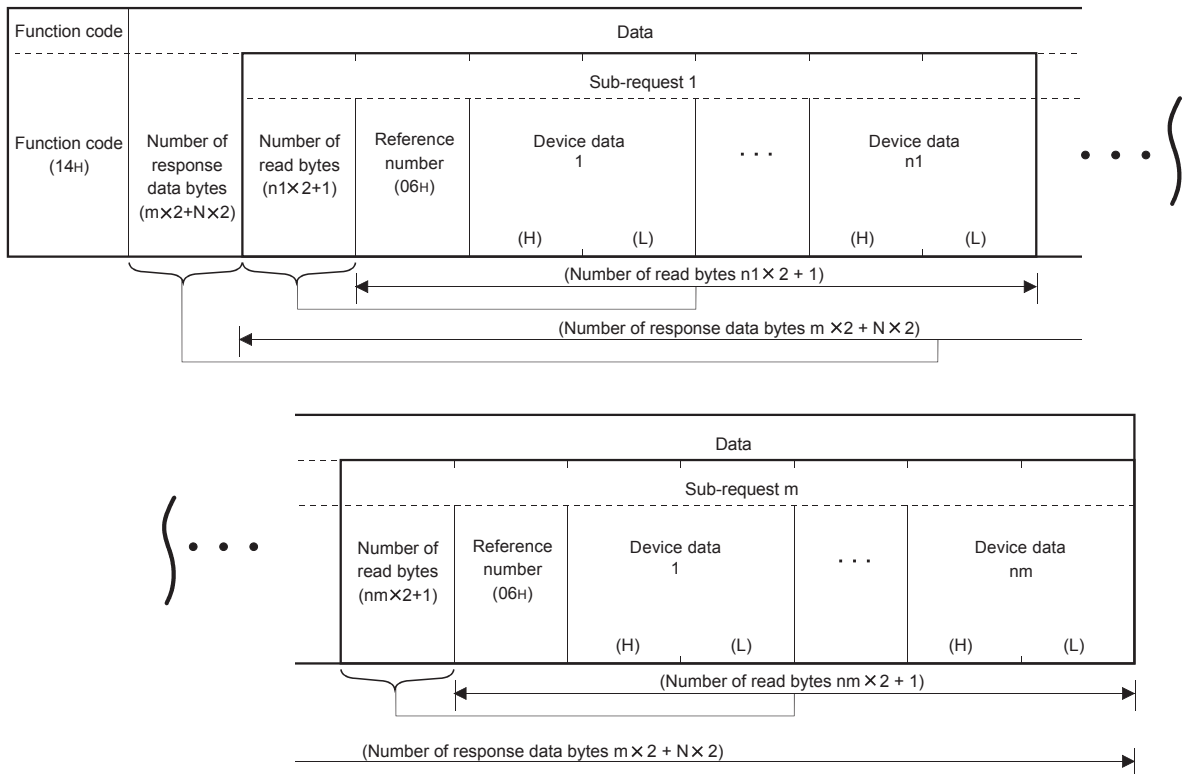

"N" in the above diagram represents the total ($n_1 + \dots + n_m$) of the device data.

(When completed with an error)

Function code	Data
Function code (94H)	Exception code*

*: When completed with an error, the exception code and error code are stored into the buffer memory.

Refer to Section 11.3 for the storage location, confirmation method and more details.

4.3.10 Write file record (FC: 21) (SC: 06)

Writes values to one or more extended file registers.

Number of accessible devices with one message
1 to 122 points

(1) Request message format (Master → Slave)

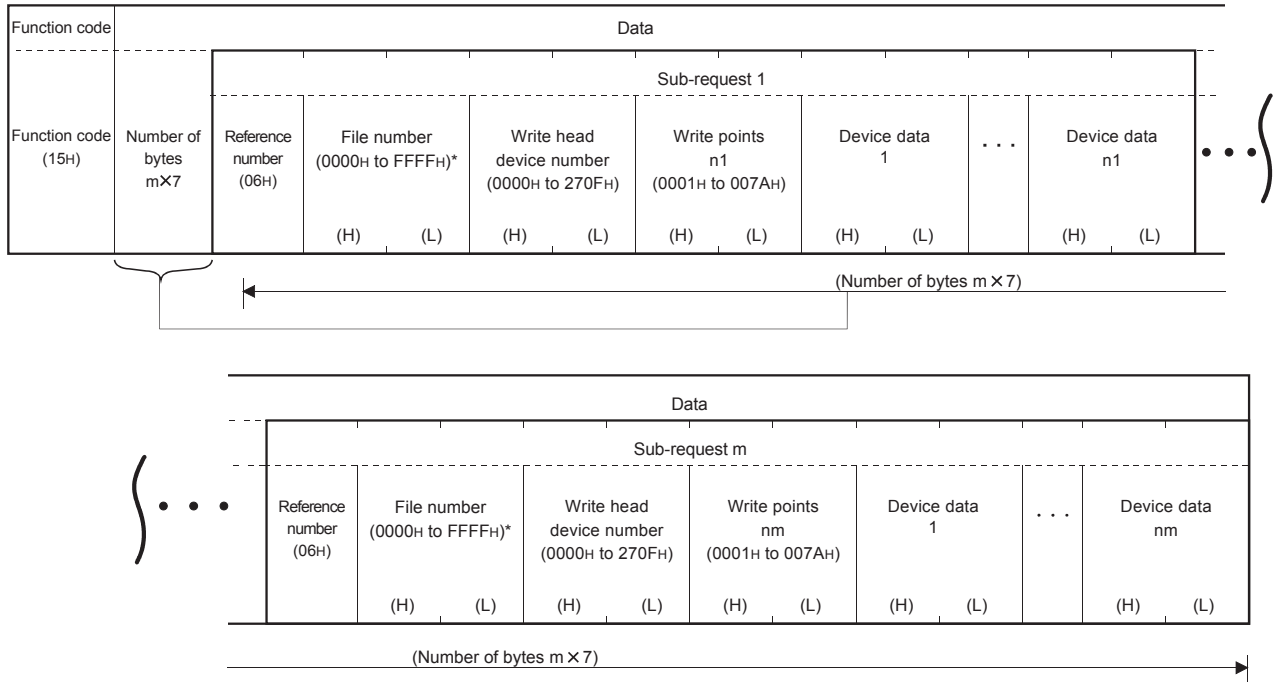

※: The upper limit of the file number available for the QJ71MT91 slave function is equal to the file register size of the mounted programmable controller CPU. (Refer to Section 7.4.4.)

- (a) Specify the total write points of all the sub-requests, N (n1 + . . . + nm) so that the size of the PDU (protocol data unit) in the request message does not exceed 253 bytes.

$$2 + m \times 7 + N \times 2 \leq 253$$

If the above condition is not satisfied, the request message is discarded.

(2) Response message format (Slave → Master)

(When completed normally)

The slave returns the request message received from the master as it is.

(When completed with an error)

Function code	Data
Function code (95H)	Exception code*

※: When completed with an error, the exception code and error code are stored into the buffer memory.

Refer to Section 11.3 for the storage location, confirmation method and more details.

POINT

Even if the slave (QJ71MT91) receives this function with the programmable controller CPU file register (ZR) set as read only (for example, the storage location of the file register [ZR] is a Flash card), the slave responds normally.

In this case, however, the Write file record is not performed.

When performing the Write file record, previously confirm whether the programmable controller CPU file register (ZR) is writable.

4.3.11 Mask write register (FC: 22)

Masks the value stored in one holding register with AND or OR, and writes the masked value.

Number of accessible devices with one message
1 point

The masked value is written to the holding register as described below.
 (Target register's current value \cap AND mask value) \cup (OR mask value \cap AND mask value)
 = write value

When the OR mask value is 0000H, only the AND processing of the AND mask value is performed.

When the AND mask value is 0000H, the OR mask value becomes the write value.

(1) Request message format (Master → Slave)

Function code	Data					
Function code (16H)	Target holding register number (0000H to FFFFH)		AND mask value (0000H to FFFFH)		OR mask value (0000H to FFFFH)	
	(H)	(L)	(H)	(L)	(H)	(L)

(2) Response message format (Slave → Master)

(When completed normally)

The slave returns the request message received from the master as it is.

(When completed with an error)

Function code	Data
Function code (96H)	Exception code*

*: When completed with an error, the exception code and error code are stored into the buffer memory.

Refer to Section 11.3 for the storage location, confirmation method and more details.

POINT
This function code reads the value stored in the holding register from the slave, and after AND/OR processing in the master, writes the masked value to the holding register of the slave. Therefore, when the holding register value is changed during AND/OR processing, the new value is overwritten.

4.3.12 Read/Write multiple registers (FC: 23)

Reads and writes data from and to multiple holding registers.
Write is executed first and read is then executed.

Number of accessible devices with one message
Read: 1 to 125 points
Write: 1 to 121 points

(1) Request message format (Master → Slave)

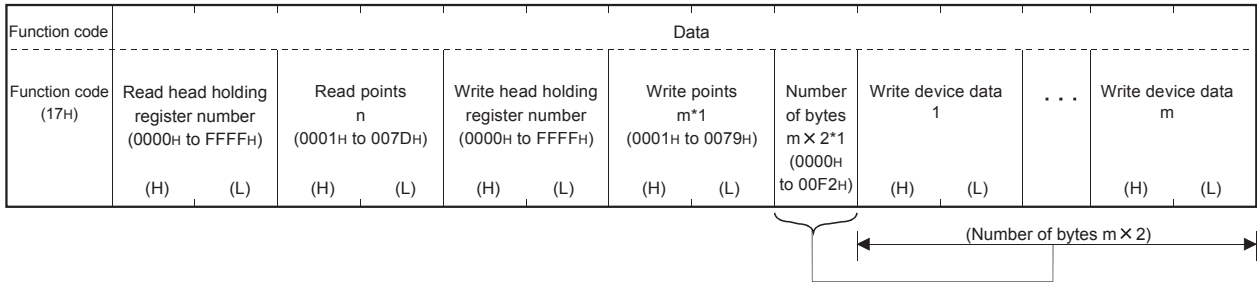

*1: The number of points specified as the write points must be matched with the number of bytes.

(2) Response message format (Slave → Master)
(When completed normally)

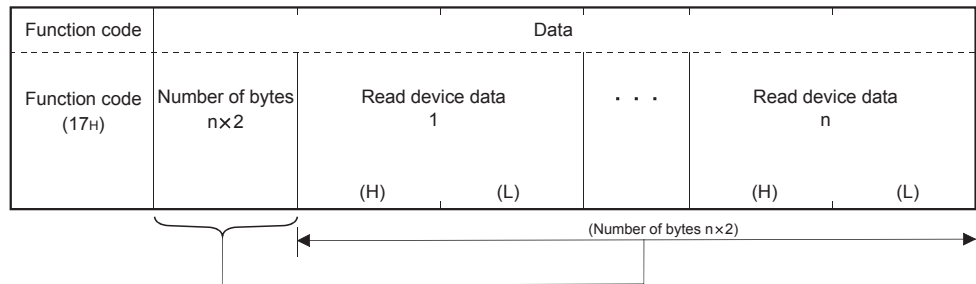

(When completed with an error)

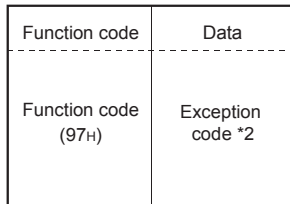

*2: When completed with an error, the exception code and error code are stored into the buffer memory.

Refer to Section 11.3 for the storage location, confirmation method and more details.

5 FUNCTIONS

This chapter explains the functions of the QJ71MT91.

5.1 Function List

The function list of the QJ71MT91 is indicated below.

Function		Description	Reference
Master function (*4)	Automatic communication	Automatically issues device read/write request messages from the master (QJ71MT91) to the MODBUS [®] /TCP-compatible slave device.	Section 5.2.1
	Dedicated instruction (*1)	Allows reading/writing of the MODBUS [®] device at any timing with a sequence program.	Chapter 10
Slave function	Automatic response function(*2)	Automatically performs the processing corresponding to the function code in the request message received from the master, and automatically sends a response message.	Section 5.3.1
	MODBUS device assignment function(*3)	Automatically converts access from the slave (QJ71MT91) to the MODBUS [®] device into access to the programmable controller CPU device. Users can assign it as desired. This enables direct access from the MODBUS [®] /TCP-compatible master device to the programmable controller CPU device memory.	Section 5.3.2
Ethernet function	KeepAlive function	Confirms the status of communication with the target device where a TCP connection has been established. When communication is not made for a given period of time between the QJ71MT91 and the open target device, the QJ71MT91 checks the target device for existence and cuts off unnecessary TCP connections.	Section 5.4
	Router relay function	Exchanges data with the device connected to other Ethernet via router(s) and/or gateway(s). (This is not a function with which the QJ71MT91 operates as a router.)	Section 5.5
	IEEE802.3 frame	Allows connection with the device that uses the IEEE802.3 frame.	Section 6.6
Redundant system function		A network can be configured in a redundant system.	(*5)
GX Developer connection function		Allows connection of up to eight GX Developers via the QJ71MT91.	Section 5.6
QJ71MT91 status check function		Checks the operations of the QJ71MT91 and send/receive functions.	—
	Hardware test	Tests the RAM and ROM of the QJ71MT91.	Section 6.5.1
	Self-loopback test	Tests the send/receive functions and hardware of the QJ71MT91.	Section 6.5.2

Function	Description	Reference
Various settings using utility package	Use of the utility package (GX Configurator-MB) allows easy parameter settings (the basic parameters and automatic communication parameters) and status monitoring.	Chapter 8

- *1: Dedicated instructions are not available when the QJ71MT91 is installed to a MELSECNET/H remote I/O station or a redundant system.
- *2: When the QJ71MT91 is mounted on a MELSECNET/H remote I/O station, there is a restriction on the function code supported by the automatic response function.
Refer to Section 4.1 for details.
- *3: When the QJ71MT91 is mounted on a MELSECNET/H remote I/O station, there is a restriction on the assignment range of the MODBUS[®] device assignment function.
Refer to Section 7.4.2 for details.
- *4: When the QJ71MT91 is mounted on the main base unit of a redundant system, the master function cannot be used.
- *5: For details of the redundant system function, refer to the QnPRHCPU User's Manual (Redundant System).

5.2 Master Function

This section explains the functions of the QJ71MT91 as a master of MODBUS[®] /TCP.

5.2.1 Automatic communication function

The automatic communication function allows device read/write request messages to be automatically issued from the QJ71MT91 to the MODBUS[®] /TCP-compatible slave devices.

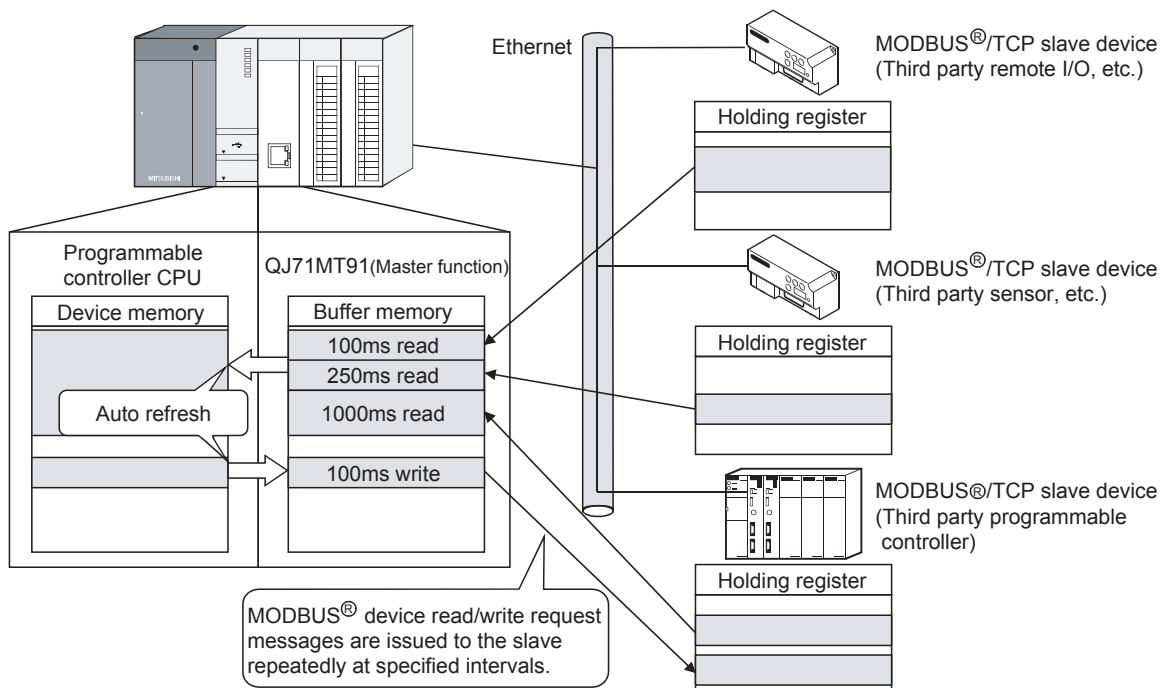

(1) To use automatic communication function

Set the automatic communication parameters to use this function.

Refer to Section 7.3 for details of the automatic communication parameters.

(2) Start and stop of automatic communication function

- (a) When the automatic communication parameters are set from the utility package (GX Configurator-MB), the automatic communication function is activated by powering ON the programmable controller from OFF or by resetting the programmable controller CPU (with the programmable controller CPU's RUN/STOP switch set to RUN).

The automatic communication will not start if the programmable controller is powered ON from OFF or if the programmable controller CPU is reset (with the programmable controller CPU's RUN/STOP switch set to STOP).

If the QJ71MT91 is mounted on a MELSECNET/H remote I/O station, the automatic communication function is activated when the remote I/O station receives the information notifying the status change (from STOP to RUN) of the remote master station's programmable controller CPU.

Setting the automatic communication parameters from GX Configurator-MB eliminates the need of a sequence program for start.

- (b) When the QJ71MT91 starts communication with the slave device with the automatic communication function, the SD and RD LEDs turn ON. (Only when communicating)
- (c) On the "Automatic communication status" screen of GX Configurator-MB, the start/stop test of the automatic communication function can be performed. (Refer to Section 8.6.3.)
- (d) To start or stop the automatic communication function from a sequence program, turn on/off Automatic communication parameter setting request/Automatic communication start request (Y4) and Automatic communication stop request (Y6).
- (e) Automatic communication start/stop timing chart

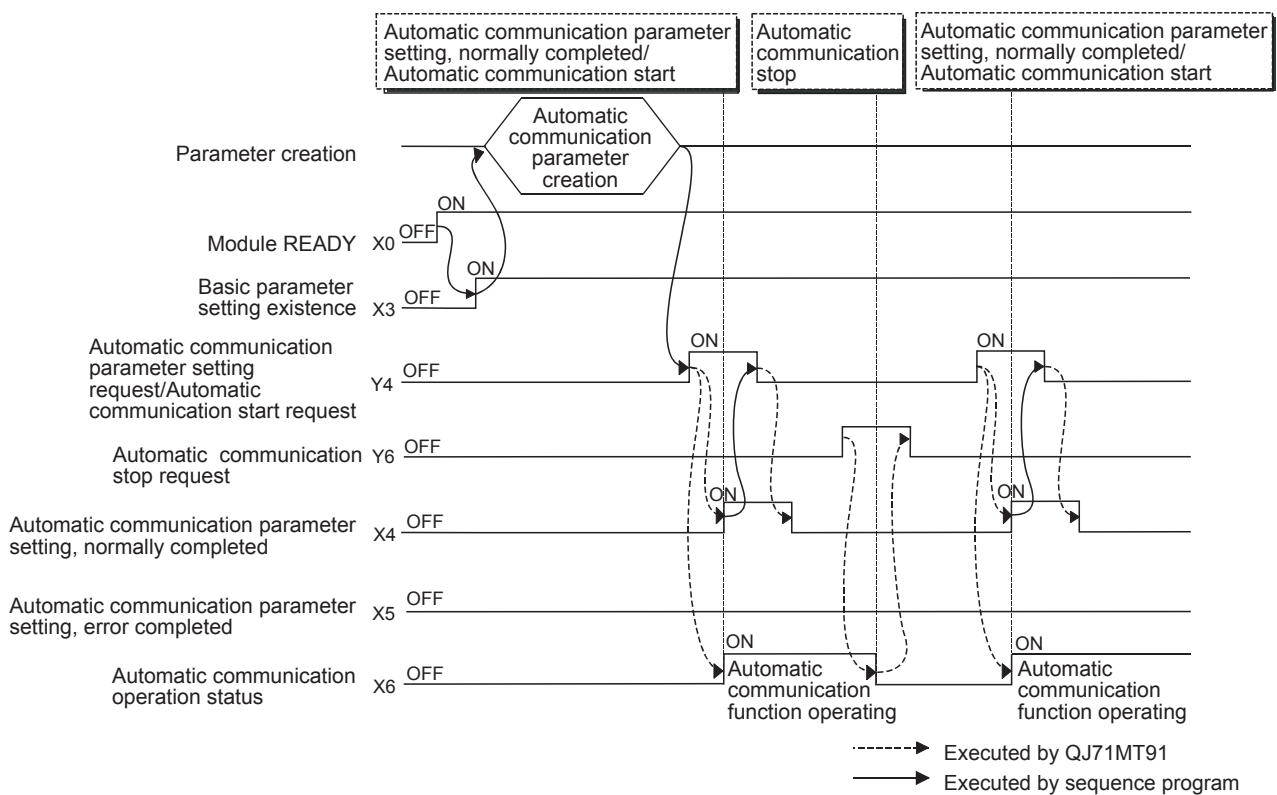

- (f) Precautions for starting/stopping the automatic communication function
 - 1) Be sure to turn on Automatic communication parameter setting request/Automatic communication start request (Y4) after Module READY (X0) and Basic parameter setting existence (X3) have turned on.
 - 2) When using Automatic communication stop request (Y6) to stop the automatic communication function, satisfy all of the following conditions.
 - Condition 1: Module READY (X0) is on.
 - Condition 2: Basic parameter setting existence (X3) is on.
 - Condition 3: Automatic communication operation status (X6) is on.
 - 3) An error will occur if Automatic communication stop request (Y6) is executed when the automatic communication function has stopped (Automatic communication operation status (X6) is off).

- 4) Even if no response is sent from the communication target slave, the automatic communication function does not stop until Automatic communication stop request (Y6) turns on.
- 5) When the automatic communication function stops, the TCP connections used by the automatic communication function are all disconnected.
- 6) When the automatic communication parameters are set on GX Configurator-MB
When the automatic communication parameters are set on GX Configurator-MB, the automatic communication function will be automatically started at the timing shown in (2) (a) of this section. When the automatic communication function is active, and when the target slave device is not in normal condition (disconnected, down, not ready for communication, etc.), perform either of the following:
 - After the target slave device is recovered, set automatic communication parameters on the sequence program and start the automatic communication function.
 - Ignore the error (Exception message reception (error code: 7360H) or Response monitoring timer time-out error (error code: 7378H), etc.)

(3) Automatic communication operation status

- (a) Confirming automatic communication operation status
Use Automatic communication operation status (X6) to confirm the automatic communication operation status.
- (b) When an error occurs in the automatic communication, Automatic communication error status (X7) turns ON.
Also, any erroneous part of the parameters and error details can be identified by the following:
 - 1) Acquisition of automatic communication parameter number during error occurrence
Acquisition of the automatic communication parameter number for the error Check the operation status storage area (0C20H to 0C23H) in the buffer memory to identify the error. (Refer to Section 11.3.1)
 - 2) Error code confirmation
In the automatic communication error code storage area (0C28H to 0C67H) of the buffer memory, check the error code stored in the area corresponding to the automatic communication parameter number identified in the above 1). (Refer to Section 11.3.1 (7))
Refer to Section 11.3.3 for the error code.

POINT
(1) On the "Automatic communication status" screen of GX Configurator-MB, the operation status and error code for each automatic communication parameter can be confirmed. (Refer to Section 8.6.3)
(2) The QJ71MT91 guarantees the data between the programmable controller devices and the network line in units of one word (16 bits).

(c) Automatic communication operation flowchart

Using the set automatic communication parameters, the automatic communication function operates according to the repeat interval timer and response monitoring timer settings as shown below.

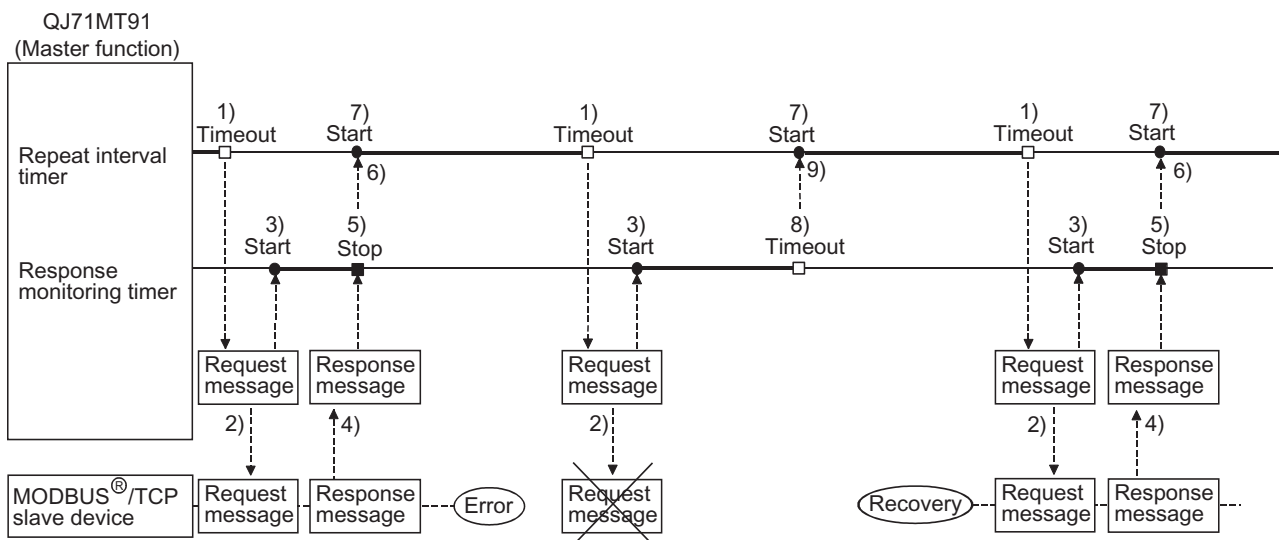
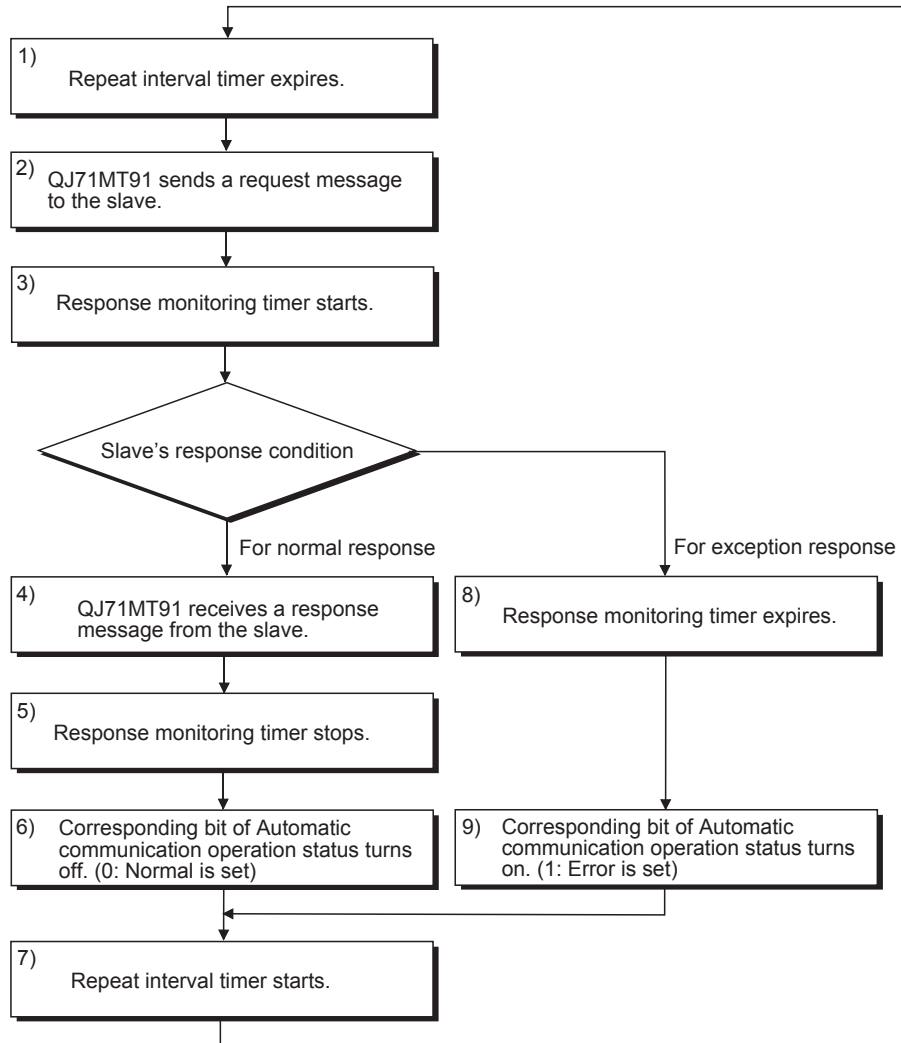

(4) Automatic communication function buffer areas

(a) Automatic communication function buffer areas

The automatic communication function uses the following buffer memory areas.

Name	Application	Buffer Memory Address
Automatic communication function buffer input area	Stores data read from the slave	1000 _H to 1FFF _H
Automatic communication function buffer output area	Stores data to be written to the slave	3000 _H to 3FFF _H

(b) Transfer direction of automatic communication function buffer input/output area

The following shows the transfer directions of data stored into the buffer memory by the automatic communication function.

1) Transfer direction in automatic communication function buffer input area

When receiving a response message from the slave, the QJ71MT91 writes data to the automatic communication function buffer input area in descending order of the addresses in 1 word (16 bits) unit.

2) Transfer direction in automatic communication function buffer output area

When sending a request message to the slave, the QJ71MT91 creates it by reading data from the automatic communication function buffer output area in descending order of the addresses in 1 word (16 bits) unit.

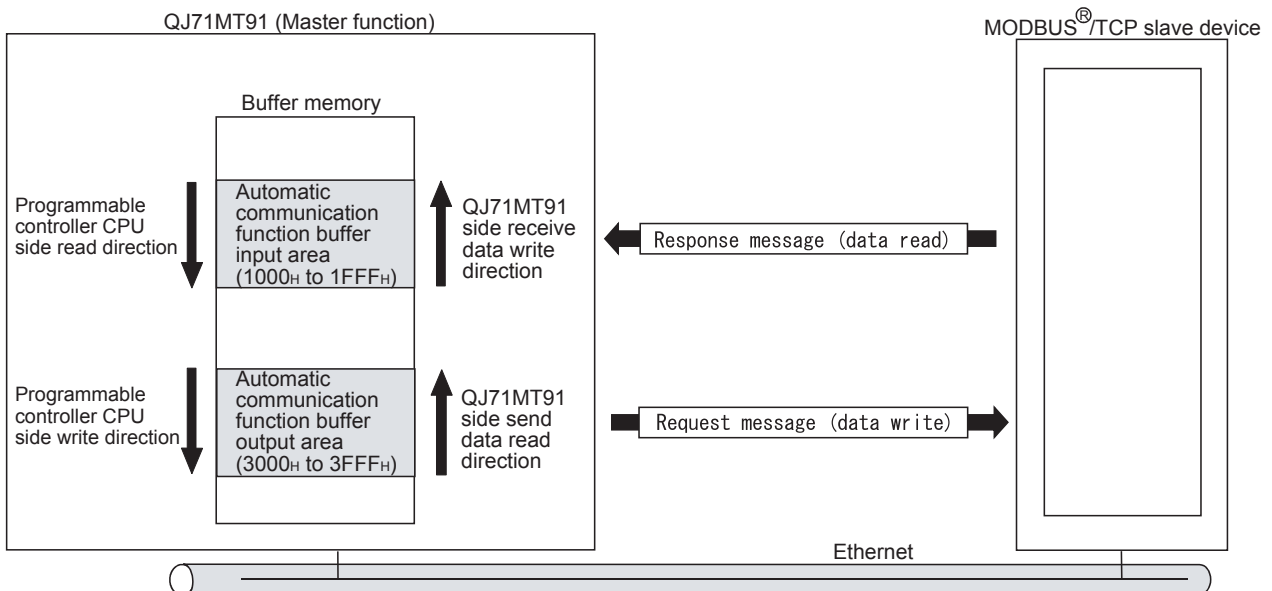

(c) Data transfer between automatic communication function buffer areas and programmable controller CPU device memory

Data can be transferred between the automatic communication buffer area and programmable controller CPU device memory by either of the following methods.

Transfer Method	Transfer by auto refresh setting
Transfer by auto refresh setting	Make the auto refresh setting with GX Configurator-MB. (Refer to Section 8.5.)
Transfer using the sequence program	Specify the intelligent function module device (Un\G□) * in a sequence program to make transfer.

*: For details of the intelligent function module device, refer to the QCPU User's Manual (Function Explanation, Program Fundamentals).

5.2.2 Dedicated instructions

Used in a sequence program to read/write the MODBUS® device data, etc. at any timing.

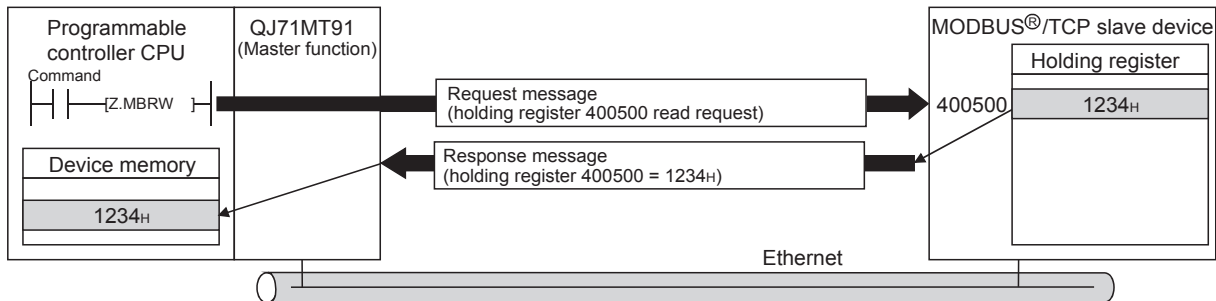

Dedicated instruction list

The list of the dedicated instructions supported by the QJ71MT91 is indicated below.

Dedicated Instruction	Description	Reference
MBRW	Issues a MODBUS® device read/write request message to the slave.	Section 10.2
MBREQ	Communicates with the slave in the request message format of any PDU (protocol data unit).	Section 10.3

5.3 Slave Function

This section explains the functions of the QJ71MT91 as a slave of MODBUS[®] /TCP.

5.3.1 Automatic response function

The automatic response function allows the QJ71MT91 (slave function) to automatically execute the processing requested by the function code of a request message from the master and return a response message to the master. The automatic response function uses the MODBUS[®] device assignment function. Refer to Section 5.3.2 for the MODBUS[®] device assignment function. Refer to Section 4.1 for the function codes supported by the slave function of the QJ71MT91.

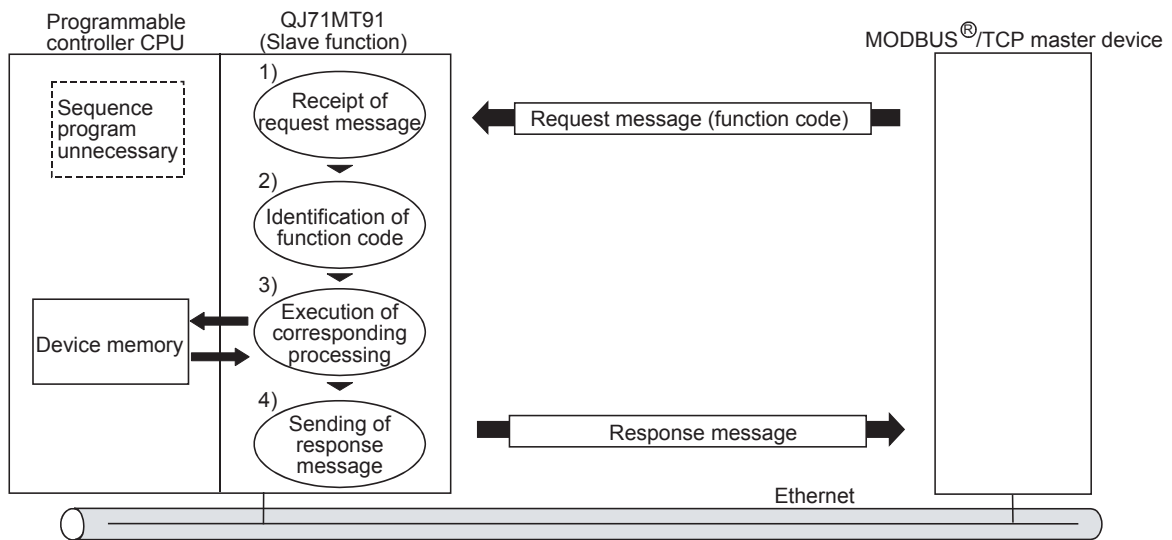

5.3.2 MODBUS[®] device assignment function

(1) MODBUS[®] device assignment function

- (a) The MODBUS[®] device assignment function automatically converts access to a slave (QJ71MT91) MODBUS[®] device into access to a programmable controller CPU device.
- (b) Using MODBUS[®] device assignment parameters, the MODBUS[®] devices are correlated with the programmable controller CPU device memory. This allows direct access from the MODBUS[®] /TCP-compatible master device to the programmable controller CPU device memory.
- (c) Since the QJ71MT91 supports large capacities of MODBUS[®] devices, all the device memories of the programmable controller CPU can be assigned. Refer to Section 7.4.1 for the MODBUS[®] device sizes.

(2) MODBUS[®] device assignment parameter setting

- (a) Set the MODBUS[®] device assignment parameters from the utility package (GX Configurator-MB).
(Setting from a sequence program is also available. (Refer to Section 9.1.3.))
Refer to Section 7.4 for details of the MODBUS[®] device assignment parameters.
- (b) As the MODBUS[®] device assignment parameters, the default assignment parameters are available.
Refer to Section 7.4.3 for the default assignment parameters.

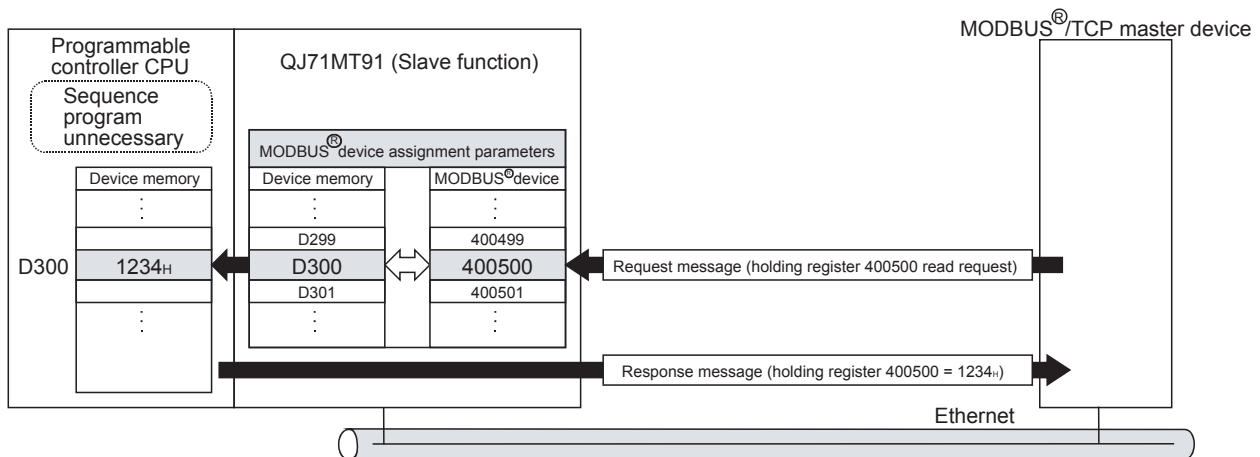

5.4 KeepAlive Function

(1) KeepAlive function

When communication with the target device whose TCP connection is open is not made for a predetermined period of time, a KeepAlive ACK message is sent from the QJ71MT91 to the target device. The alive status of the target device can be checked by whether a response message is returned or not to that ACK message. (*1)

*1: The connection may be disconnected if the target device does not support the TCP KeepAlive function (unable to respond to the KeepAlive ACK message).

(2) To use KeepAlive function

To use the KeepAlive function, set the KeepAlive of the basic parameter to "Used". (Default: Used)

The following basic parameters are available for the KeepAlive function.

- KeepAlive start timer value
- KeepAlive interval timer value
- KeepAlive resend count

Change the default values set to the basic parameters as necessary.

Refer to Section 7.2 for details of the basic parameters.

(3) Operation of KeepAlive function

- (a) The QJ71MT91 starts the KeepAlive start timer when it receives the last message from the target device whose TCP connection is open.
- (b) The QJ71MT91 sends the KeepAlive message for alive check to the target device and starts the KeepAlive interval timer when the KeepAlive start timer expires.
- (c) The QJ71MT91 resends the KeepAlive message for alive check to the target device when ACK is not returned from the target device and the KeepAlive interval timer expires.
The QJ71MT91 sends the KeepAlive message for alive check by the number of times set as the KeepAlive resend count until it receives ACK from the target device.
- (d) An alive check error occurs if the QJ71MT91 cannot receive ACK from the target device after it has sent the KeepAlive message for alive check by the number of times set as the KeepAlive resend count.
At that time, the QJ71MT91 forcibly closes the TCP connection and issues an error code.

<Operation of KeepAlive function>

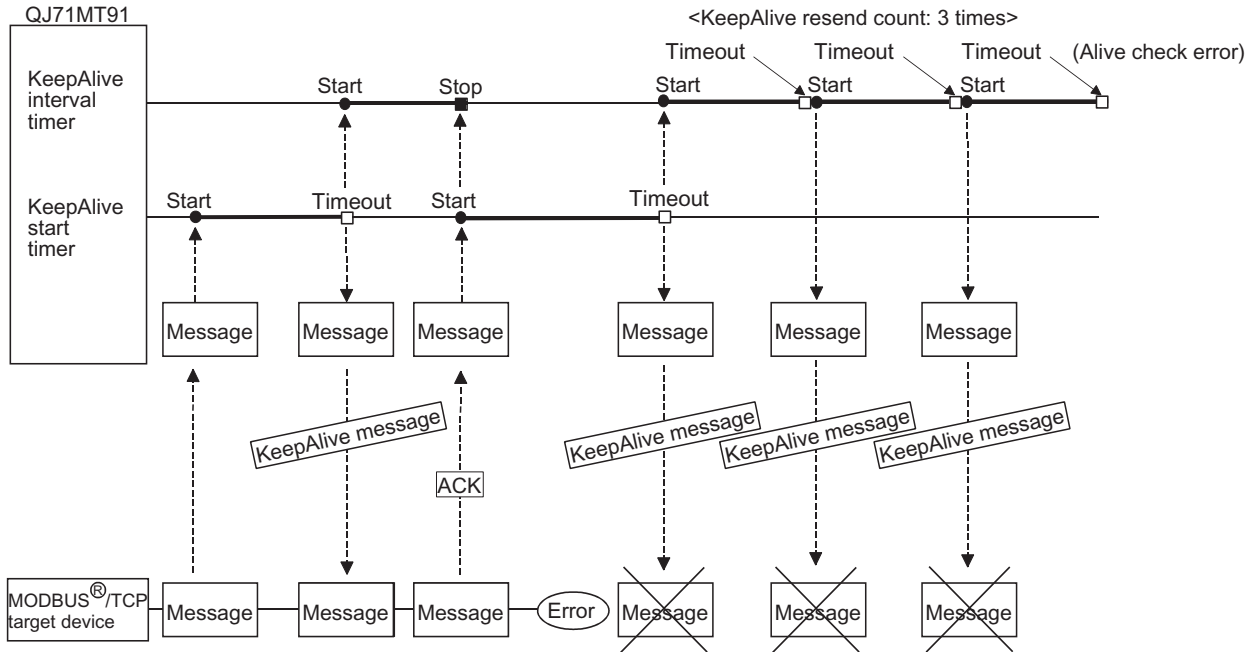

5.5 Router Relay Function

(1) Router relay function

The router relay function enables data communications with slave devices connected to other Ethernets via routers and gateways.

(2) To use router relay function

To use the router relay function, set the router relay function of the basic parameter to "Used". (Default: Not used)

The following basic parameters are available for the router relay function.

- Subnet mask pattern
- Default router IP address
- Number of routers set
- Router information

Change the default values set to the basic parameters as necessary.

Refer to Section 7.2 for details of the routing information.

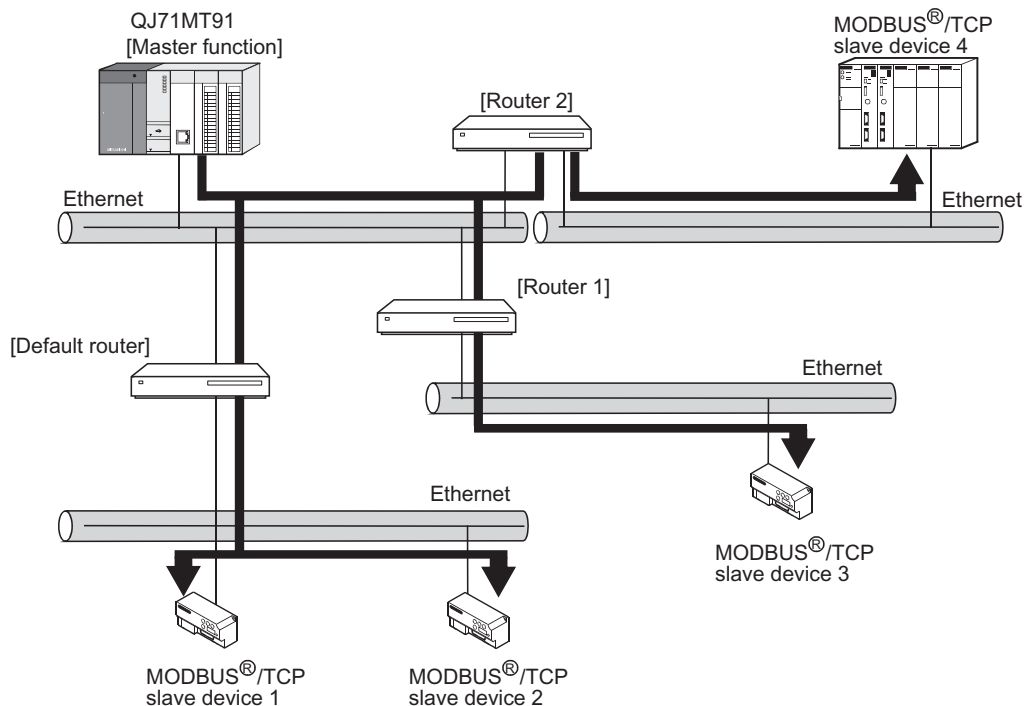
**POINT**

- (1) When the slave function of the QJ71MT91 is used to communicate with the master device on another Ethernet, communication can be made without use of the router relay function.
- (2) A system using a Proxy router need not use the router relay function.
- (3) The router relay function is not the function that operates the QJ71MT91 as a router.

5.6 GX Developer Connection Function

(1) GX Developer connection function

- (a) The GX Developer connection function allows connection to GX Developer via the QJ71MT91.
- (b) The QJ71MT91 can connect a maximum of eight GX Developer.
- (c) Refer to Section 7.2.3 for the GX Developer connection setting.

(2) Accessible range

Refer to Section 2.3 for details of the accessible range.

(3) GX Developer connection setup

Refer to Appendix 3 for the method of GX Developer connection setup.

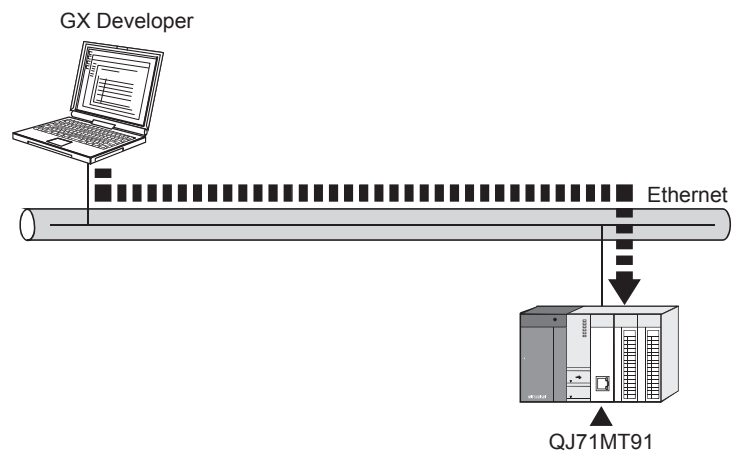

6 PRE-OPERATIONAL PROCEDURES AND SETTING

This chapter explains the procedures and setting method for operating the QJ71MT91 in a system.

POINT
(1) For use of the QJ71MT91, read the safety precautions provided in the first pages of this manual.
(2) The mounting and installation environment of the QJ71MT91 are the same as those of the programmable controller CPU. For details, refer to the QCPU User's Manual (Hardware Design, Maintenance and Inspection).

6.1 Handling Precautions

This section explains the precautions for handling the QJ71MT91.

- (1) Since the case of the QJ71MT91 is made of resin, do not drop or give it hard impact.
- (2) Always make sure to touch the grounded metal to discharge the electricity charged in the body, etc., before touching the module.
Failure to do so may cause a failure or malfunctions of the module.
- (3) Tighten the screws such as module fixing screws within the following ranges.

Screw Location	Tightening Torque Range
Module fixing screw (normally not required) (M3 screw) *1	0.36 to 0.48N · m

*1: The module can be easily fixed onto the base unit using the hook at the top of the module. However, it is recommended to secure the module with the module fixing screw if the module is subject to significant vibration.

6.2 Pre-Operational Procedures and Setting

A rough procedure for operation is shown below.

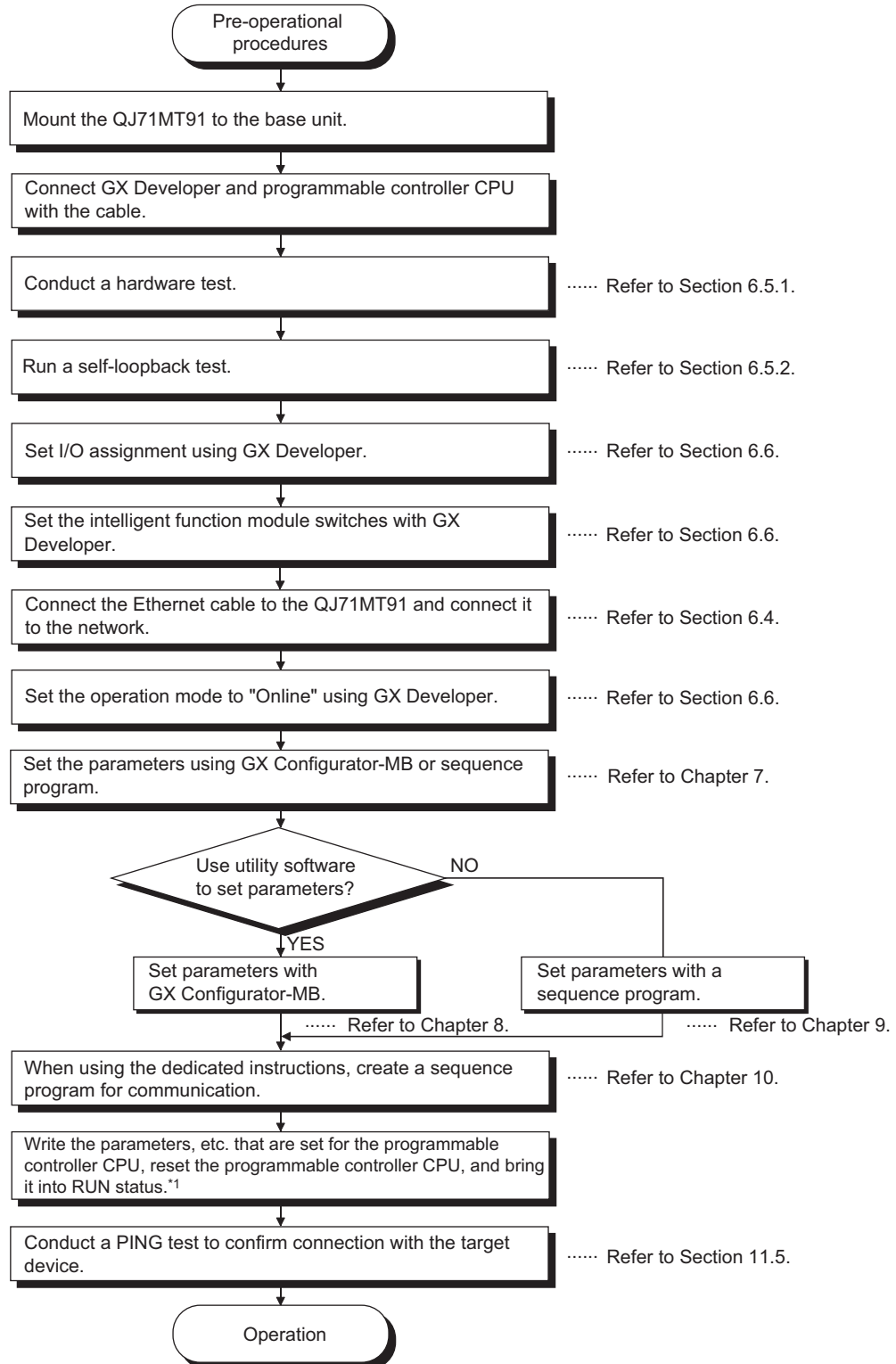

*1: If parameters are set at the GX Configurator-MB, power OFF and then ON or reset the programmable controller CPU with the CPU RUN/STOP switch set at RUN.

IMPORTANT

- (1) When setting parameters, do not write any data to the "System area (use prohibited)" among the QJ71MT91 buffer memory addresses.
Doing so may cause malfunction of the programmable controller system.
- (2) When making any parameter setting request, etc., do not output (turn ON) the "Use prohibited" signal among the output signals.
Doing so may cause malfunction of the programmable controller system.
- (3) When having replaced the QJ71MT91, reset the other device of communication target.
If the device holds the Ethernet address of the communication target, communication may not be continued since the Ethernet address is changed by the replacement of the QJ71MT91.
Similarly, after replacing the target device (personal computer, etc.), redo the QJ71MT91 basic parameter setting or restart the QJ71MT91.

POINT

- (1) Use GX Developer to make I/O assignment and intelligent function module switch setting.
Use GX Configurator-MB or sequence programs to set the basic parameters (refer to Section 7.2), automatic communication parameters (refer to Section 7.3), etc. of the QJ71MT91.
- (2) To update the parameter settings added/changed on GX Developer, write the parameters to the programmable controller CPU, and then reset the programmable controller CPU.

6.3 Part Names

This section indicates the names of the QJ71MT91 parts.

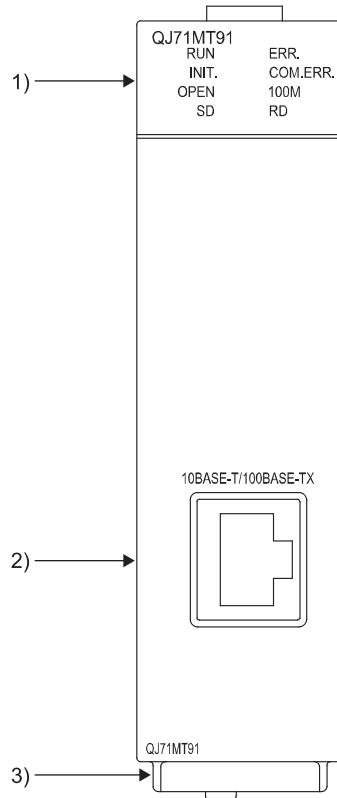

	Name	Description
1)	Indicator LEDs	Refer to the following section, (1) Indications of indicator LEDs.
2)	10BASE/T/100BASE-TX connector (RJ45) * 1	Connector for connection of the QJ71MT91 to 10BASE-T/100BASE-TX. (The QJ71MT91 detects whether 10BASE-T or 100BASE-TX is used according to the hub.)
3)	Serial number plate	Displays the serial number printed on the rating plate.

* 1: The LED on the connector is not lit.

Depending on the serial number, the connector orientation is left-right reversal.

(1) Indications of indicator LEDs *1

QJ71MT91	
RUN	<input type="checkbox"/> <input type="checkbox"/> ERR.
INIT.	<input type="checkbox"/> <input type="checkbox"/> COM.ERR.
OPEN	<input type="checkbox"/> <input type="checkbox"/> 100M
SD	<input type="checkbox"/> <input type="checkbox"/> RD

LED Name	Indication	ON	OFF
RUN	Operation status	Normal	Error
INIT.	Initial processing status	Normal completion of basic parameter setting	Basic parameter setting in progress or nonexistent
OPEN	TCP connection open status	Presence of open TCP connection	Absence of open TCP connection
SD	Send status	Data send in progress	Data not yet sent
ERR.	Setting error status	Error	Normal setting
COM.ERR.	Communication error status	Communication error occurrence *2	Normal communication in progress
100M	Transmission speed	100Mbps	10Mbps or not connected
RD	Receive status	Data receive in progress	Data not yet received

*1: For troubleshooting, refer to Section 11.1.

*2: When the COM. ERR. LED has turned off, refer to Section 11.4.

6.4 Connection to Ethernet

This section explains how to connect the QJ71MT91 to the 100BASE-TX or 10BASE-T network.

(1) Connection precautions

The following are the precautions for connection of the QJ71MT91.
Handle the QJ71MT91 correctly, paying full attention to safety.

CAUTION

- Sufficient safety measures must be taken for 100BASE-TX or 10BASE-T installation work.
Consult a specialist when connecting cable terminals or installing trunk line cables, etc.
- Use the connection cable, which complies with the corresponding standard given in Section 3.1.
- Do not install the control and communication cables together with the main circuit and power cables, etc.
Keep a distance of at least 100mm between them.
Failure to do so can cause a malfunction due to noise.
- The communication and power cables connected to the module must be placed in a duct or secured with clamps.
If the cables are not secured, inadvertent tripping can cause damage to the module or cables or a malfunction.
- When disconnecting any of the communication and power cables connected to the module, do not pull it by holding the cable part.
Disconnect the cable by holding the connector connected to the module.
Failure to do so can cause a malfunction or damage to the module or cable.

(2) Connection to 10BASE-T/100BASE-TX

This section explains how to connect the QJ71MT91 to the 10BASE-T/100BASE-TX network.

A twisted pair cable connection diagram is shown below.

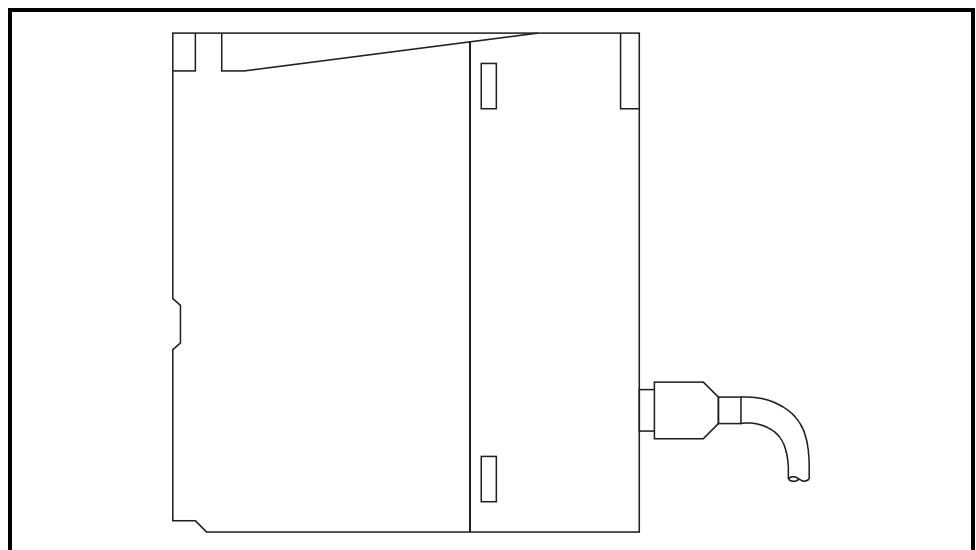

<Operation procedures>

(Step 1) Connect the twisted pair cable to the hub.

(Step 2) Connect the twisted pair cable to the QJ71MT91.

POINT
(1) The QJ71MT91 detects whether 10BASE-T or 100BASE-TX, and the full or half duplex communication mode is used according to the hub. For connection with the hub that does not support the auto negotiation function, set the half duplex communication mode on the hub side.
(2) Refer to Section 2.2 for the devices necessary for connection to 10BASE-T/100BASE-TX and a system configuration example.

6.5 Unit Tests

This section explains the unit tests conducted to check the send/receive functions and hardware of the QJ71MT91.

The unit tests can be run by changing the intelligent function module switch setting of the QJ71MT91 (Refer to Section 6.6).

6.5.1 Hardware test

The RAM and ROM of the QJ71MT91 are tested in the following steps.

The test result can be checked with the LEDs on the front of the QJ71MT91.

Step	Operation	LED Status		
		[RUN]	[OPEN]	[ERR.]
1	STOP the programmable controller CPU. Disconnect the network cable from the QJ71MT91.	—	—	—
2	In the intelligent function module switch setting of GX Developer, set Switch 1 to 000D _H to select the hardware test mode. (Refer to Section 6.6.)	—	—	—
3	Reset the programmable controller CPU. (Test start)	●	●	○
4	After 5 seconds, check the status of each LED.	Normal	●	○
		Error *	●	○
5	When the hardware test is completed, change the operation mode to "Online" or another mode in the intelligent function module switch setting.	—	—	—
6	Reset the programmable controller CPU.	—	—	—

●: ON ○: OFF

*: A possible cause of error is the RAM/ROM fault of the QJ71MT91.

When an error occurs, the error code is stored into the error log area (address: CFE_H to DFF_H) of the buffer memory in the QJ71MT91.

Using GX Developer, confirm the error code and take corrective action.

(Refer to Section 11.2 and 11.3.)

POINT

When the hardware test results in an error, check the mounting status of the module and run the test again.

If the error occurs again, its possible cause is the hardware fault of the QJ71MT91.

Please consult your local Mitsubishi representative.

6.5.2 Self-loopback test

This section explains the self-loopback test conducted to check the QJ71MT91 hardware including the send/receive circuits.

The procedure for the self-loopback test is shown below.

This test is run for about 5 seconds.

The test result can be checked with the LEDs on the front of the QJ71MT91.

Step	Operation	LED Status		
		[RUN]	[OPEN]	[ERR.]
1	STOP the programmable controller CPU. Disconnect the network cable from the QJ71MT91.	—	—	—
2	In the intelligent function module switch setting of GX Developer, set Switch 1 to 000E _H to select the self-loopback test mode. (Refer to Section 6.6.)	—	—	—
3	Reset the programmable controller CPU. (Test start)	●	●	○
4	After 5 seconds, check the status of each LED.	Normal	●	○
		Error *	●	○
5	When the self-loopback test is completed, change the operation mode to "Online" or another mode in the intelligent function module switch setting.	—	—	—
6	Reset the programmable controller CPU.	—	—	—

●: ON ○: OFF

*: A possible cause of error is the hardware fault of the QJ71MT91.

When an error occurs, the error code is stored into the error log area (address: CFE_H to CFF_H) of the buffer memory in the QJ71MT91.

Using GX Developer, confirm the error code and take corrective action.

(Refer to Section 11.2 and 11.3.)

POINT

When the self-loopback test results in an error, run the test again.

If the error occurs again, its possible cause is the hardware fault of the QJ71MT91.

Please consult your local Mitsubishi representative.

6.6 Intelligent Function Module Switch Setting

[Setting purpose]

Set the operation mode, communication condition and IP address.

[Starting procedure for intelligent function module switch setting screen]

1. Start GX Developer.
2. Double-click "Parameter" in the project window of GX Developer, and double-click "PLC parameter".
3. Click the <<I/O assignment>> tab and click the [Switch setting] button.
The "Switch setting for I/O and intelligent function module" screen is displayed.

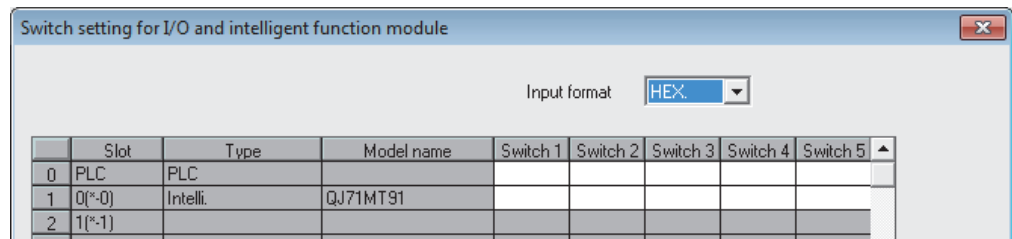

[Operation procedure]

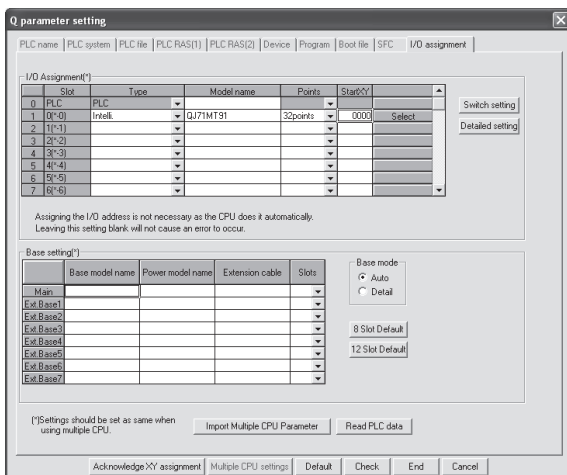

1. I/O assignment setting screen

Set the following to the slot where the QJ71MT91 is mounted.

- Type : Select "Intelli".
- Model name : Enter the model name of the module.
- Points : Select 32 points.
- Start-XY : Enter the head I/O number of the QJ71MT91.
- Detailed setting : Specify the control CPU of the QJ71MT91 in a multiple CPU system.

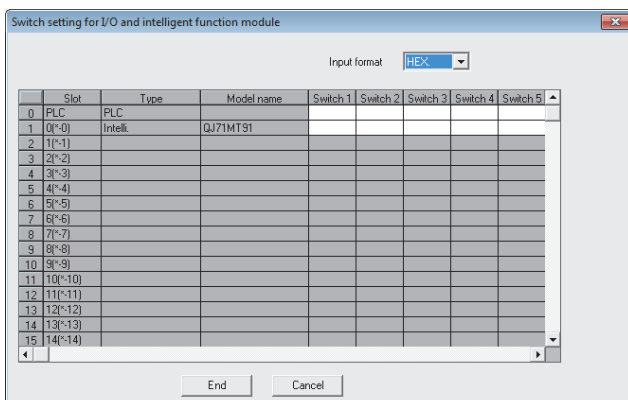

2. Intelligent function module switch setting screen
- Click the [Switch setting] button on the I/O assignment setting screen to display the screen shown on the left.

Referring to (1) to (4) in this section, make switch setting.
Entering the values in hexadecimal makes the setting easy. Change the input format into HEX before entering the values.

3. After setting, write the data to the programmable controller, and power the programmable controller OFF, then ON or reset the programmable controller CPU.

[Intelligent function module switch setting items]

Switch No.	Description	Initial Value	Reference
Switch 1	Operation mode setting	0000H	(1) in this section
Switch 2	Communication condition setting	0000H	(2) in this section
Switch 3	IP address setting (high order)	C001H	(3) in this section
Switch 4	IP address setting (low order)	00FEH	
Switch 5	Redundant settings	0400H	(4) in this section

POINT

- (1) The settings made with the intelligent function module switches become effective after power is switched OFF, then ON or the programmable controller CPU is reset.
Setting change during operation is also not available.
- (2) When the intelligent function module switch setting has not been made, the initial values of each switch are used for operation.

REMARK

For the operation method of GX Developer, refer to the GX Developer Operating Manual.

(1) Operation mode setting (Switch 1)

Set the operation mode of the QJ71MT91, such as the online or offline mode.

Set value *	Item	Description
0000H	Online	Normal operation mode. Communicates with the target device.
0001H	Offline	Disconnects the local station from the network. In the offline mode, parameter setting cannot be executed. Communication with the other station is not available, either.
000DH	Hardware test	Tests the RAM and ROM of the QJ71MT91. (Refer to Section 6.5.1)
000EH	Self-loopback test	Checks the hardware including the send/receive circuits of the QJ71MT91. (Refer to Section 6.5.2.)

*: A switch 1 error (error code: 7301H) will occur if the set value is other than the value indicated in the table.

If the switch error has occurred, correct the switch setting and then switch the power OFF and ON or reset the programmable controller CPU.

(2) Communication condition setting (Switch 2)

Specify the starting methods, the send frame, and the online change enable/disable setting.

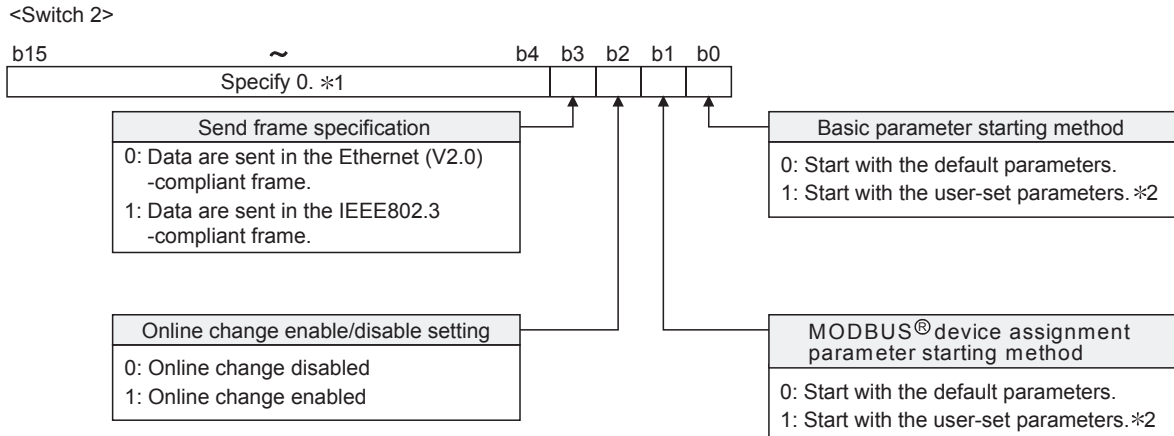

*1 : The information in this area is ignored.

However, if the setting in this area is other than 0, a switch 2 error (error code: 7302_H) occurs. If the switch error has occurred, correct the switch setting and then switch the power OFF then ON or reset the programmable controller CPU.

*2 When setting parameters by GX Configurator-MB, set 1 to both b0 and b1.

(a) Basic parameter starting method (Bit 0)

Set the basic parameters for the time when the power is turned ON from OFF.

[When corresponding bit is OFF]

The QJ71MT91 starts up with its default basic parameters, and starts communication.

[When corresponding bit is ON]

The QJ71MT91 starts up with the basic parameters set using a sequence program or GX Configurator-MB, and starts communication.

However, the user-set basic parameters are not registered to the QJ71MT91 until the following operation is performed.

- When a sequence program was used to set the basic parameters
Turn ON "Basic parameter setting request (Y1)".
- When GX Configurator-MB was used to set the basic parameters
After the intelligent function module parameters have been written to the programmable controller CPU, the initial setting is updated when the programmable controller is powered ON from OFF or the programmable controller CPU is reset (with the programmable controller CPU's RUN/STOP switch set to RUN).

POINT

- (1) Make this setting ON when a sequence program or GX Configurator-MB is used to set the basic parameters.
- (2) If no basic parameters have been set with this setting ON, the master function, slave function and GX Developer connection function do not operate. Refer to Section 6.6.1 for details of the communication starting conditions of this switch setting and each function.

(b) MODBUS® device assignment parameter starting method (Bit 1)

Set the MODBUS® device assignment parameters for the time when the power is turned OFF and then ON.

[When corresponding bit is OFF]

The QJ71MT91 starts up with its default MODBUS® device assignment parameters.

[When corresponding bit is ON]

The QJ71MT91 starts up with the MODBUS® device assignment parameters set using a sequence program or GX Configurator-MB. However, the user-set MODBUS® device assignment parameters are not registered to the QJ71MT91 until the following operation is performed.

- When a sequence program was used to set the MODBUS® device assignment parameters

Turn ON "MODBUS® device assignment parameter setting request (Y8)".

- When GX Configurator-MB was used to set the MODBUS® device assignment parameters

After the intelligent function module parameters have been written to the programmable controller CPU, the initial setting is updated when the programmable controller is powered ON from OFF or the programmable controller CPU is reset (with the programmable controller CPU's RUN/STOP switch set to RUN).

POINT
<p>(1) Make this setting ON when a sequence program or GX Configurator-MB is used to set the MODBUS® device assignment parameters.</p> <p>(2) If no MODBUS® device assignment parameters have been set with this setting ON, the slave function does not operate.</p> <p>Refer to Section 6.6.1 for details of the communication starting conditions of this switch setting and each function.</p>

(c) Online change enable/disable setting (Bit 2)

Set whether to enable or disable the slave (QJ71MT91) to write data to the programmable controller CPU while the programmable controller CPU is in RUN status.

[When corresponding bit is OFF]

Data write is disabled while the programmable controller CPU is in RUN status.

When the slave (QJ71MT91) receives a write request message from the master in this setting, the slave (QJ71MT91) issues the exception code (04H).

[When corresponding bit is ON]

Data write is enabled while the programmable controller CPU is in RUN status.

(d) Send frame specification (Bit 3)

Specify the frame format in which the QJ71MT91 will send data to the target device.

[When corresponding bit is OFF]

Data are sent in the Ethernet (V2.0)-compliant frame.

[When corresponding bit is ON]

Data are sent in the IEEE802.3-compliant frame.

(3) IP address setting (Switch 3, Switch 4)

Set the IP address of the QJ71MT91 on the local station.

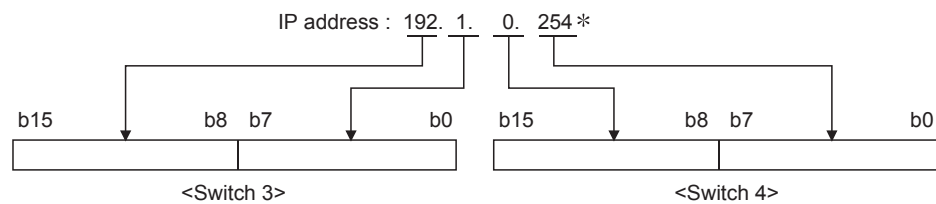

*: Set the value that satisfies the following conditions.

- Condition 1: The IP address class is any of A, B and C.
- Condition 2: All the host address bits are not "0" or "1".

If the conditions are not satisfied, a switch 3, 4 error (7303H) will occur.

In such a case, correct the switch setting and then switch the power OFF then ON or reset the programmable controller CPU.

(a) When the QJ71MT91 is mounted on a redundant system

When the QJ71MT91 is mounted on the main base unit of a redundant system, the IP addresses are assigned as follows.

System A, control system: IP address set

System B, standby system: The fourth octet of IP address set + 1

(Example) When 192.168.0.1 is set

System A, control system: 192.168.0.1

System B, standby system: 192.168.0.2

Also, the IP address assignment at a system switching differs depending on the IP mode type set using the switch 5.

[For fixed IP mode]

Fixed IP addresses are assigned to system A and system B. Even if a system switching occurs, the IP addresses are not switched.

[For redundant IP mode]

IP addresses are assigned to the control system and standby system. If a system switching occurs, the IP addresses are also switched.

REMARK

When a value of 254 is set to the fourth octet of IP address of system A or control system, the fourth octet of IP address of system B or standby system will be 253.

(4) Redundant settings (Switch 5)

When the redundant system is used, set the conditions of a system switching.

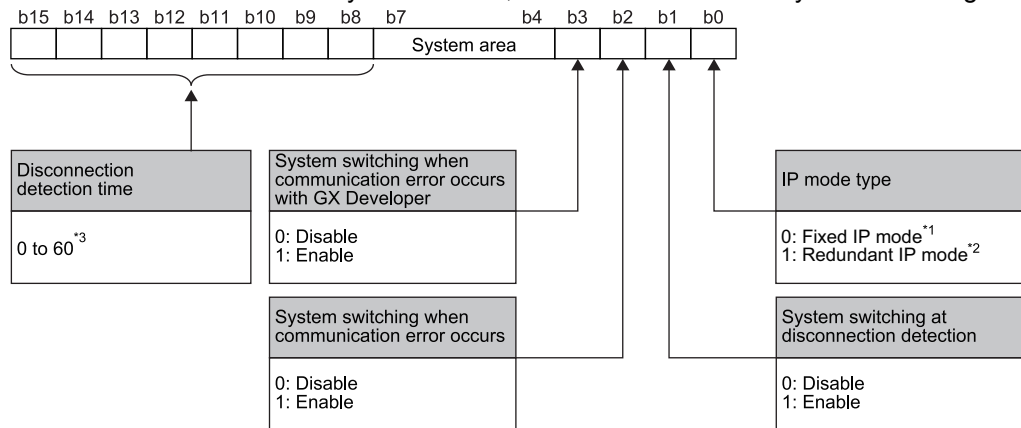

*1: A mode for which IP addresses are fixed to system A and system B.

*2: A mode for which IP addresses are switched according to a system switching of the control system and standby system.

*3: The value (0s to 30s) obtained by multiplying the setting value (0 to 60) by 500ms will be a timeout occurrence time at disconnection detection. If a value of 61 or more is set, the switch 5 error (7305H) will occur.

6.6.1 Communication starting conditions depending on basic parameter/MODBUS® device assignment parameter starting method setting

The communication starting conditions change depending on the combination of the basic parameter and MODBUS® device assignment parameter starting methods in Switch 2 of the intelligent function module switch setting.

(1) When GX Configurator-MB is used for parameter setting

When GX Configurator-MB is used to make parameter setting, set the basic parameter and MODBUS® device assignment parameter starting methods to ON.

[Intelligent function module switch setting]

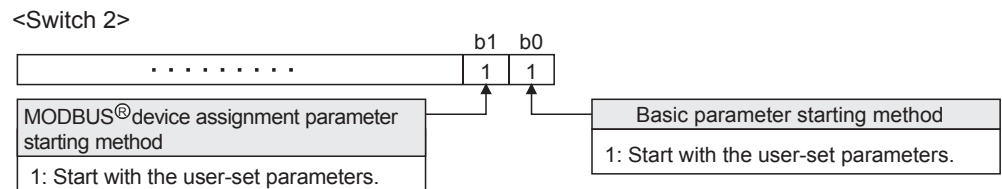

[Communication starting conditions]

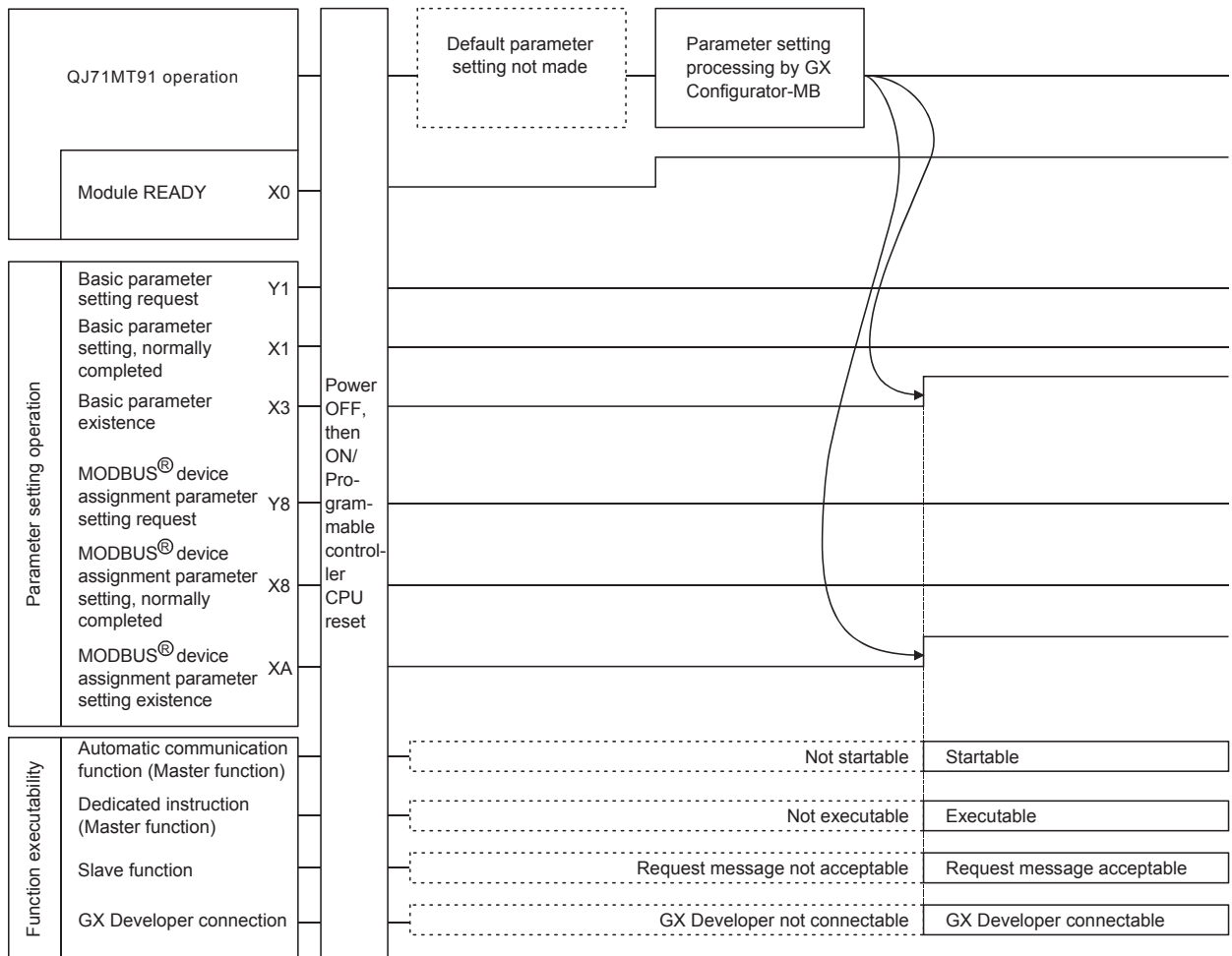

- (2) When sequence program is used for parameter setting
 - (a) When the basic parameter starting method is OFF (start with the default parameters) and the MODBUS[®] device assignment parameter starting method is OFF (start with the default parameters)

[Intelligent function module switch setting]

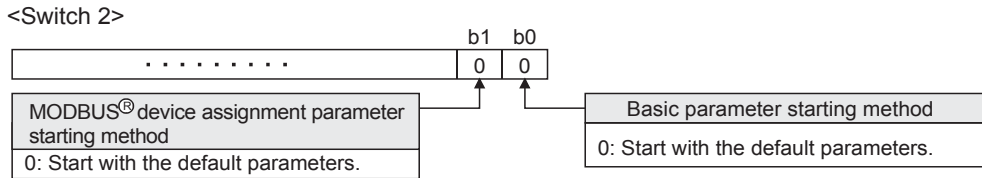

[Communication starting conditions]

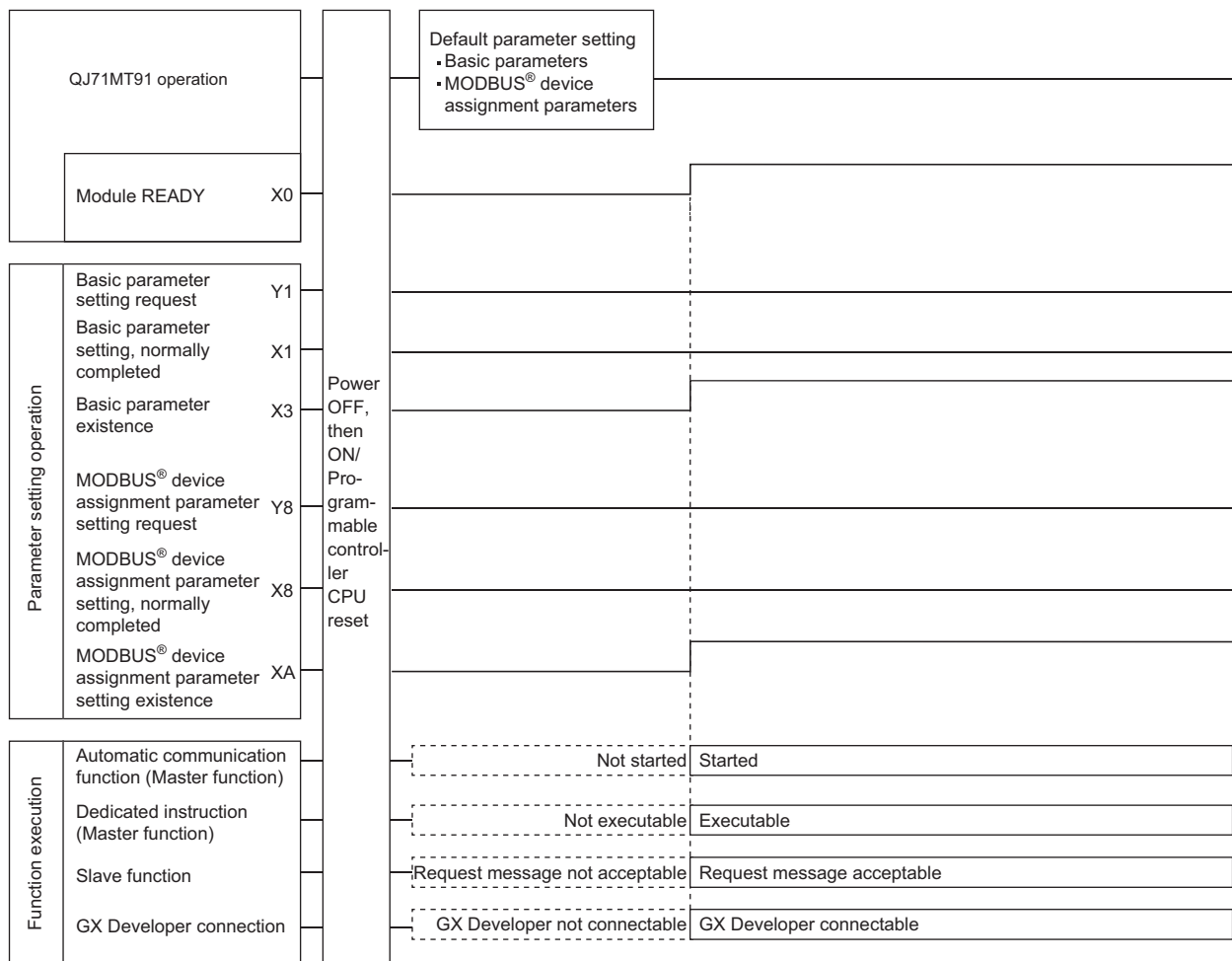

- (b) When the basic parameter starting method is ON (start with the user-set parameters) and the MODBUS® device assignment parameter starting method is OFF (start with the default parameters)

[Intelligent function module switch setting]

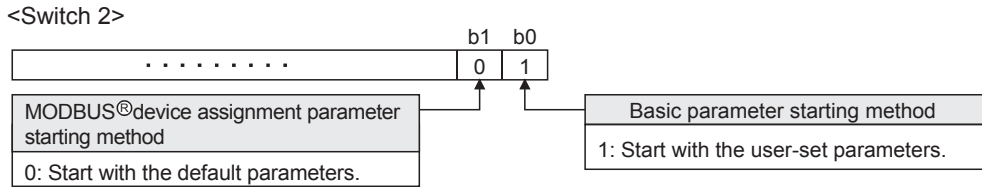

[Communication starting conditions]

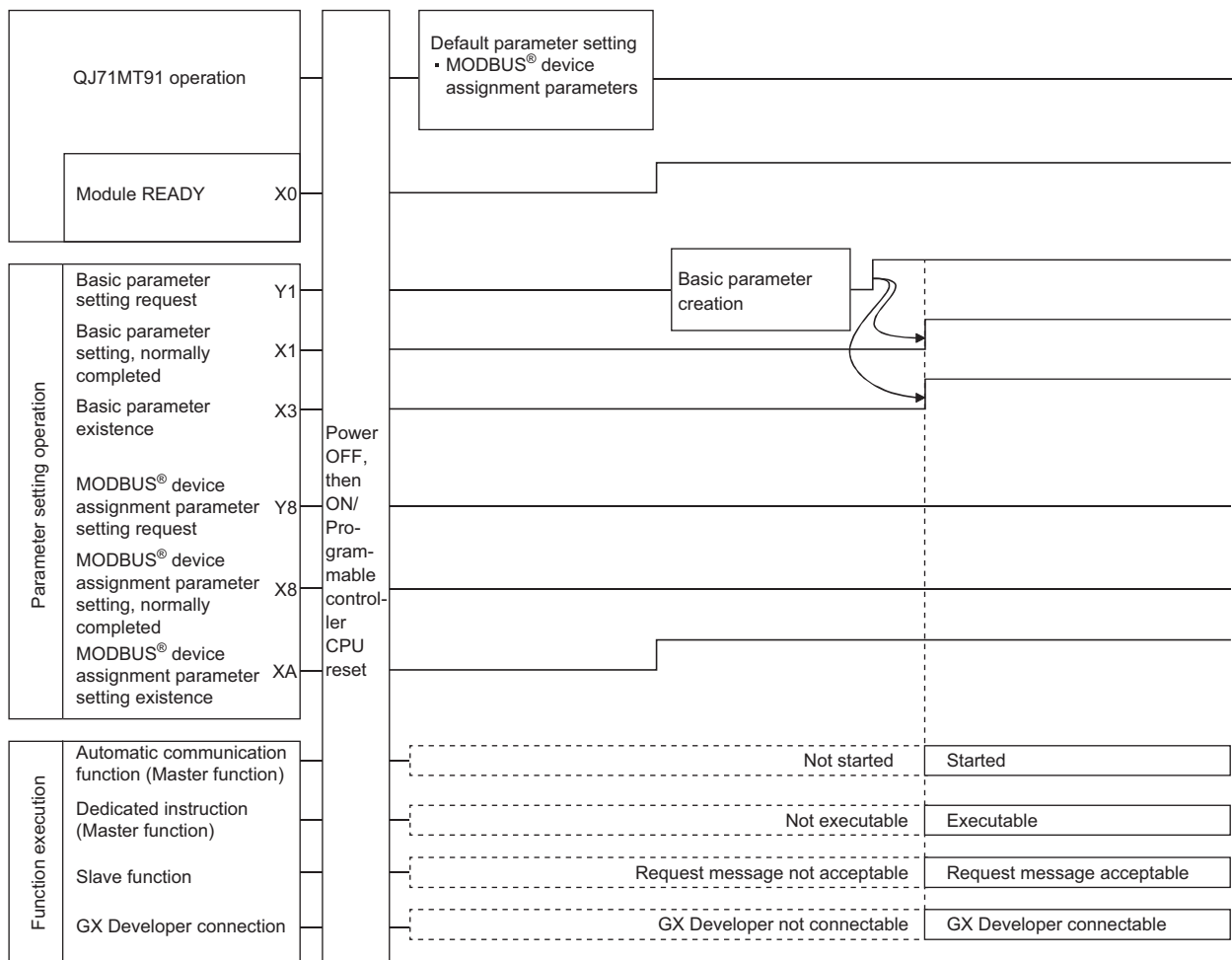

- (c) When the basic parameter starting method is OFF (start with the default parameters) and the MODBUS® device assignment parameter starting method is ON (start with the user-set parameters)

[Intelligent function module switch setting]

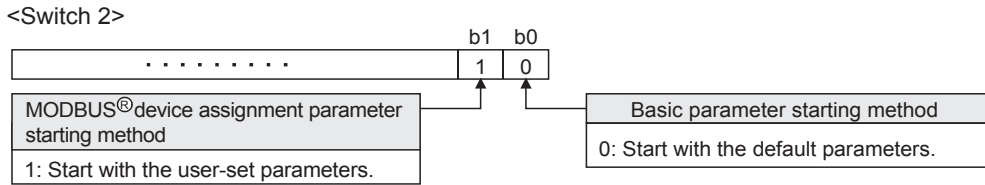

[Communication starting conditions]

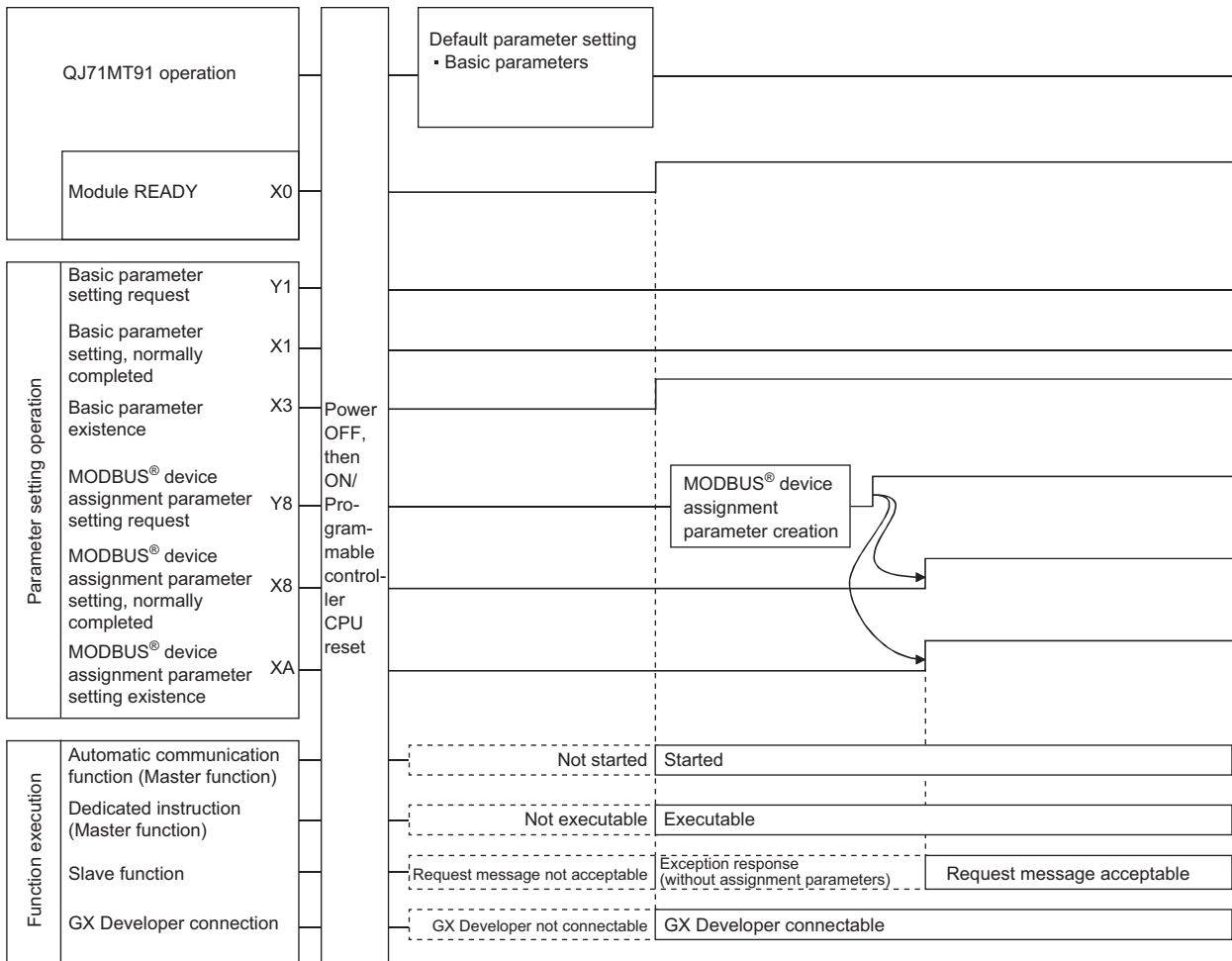

- (d) When the basic parameter starting method is ON (start with the user-set parameters) and the MODBUS® device assignment parameter starting method is ON (start with the user-set parameters)

[Intelligent function module switch setting]

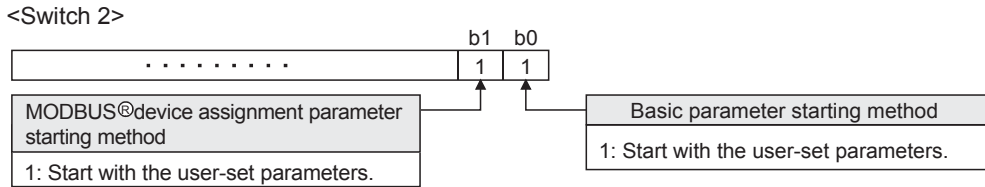

[Communication starting conditions]

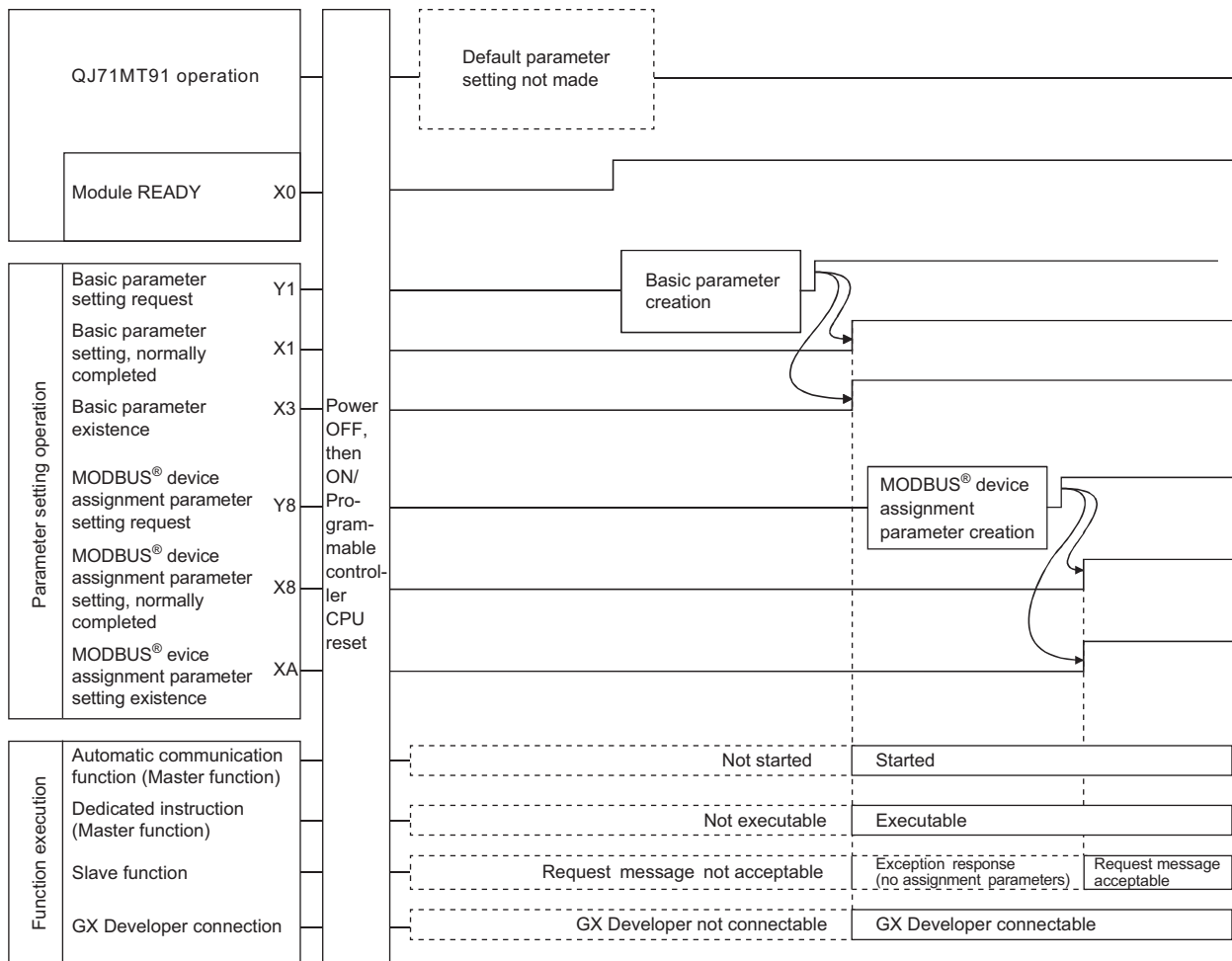

7 PARAMETER SETTING

This chapter explains the settings of the parameters.

7.1 Parameter Settings and Setting Procedure

(1) Parameter types

To use the QJ71MT91, set the following parameters as necessary.

(a) Basic parameters

Set the basic information necessary for the QJ71MT91.

When using the preset initial values of the QJ71MT91, no setting is required.

Refer to Section 7.2 for details.

(b) Automatic communication parameters

Set the automatic communication parameters when using the automatic communication function with the QJ71MT91 acting as the master.

Refer to Section 7.3 for details.

If the automatic communication function is not to be used, setting of these parameters are not required.

(c) MODBUS® device assignment parameters

Set the MODBUS® device assignment parameters when using the MODBUS® device assignment function with the QJ71MT91 acting as a slave.

When using the initial values preset to the QJ71MT91, no setting is required for these parameters.

Refer to Section 7.4 for details.

(2) Parameter setting method

Set the parameters to the QJ71MT91 by any of the following methods.

(a) Setting from utility package

Set the parameters from the GX Configurator-MB utility package.

Refer to Chapter 8 for details.

(b) Setting from sequence program

Set the parameters from the sequence program.

Refer to Chapter 9 for details.

(c) Setting with GX Works2

Add the QJ71MT91 to the data of the intelligent function module in GX Works2 for the settings.

For how to operate the data of an intelligent function module, refer to the GX Works2 Version 1 Operating Manual (Intelligent Function Module).

(3) Parameter setting procedures

Set the parameters in the following procedures.

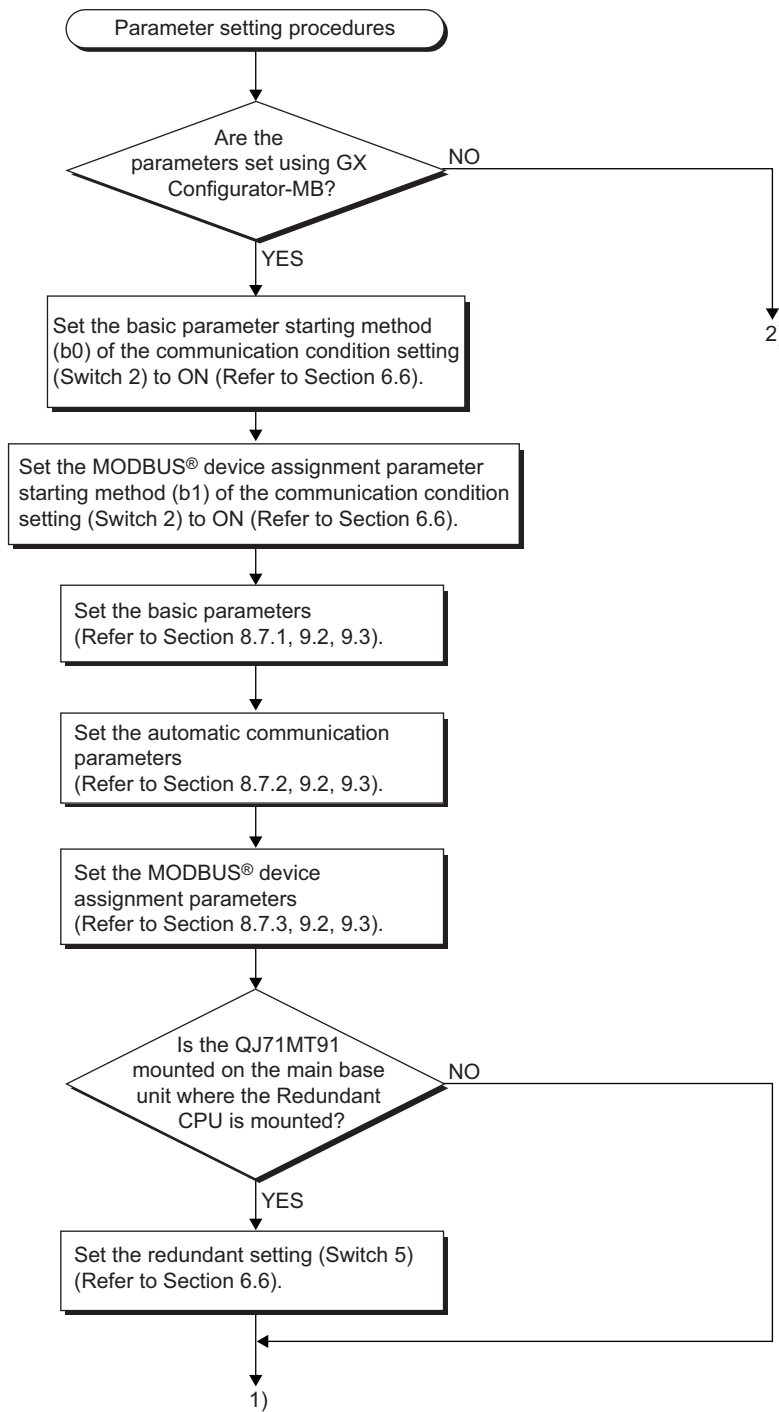

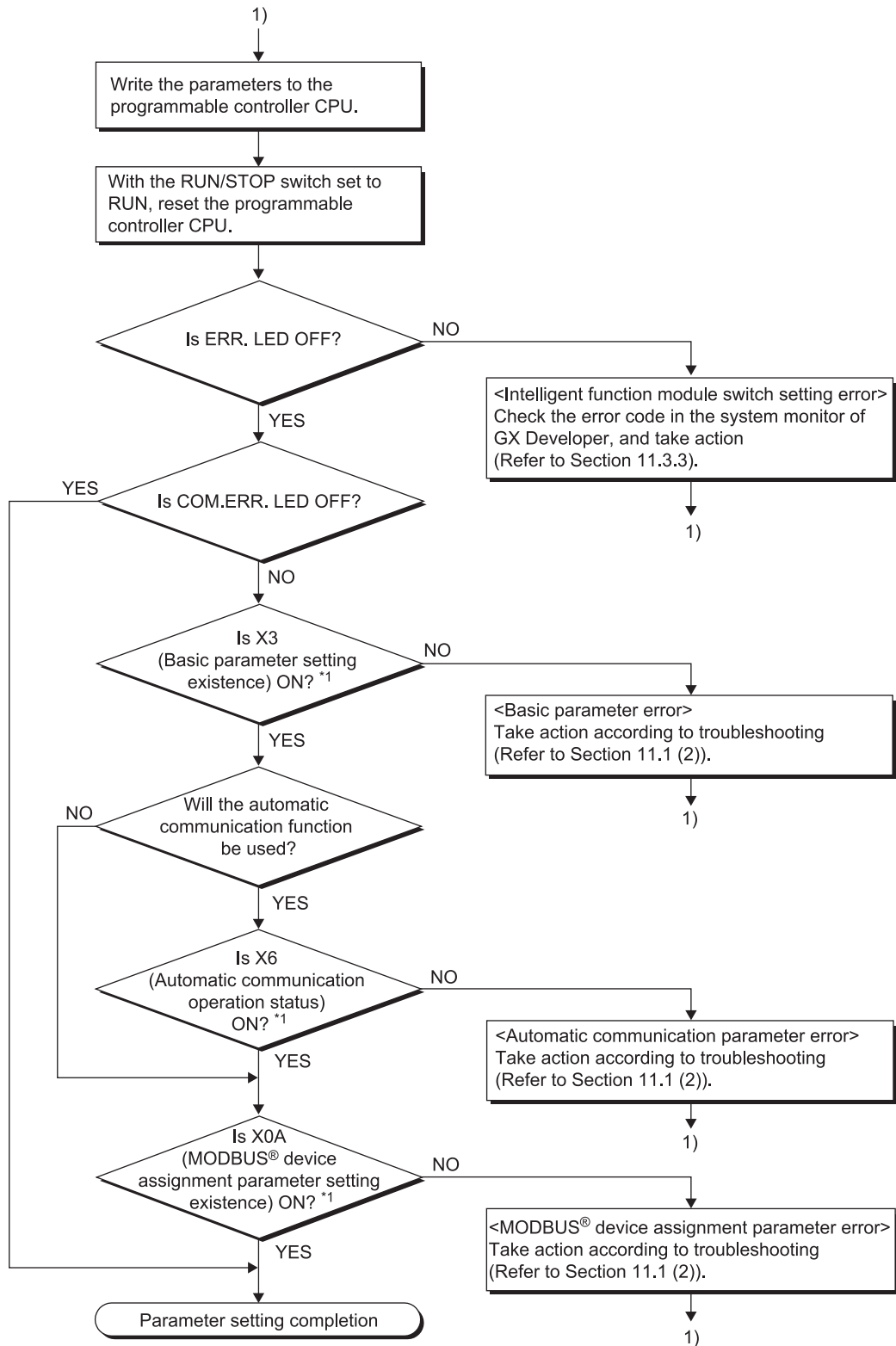

*1: The X signal status can be confirmed using GX Configurator-MB. (Refer to Section 8.6.)

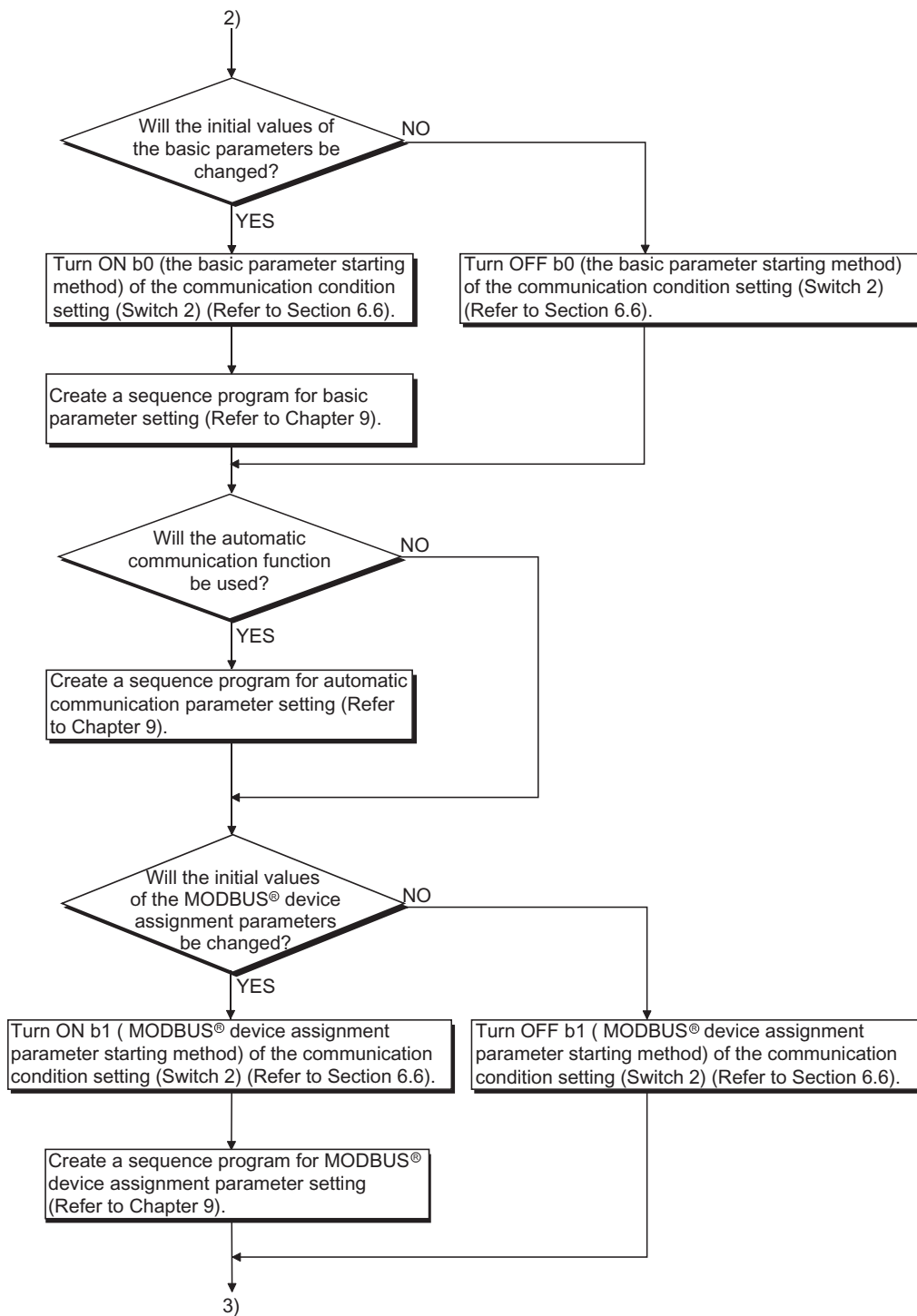

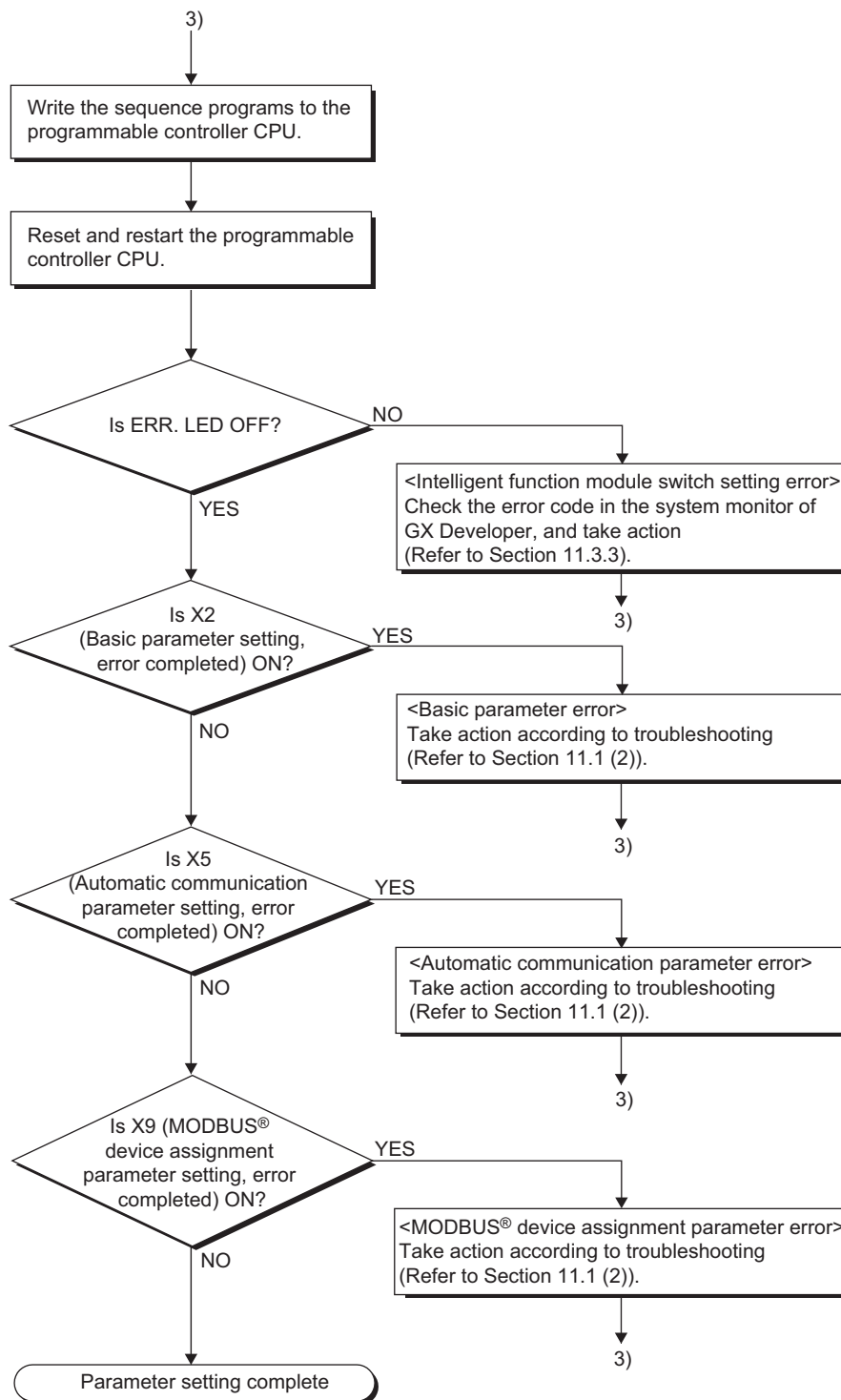

7.2 Basic Parameters

7.2.1 Basic parameters details

The basic parameters are classified into the following three types.

(1) TCP/UDP/IP setting

Address	Parameter Name		Setting Range	Initial Value	
0000H (0)	TCP/UDP/IP monitoring timer	TCP ULP timer value Set time = set value × 500ms	2 to 2400	60	
0001H (1)		TCP zero window timer value Set time = set value × 500ms	2 to 2400	20	
0002H (2)		TCP resend timer value Set time = set value × 500ms	2 to 2400	20	
0003H (3)		TCP end timer value Set time = set value × 500ms	2 to 2400	40	
0004H (4)		IP reassembly timer value Set time = set value × 500ms	1 to 2399	10	
0005H (5)		Split reception monitoring timer value Set time = set value × 500ms	2 to 2400	60	
0006H (6)	KeepAlive	KeepAlive	0: Not used 1: Used	1	
0007H (7)		KeepAlive start timer value Set time = set value × 500ms	1 to 32767	1200	
0008H (8)		KeepAlive interval timer value Set time = set value × 500ms	1 to 32767	20	
0009H (9)		KeepAlive resend count	1 to 10	3	
000AH (10)	Routing information	Router relay function	0: Not used 1: Used	0	
000BH to 000CH (11 to 12)		Subnet mask pattern	C0000000H to FFFFFFFCH	FFFFFFF0H	
000DH to 000EH (13 to 14)		Default router IP address	Refer to Section 7.2.2 (3) (c)	00000000H	
000FH (15)		Number of routers set	0 to 8	0	
0010H to 0011H (16 to 17)		Router information 1	Subnet address	Refer to Section 7.2.2 (3) (e)	00000000H
0012H to 0013H (18 to 19)			Router IP address	Refer to Section 7.2.2 (3) (f)	00000000H
0014H to 002FH (20 to 47)		Router information 2 to 8	(Same as router information 1)		

(2) GX Developer connection information setting

Address	Parameter Name	Setting Range	Initial Value
0030H (48)	Number of TCP connections for GX Developer connection	0 to 8	1

(3) MODBUS® /TCP setting

Address	Parameter Name	Setting Range	Initial Value
0110H (272)	Local slave station port No.	1 to 4999, 5020 to 65535 ^(*1)	502
0111H (273)	Target slave port No. for automatic communication function	1 to 65535 ^(*1)	502
0114H (276)	CPU response monitoring timer value Set time = set value × 500ms	1 to 2400	10
0115H to 0116H (277 to 278)	Preferred node specification 1	IP address	Refer to Section 7.2.4 (4) (b)
0117H (279)		Number of connections	0 to 64
0118H to 01D4H (280 to 468)	Preferred node specification 2 to 64	(Same as Preferred node specification 1)	

*1: When specifying a value of 32768 (8000H) or more in a sequence program, set the value in hexadecimal.

7.2.2 TCP/UDP/IP setting

(1) TCP/UDP/IP monitoring timer

(a) TCP ULP timer value

- 1) Set the ACK monitoring time for opening TCP connection and sending data. If no ACK has been received from the target device for a predetermined period of time, the connection is forcibly closed.
- 2) No setting is required when the default value is used.

(b) TCP zero window timer value

- 1) The window indicates the receive buffer on the receiving side.
- 2) When the receive buffer on the receiving side becomes full (window size = 0), data transmission is held until the receive buffer has free space.
In such a case, the sender sends a window check packet to the receiver according to the TCP zero window timer value to check whether data can be received or not.
- 3) No setting is required when the default value is used.

(c) TCP resend timer value

- 1) Set the resend time for the case where ACK is not returned when TCP connection is opened and TCP data are transmitted. This timer is also used for the time for resending an ARP request in the case where a response is not returned in reply to the sent ARP request. (ARP is resent at the TCP resend timer value/2.)
- 2) No setting is required when the default value is used.

(d) TCP end timer value

- 1) When TCP connection is closed from the local station, the local station sends FIN to the target device, and receives ACK and then FIN from the target device. Set the monitoring time for which the station will wait for FIN from the target device.
- 2) If FIN is not received from the target device when the TCP end timer is expired, RST is sent to the target device, forcing the connection to close.
- 3) No setting is required when the default value is used.

(e) IP reassembly timer value

- 1) In data communications, a block of data may be split into segments on an IP level due to the send/receive station buffer limitations.
- 2) Set the time for waiting for the next split data segment in the case where the QJ71MT91 receives and restores the split data.
- 3) No setting is required when the initial value is used.

(f) Split reception monitoring timer value

- 1) Set the time from the receipt of the first message segment until the receipt of the last message segment in the case where messages split on a TCP/UDP level are received.
- 2) No setting is required when the default value is used.

REMARK

- (1) Specify the QJ71MT91 side timer values that will satisfy the following conditions.

$$\begin{aligned} & \bullet \left(\begin{array}{l} \text{Automatic} \\ \text{communication response} \\ \text{monitoring timer value} \end{array} \right)^{*1} \geq \left(\begin{array}{l} \text{Split reception} \\ \text{monitoring} \\ \text{timer value} \end{array} \right) \geq \left(\begin{array}{l} \text{TCP ULP} \\ \text{timer} \\ \text{value} \end{array} \right) \geq \left(\begin{array}{l} \text{TCP end} \\ \text{timer} \\ \text{value} \end{array} \right) \geq \left(\begin{array}{l} \text{TCP} \\ \text{resend} \\ \text{timer value} \end{array} \right) > \left(\begin{array}{l} \text{IP} \\ \text{reassemble} \\ \text{timer value} \end{array} \right) \\ & \bullet \left(\begin{array}{l} \text{Response monitoring} \\ \text{timer value for dedicated} \\ \text{instruction} \end{array} \right)^{*2} \geq \left(\begin{array}{l} \text{Split reception} \\ \text{monitoring} \\ \text{timer value} \end{array} \right) \geq \left(\begin{array}{l} \text{TCP ULP} \\ \text{timer} \\ \text{value} \end{array} \right) \geq \left(\begin{array}{l} \text{TCP end} \\ \text{timer} \\ \text{value} \end{array} \right) \geq \left(\begin{array}{l} \text{TCP} \\ \text{resend} \\ \text{timer value} \end{array} \right) > \left(\begin{array}{l} \text{IP} \\ \text{reassemble} \\ \text{timer value} \end{array} \right) \end{aligned}$$

*1: Automatic communication response monitoring timer value is a response monitoring timer value for the automatic communication function.

Refer to Section 7.3 for details.

*2: Refer to Section 10.2 or 10.3 for details.

When making communication between two QJ71MT91s, perform the same settings to both modules.

- (2) Specify the target device side timer values that will satisfy the following conditions.

If the timer values are not as indicated below, communication errors, such as send time-out, may occur frequently.

$$\begin{aligned} & \bullet \left(\begin{array}{l} \text{Target device side TCP} \\ \text{resend timer value} \end{array} \right) > \left(\begin{array}{l} \text{QJ71MT91 side TCP} \\ \text{resend timer value} \end{array} \right) \\ & \bullet \left(\begin{array}{l} \text{Monitoring timer value on target} \\ \text{device side application software} \end{array} \right) > \left\{ \left(\begin{array}{l} \text{CPU response} \\ \text{monitoring} \\ \text{timer value} \end{array} \right)^{*2} + \left(\begin{array}{l} \text{QJ71MT91 side} \\ \text{TCP ULP timer} \\ \text{value} \end{array} \right) \times n^{*1} \right\} \end{aligned}$$

*1: n indicates a TCP split transmission count, which is obtained from the following calculation.

$$n = \left\lceil \frac{\text{Message size sent by QJ71MT91}}{\text{Maximum Segment size}} \right\rceil \text{ rounded up to nearest integer}$$

*2: Refer to Section 7.3 for the CPU response monitoring timer value.

- (Example 1) TCP split transmission count for communication on the same line
The Maximum Segment size is 1460 bytes on the same line (with no router relayed) and the TCP split transmission count is as described below.

When QJ71MT91 send message size \leq 1460 bytes, $n = 1$

When 1460 bytes < QJ71MT91 send message size, $n = 2$

(Example 2) TCP split transmission count for communication on the other line
The Maximum Segment size is a minimum of 536 bytes on the other line (e.g. via a dial-up router) and the TCP split transmission count is as described below.

When QJ71MT91 transmission message size ≤ 536 bytes, $n = 1$

When $536 \text{ bytes} < \text{QJ71MT91 transmission message size} \leq 1072$ bytes, $n = 2$

When $1072 \text{ bytes} < \text{QJ71MT91 transmission message size} \leq 1608$ bytes, $n = 3$

(3) When a communication error occurs due to noise, etc., change the setting to increase the retry count.

The retry count is determined by the following expression.

(In the case of the default value, $2 = (60 / 20) - 1$)

$$\bullet \left(\begin{array}{c} \text{Retry} \\ \text{count} \end{array} \right) = \left\{ \left[\frac{\text{TCP ULP timer value}}{\text{TCP resend timer value}} \right] - 1 \right\}$$

(2) KeepAlive function

(a) KeepAlive

- 1) Set whether the KeepAlive function will be used or not.

Setting name	Setting
Not used	KeepAlive function is not used
Used	KeepAlive function is used

- 2) No setting is required when the default value is used.

(b) KeepAlive start timer value

- 1) Set the time interval from the stop of communication with the target device to the start of alive check for the TCP connection opened with KeepAlive valid.
- 2) No setting is required when the default value is used.

(c) KeepAlive interval timer value

- 1) Set the alive recheck interval time for the case that no response from the target device can be received through the TCP connection opened with KeepAlive valid.
- 2) No setting is required when the default value is used.

(d) KeepAlive resend count

- 1) Set how many times the KeepAlive check message will be resent to the target device when no response can be received through the TCP connection opened with KeepAlive valid.
- 2) No setting is required when the default value is used.

(3) Routing information

(a) Router relay function

- 1) Set whether the router relay function will be used or not.
The router relay function is not needed when the QJ71MT91 communicates with the target device on the same Ethernet (the subnet address of the IP address is the same).
- 2) The router relay function allows communication with devices on other Ethernets via routers and gateways.
(The router relay function does not mean a function with which the QJ71MT91 acts as a router.)
- 3) One default router and a maximum of any eight routers can be set for the router relay function.

(b) Subnet mask pattern

- 1) Set the subnet mask. *1 (Setting range: C0000000H to FFFFFFFCH)
Consult the network administrator for the setting.
- 2) When not using the subnet mask, set any of the following table values according to the class.

Class	Mask value
Class A	FF000000H
Class B	FFFF0000H
Class C	FFFFFF00H

*1 Networks constructed by Ethernet include small-scaled network systems where multiple devices are connected to one Ethernet, and medium- and large-scaled network systems where multiple small-scaled networks are connected by routers, etc.

The subnet mask logically divides one network, where many devices are connected, into multiple sub-networks to facilitate administration.

(Example) Class B

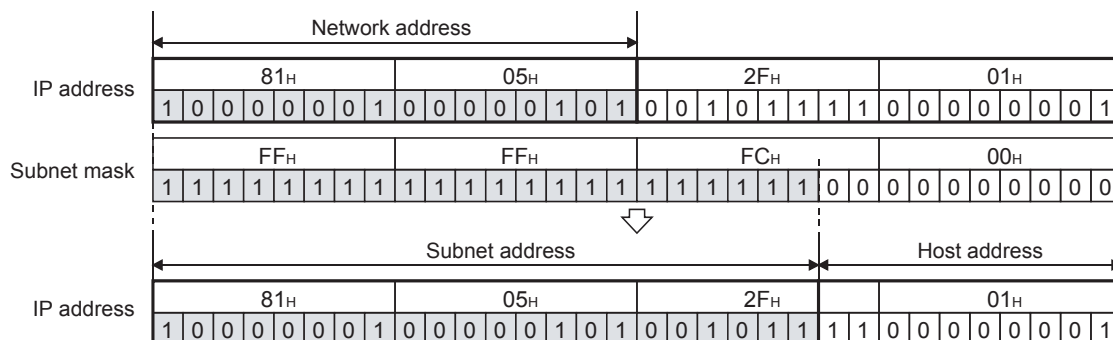

POINT

- (1) All devices on the same sub-network must have common subnet masks.
- (2) When not administrated by the sub-network, the connected devices need not have subnet masks. (Set the network address of the corresponding class.)

(c) Default router IP address

Set the IP address of the router (default router) to be used when the QJ71MT91 communicates with the target device on another Ethernet via other than the router specified in the router information (refer to (e) below).

Set the value that satisfies the following conditions.

- Condition 1: The IP address class is any of A, B and C.
- Condition 2: The subnet address of the default router is the same as that of the local station QJ71MT91.
- Condition 3: The host address bits are not all "0" or all "1".

POINT

The default router is used for communication if the corresponding subnet address does not exist in the router information (refer to (e) below) at data transmission.
--

(d) Number of routers set

- 1) Set the number of routers (within the allowable range) according to (e) Subnet address and (f) Router IP address below when the QJ71MT91 communicates with the target device on another Ethernet via other than the default router.
- 2) Set the necessary number of subnet addresses and router IP addresses to the areas of (e) and (f) below.

(e) Router information: Subnet address

- 1) Set the network address (*1) or subnet address (*2) of the target device when the QJ71MT91 communicates with the target device on another Ethernet via other than the default router.
Set the value that satisfies the following conditions.
Condition 1: The IP address class is any of A, B and C.
Condition 2: All the host address bits are "0".
- 2) Set the router information in order, starting from the first target device.

*1 Set the network address of the target device when the class (network address) of the local station QJ71MT91 differs from that of the target device.

*2 Set the subnet address of the target device when the class (network address) of the local station QJ71MT91 is the same as that of the target device.

3) Subnet address setting examples

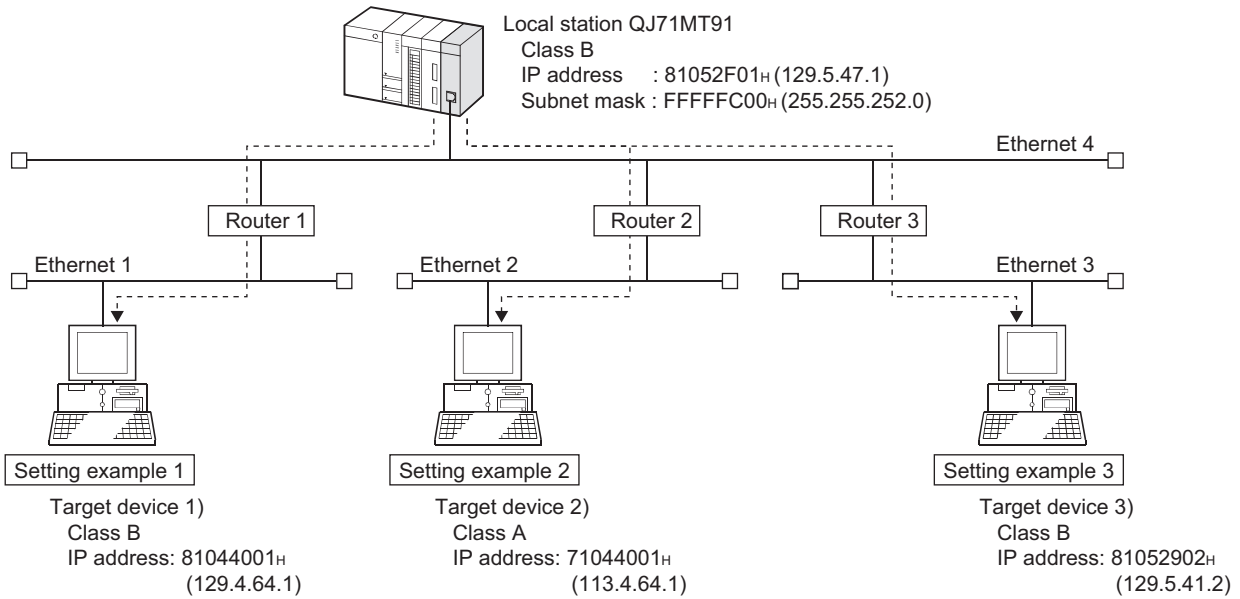

(Setting example 1) When the network addresses of the local station QJ71MT91 and target device differ

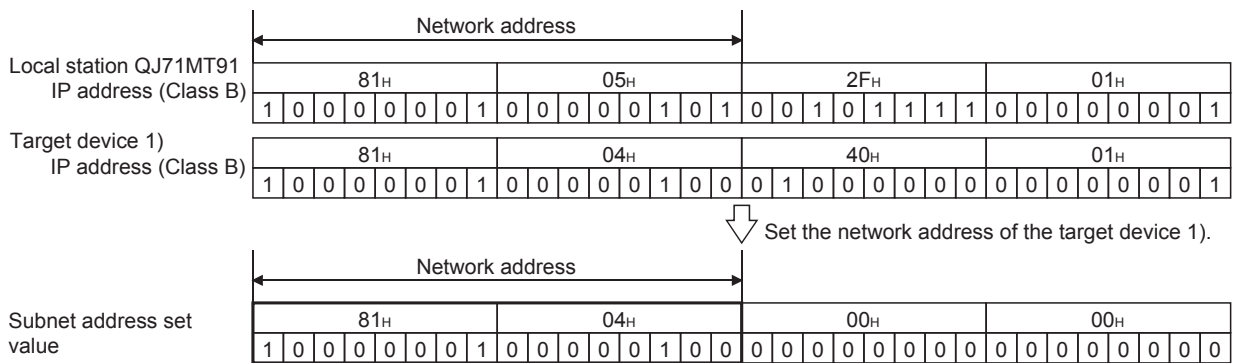

(Setting example 2) When the classes of the local station QJ71MT91 and target device differ

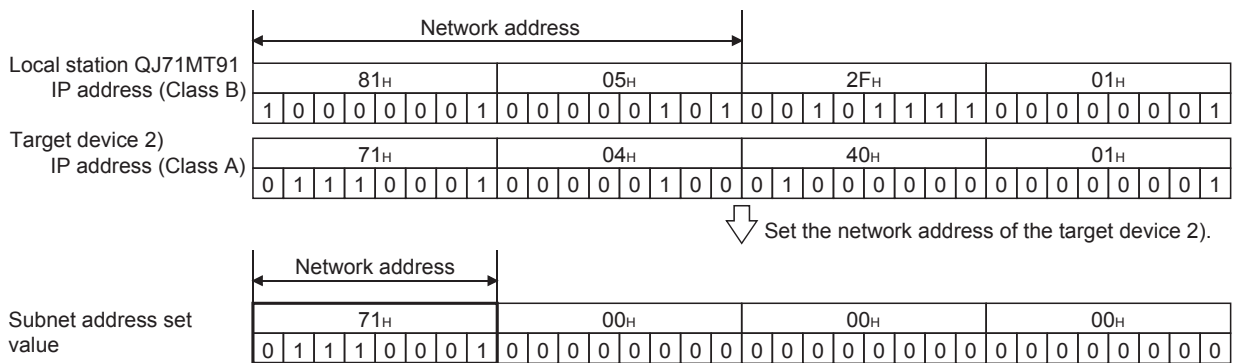

(Setting example 3) When the network addresses of the local station QJ71MT91 and target device are the same

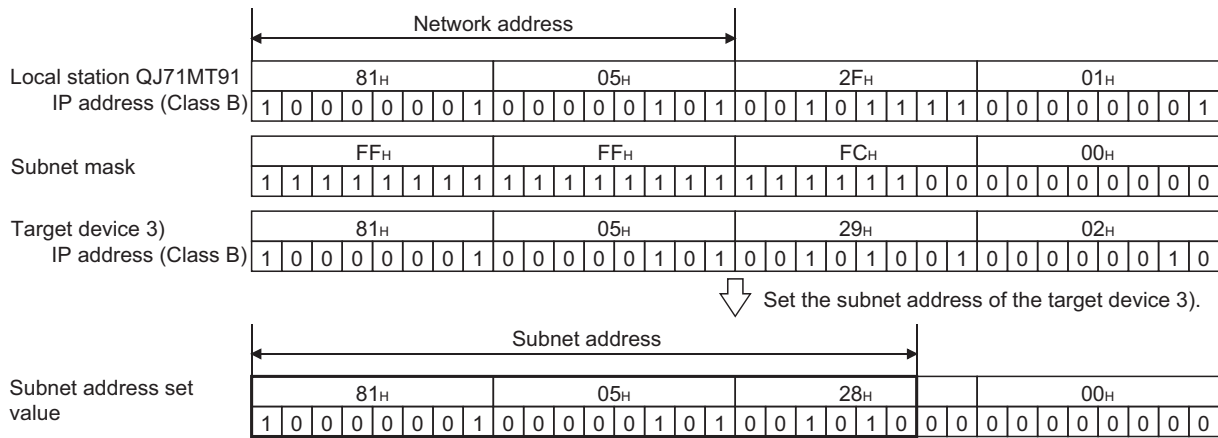

(f) Router information: Router IP address

Set the IP addresses of the routers to be used when the QJ71MT91 communicates with the target devices on other Ethernets via other than the default router.

Set the value that satisfies the following conditions.

- Condition 1: The IP address class is any of A, B and C.
- Condition 2: The subnet address of the router is the same as that of the local station QJ71MT91.
- Condition 3: The host address bits are not all "0" or all "1".

POINT
(1) The router relay function is not needed for communication when the slave function of the QJ71MT91 is used to make communication with the master device on another Ethernet.
(2) The router relay function is not needed in a system that uses the Proxy router.

7.2.3 GX Developer connection information setting

- (1) Number of TCP connections for GX Developer connection
 - (a) TCP connections for GX Developer connection represents connections for connecting GX Developer using the TCP protocol.
Set the desired number to the Number of TCP connections for GX Developer connection.
 - (b) TCP connections for GX Developer connection are handled as preferred connections.
 - (c) When GX Developer is connected using the UDP protocol, no setting is required for the Number of TCP connections for GX Developer connection.

7.2.4 MODBUS®/TCP setting

(1) Local slave station port No.

Set the port No. on the QJ71MT91 side for receiving a request message from the master using the slave function of the QJ71MT91.

POINT
<p>(1) The specifications of the MODBUS® /TCP protocol define that "502" should be used as the port No. for the slave. In this setting, the default value is "502" and normally need not be changed.</p> <p>(2) When specifying a value of 32768 (8000H) or more in a sequence program, set the value in hexadecimal.</p>

(2) Target slave port No. for automatic communication function

Set the target slave port No. for issuing a request message using the automatic communication function (master function) of the QJ71MT91.

POINT
<p>(1) The specifications of the MODBUS® /TCP protocol define that "502" should be used as the port No. for the slave. In this setting, the default value is "502" and normally need not be changed.</p> <p>(2) When specifying a value of 32768 (8000H) or more in a sequence program, set the value in hexadecimal.</p>

(3) CPU response monitoring timer value

(a) When the QJ71MT91 receives a request message from the master and the programmable controller CPU starts its processing, the QJ71MT91 waits for the response from the programmable controller CPU. The time allowed for the QJ71MT91 to wait is set by the CPU response monitoring timer value.

This timer allows the QJ71MT91 to cancel the wait status on the master side when a response to the master is not available due to an error occurred in the programmable controller CPU.

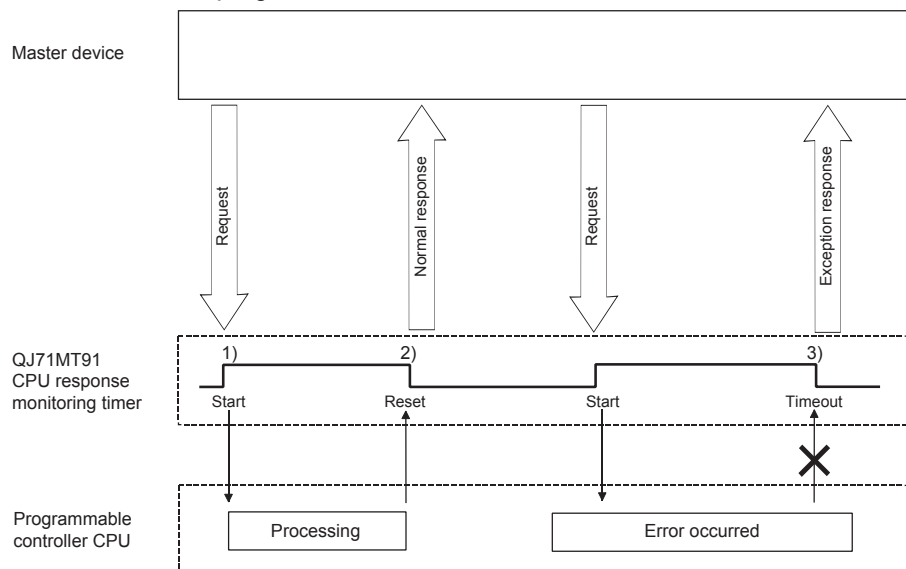

- (b) The QJ71MT91 starts the CPU response monitoring timer when it receives a request message from the master. (1) in the figure)
The CPU response monitoring timer monitors the programmable controller CPU processing until the QJ71MT91 starts sending a response message to the master. (2) in the figure)
- (c) When the CPU response monitoring timer reaches the preset time, the QJ71MT91 performs the following processings. (3) in the figure)
- 1) Issues the error code: 7380H. *1
 - 2) Issues the exception code: 04H to the master side. *2
- *1: Refer to Section 11.3.3 for details of the error code.
*2: Refer to Section 11.3.2 for details of the exception code.

POINT

When the CPU response monitoring timer value is "0ms", the QJ71MT91 waits until the programmable controller CPU completes processing. (Limitless waiting)

- (4) Preferred node specification
- (a) Relationship between preferred node specification and TCP connection opening and closing
- 1) The QJ71MT91 opens and closes TCP connections automatically.
 - 2) The QJ71MT91 can open up to 64 TCP connections simultaneously.
 - 3) Before opening a new TCP connection in addition to already open 64 TCP connections, the QJ71MT91 automatically closes the TCP connection that has not communicated for the longest time among the non-communicating ones.
At this time, the TCP connections with the target devices specified as the preferred nodes are not closed.
 - 4) If the number of TCP connections used by the QJ71MT91 exceeds 64, specify the preferred nodes for the target devices that must keep the TCP connections open.
 - 5) Up to 64 preferred nodes can be specified.
- (b) Preferred node specification: IP address
- 1) Set the IP address of the target device to be specified for the preferred node.
 - 2) Set the value that satisfies the following conditions.
Condition 1: The IP address class is any of A, B and C.
Condition 2: The host address bits are not all "0" or all "1".
- (c) Preferred node specification: TCP connection
- 1) Specify the number of TCP connections used for communication with the specified preferred nodes.
 - 2) Set the value that satisfies the following condition.
(Preferred node specification 1: TCP connection + ... + preferred node specification 64: TCP connection) + number of TCP connections for GX Developer connection \leq 64

POINT

It is not necessary to use the preferred node specification when the total number of TCP connections used by the QJ71MT91 is not more than 64.
--

7.3 Automatic Communication Parameters

7.3.1 Automatic communication parameters details

Address	Parameter Name		Setting Range	Default Value	
0200H to 0201H (512 to 513)	Automatic communication parameter 1	Target station IP address	Refer to (1) in this section. (00000000H: Automatic communication parameter not set)	00000000H	
0202H (514)		Module ID	0 to 255 Target device 1) MODBUS [®] /Serial 0: Broadcast 1 to 247: MODBUS [®] /Serial device station No. 2) MODBUS [®] /TCP: 255	255	
0203H (515)		Repeat interval timer value Set time = set value × 10ms	0 to 65535	0	
0204H (516)		Response monitoring timer value Set time = set value × 500ms	0,2 to 2400 When the set value is 0, the QJ71MT91 operates at 60 (30s).	0	
0205H (517)		Type specification of the target MODBUS [®] device	0000H: Not specified 0100H: Read coils 0200H: Read discrete inputs 0400H: Read input registers 0500H: Read holding registers 0001H: Write coils 0005H: Write multiple registers 0505H: Read/Write multiple registers	0000H	
0206H (518)		Read setting	Head buffer memory address	1000H to 1FFFH	0000H
0207H (519)			Target MODBUS [®] device head number	0 to 65535 (*1)	0
0208H (520)			Access points (*2)	0 to 2000	0
0209H (521)		Write setting	Head buffer memory address	3000H to 3FFFH	0000H
020AH (522)			Target MODBUS [®] device head number	0 to 65535 (*1)	0
020BH (523)			Access points (*2)	0 to 1968	0
020CH to 04FFH (524 to 1279)		Automatic communication parameter 2 to 64	(Same as in automatic communication parameter 1)		

*1: When specifying a value of 32768 (8000H) or more in a sequence program, set the value in hexadecimal.

*2: The setting range and default value of the access points change depending on the target MODBUS[®] device type. Refer to (8) in this section.

- (1) Target station IP address
 - (a) Set the IP address of the target slave device.
 - (b) When the target slave device is on another Ethernet and an access is to be made via a router, set the router relay function of the basic parameter to "1: Used" and set the routing information of the basic parameter.
Refer to Section 7.2 for the routing information.
 - (c) Set the value that satisfies the following conditions.
Condition 1: The IP address class is any of A, B and C.
Condition 2: The host address bits are not all "0" or all "1".
- (2) Module ID
 - (a) Set the module ID when specifying the slave connected to the other line, such as a line using the MODBUS[®] Serial protocol.
 - (b) The module ID is embedded into a request message to be sent to a target slave device.
Refer to Section 4.2 for the frame specifications of the request message.
- (3) Repeat interval timer value
 - (a) The repeat interval timer value represents the time from when the QJ71MT91 receives a response message from the slave until it sends a next message to the slave.
 - (b) Overlap of send and receive processings may cause delay and take more time than the interval time set to the repeat interval timer.
 - (c) The initial value is "0".
When the repeat interval timer value is "0", the QJ71MT91 will issue a next request message immediately after it has received a response message from the slave.
If unable to do so, check the time until that the slave station can process the next request message. After that, set the above time or more of a value to the repeat interval timer value.
 - (d) The accuracy of the repeat interval timer is "0 to -10ms".
- (4) Response monitoring timer value
 - (a) The response monitoring timer value represents the time from when the QJ71MT91 issues a request message to the slave until it receives a response message from the slave.
 - (b) If the QJ71MT91 does not receive a response message from the slave before the response monitoring timer expires, it judges the target slave as faulty.
When an error status occurs, the corresponding automatic communication operation status storage area in the buffer memory turns on in the QJ71MT91.
Also, the error code is stored in the automatic communication error code storage area.
Refer to Section 11.3.1 for details of the automatic communication operation status storage area and automatic communication error code storage area.
 - (c) When the response monitoring timer value is "0", the QJ71MT91 operates at "60" (30s).

- (5) Type specification of the target MODBUS[®] device
 (a) Set the type of the read/write target MODBUS[®] device.

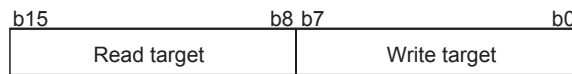

Set Value	Target MODBUS [®] Device Type
00H	Not specified
01H	Coil
02H	Input
04H	Input register
05H	Holding register

- (b) Setting range

The following table gives the combinations of read and write targets available for the target MODBUS[®] device type setting. Any other combinations are not available.

Type Specification of the Target MODBUS [®] Device			Issued Function Code	
Set value	Read target	Write target		
0100H	Coil	Not specified (*1)	01	Read coils
0200H	Input		02	Read discrete inputs
0400H	Input device		04	Read input registers
0500H	Holding register		03	Read holding registers
0001H	Not specified (*1)	Coil	15	Write multiple coils
0005H		Holding register	16	Write multiple registers
0505H		Holding register (*2)	23	Read/Write multiple registers

* 1: To perform only read or write, set "0" to each of the following:

- Head buffer memory address
- Target MODBUS[®] device head number
- Access points

* 2: Reading and writing can be performed simultaneously with one instruction only when 0505H (Read/write multiple registers) is set.

- (6) Head buffer memory address (Read setting/Write setting)
- (a) As the head buffer memory address, specify the head address of the buffer memory that will store the data read from or written to the slave.
- (b) The head buffer memory address must not be duplicated in the automatic communication parameters 1 to 64. Set different head buffer memory addresses to each of the automatic communication parameters.
- (7) Target MODBUS[®] device head number (Read setting/Write setting)
- (a) As the target MODBUS[®] device head number, specify the head number of the read or write target MODBUS[®] device.
- (b) As the target MODBUS[®] device head number, set "(last 5 digits of actual device number) - 1".
 Example: Set "17" when the head number of the holding register is 400018.
- (c) When specifying a value of 32768 (8000H) or more in a sequence program, set the value in hexadecimal.

(8) Access points (Read setting/Write setting)

- (a) Set the number of points to be written to the MODBUS[®] device and the number of points to be read from the MODBUS[®] device.
- (b) The access points change depending on the type specification of the target MODBUS[®] device.

Type Specification of the Target MODBUS [®] Device			Access Points Setting Range	
Set value	Read target	Write target	Points to be read	Points to be written
0100H	Coil	Not specified	1 to 2000 points	—
0200H	Input		1 to 2000 points	—
0400H	Input register		1 to 125 points	—
0500H	Holding register		1 to 125 points	—
0001H	Not specified	Coil	—	1 to 1968 points
0005H		Holding register	—	1 to 123 points
0505H	Holding register	Holding register	1 to 125 points	1 to 121 points

POINT

In the access to the bit device (coil/input) of the slave, the fraction bits are handled as described below.

1) Bit device read

Automatic communication parameter: Read setting			
Type specification of the target MODBUS [®] device	Head buffer memory address	Target MODBUS [®] device head number	Access points
0200H (Input)	1000H	16628	35

<QJ71MT91 buffer memory>

<Target slave device area>

2) Bit device write

Automatic communication parameter: Write setting			
Type specification of the target MODBUS [®] device	Head buffer memory address	Target MODBUS [®] device head number	Access points
0001H (Coil)	3000H	1305	5

<QJ71MT91 buffer memory>

<Target slave device area>

7.4 MODBUS® Device Assignment Parameters

Using MODBUS® device assignment parameters, the MODBUS® devices are correlated with the programmable controller CPU device memory. This allows direct access from the MODBUS® compatible master device to the programmable controller CPU device memory.

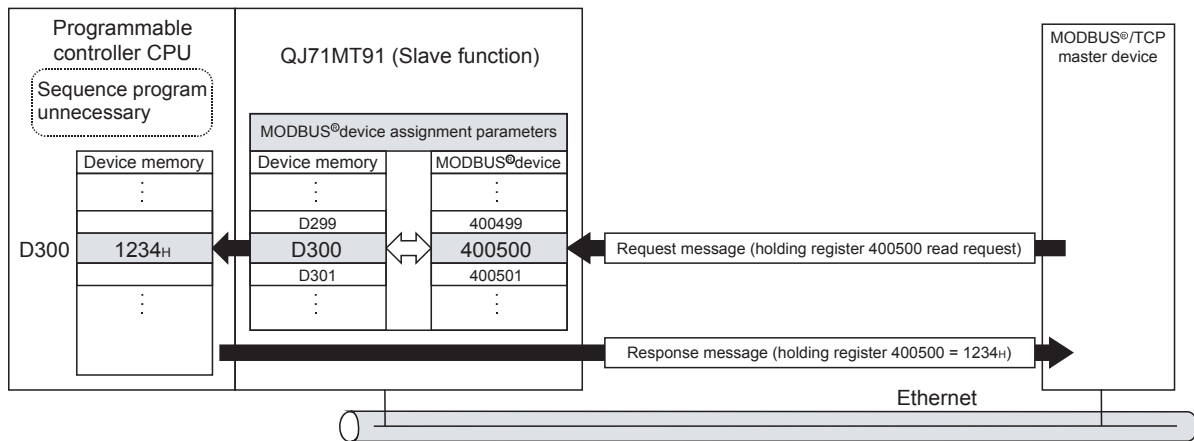

[Schematic image of MODBUS® device assignment parameter setting]

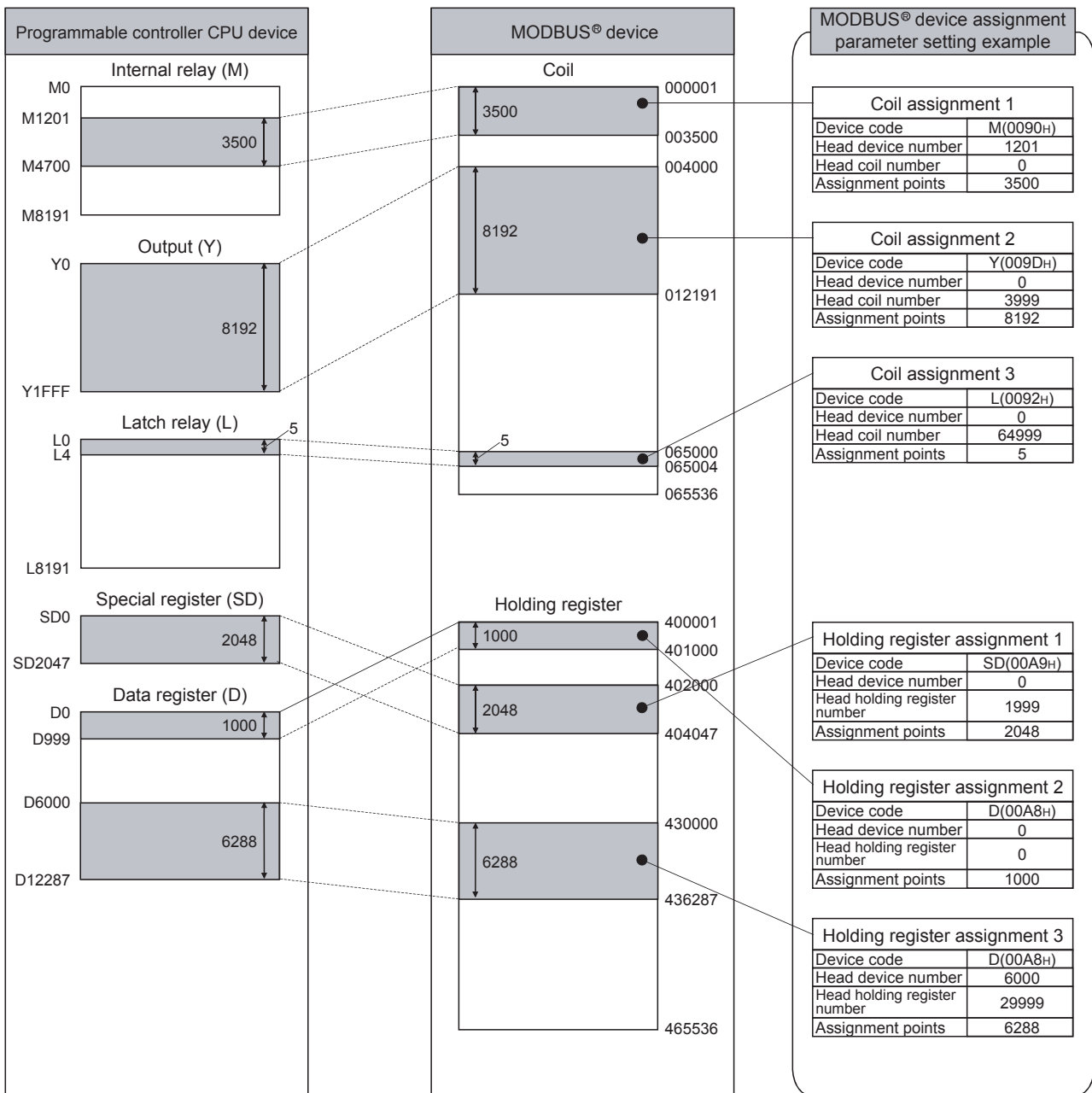

7.4.1 MODBUS® device sizes

The MODBUS® devices available for the QJ71MT91 are given in the following table.

MODBUS® Device Type	Read/Write	Access Points	MODBUS® Device Number
Coil	Read/Write	65536 points	000001 to 065536
Input	Read	65536 points	100001 to 165536
Input register	Read	65536 points	300001 to 365536
Holding register	Read/Write	65536 points	400001 to 465536
Extended file register	(*1)	4184064 points (*2)	File number: 0 to 418 (*2) 600000 to 609999

*1: The availability of extended file register read/write depends on that of the file register (ZR) read/write to the programmable controller CPU.

For example, if the file register (ZR) is stored on a Flash card, the extended file register is read only because the file register (ZR) is read only.

For details, refer to the QCPU user's manual (explanation, program fundamentals).

*2: The maximum access points and maximum file number of the extended file register depend on the file register (ZR) assignment size of the programmable controller CPU.

For details, refer to the QCPU user's manual (explanation, program fundamentals).

*3: Refer to Section 7.4.4 for the extended file register assignment.

7.4.2 MODBUS[®] device assignment parameters details

Address	Parameter Name		Setting Range	Default Value	
0900H (2304)	Coil	Coil assignment 1	Device code	0000H: Device code not assigned Other than 0000H: Device code	(*1)
0901H (2305)			Head device number	0000H to FFFFH	
0902H (2306)			Head coil number	0000H to FFFFH	
0903H (2307)			Assignment points	0000H to FFFFH	
0904H to 093FH (2308 to 2367)		Coil assignment 2 to 16	(Same as in coil assignment 1)		
0940H (2368)	Input	Input assignment 1	Device code	0000H: Device code not assigned Other than 0000H: Device code	(*1)
0941H (2369)			Head device number	0000H to FFFFH	
0942H (2370)			Head input number	0000H to FFFFH	
0943H (2371)			Assignment points	0000H to FFFFH	
0944H to 097FH (2372 to 2431)		Input assignment 2 to 16	(Same as in input assignment 1)		
0980H (2432)	Input register	Input register assignment 1	Device code	0000H: Device code not assigned Other than 0000H: Device code	(*1)
0981H (2433)			Head device number	0000H to FFFFH	
0982H (2434)			Head input register number	0000H to FFFFH	
0983H (2435)			Assignment points	0000H to FFFFH	
0984H to 09BFH (2436 to 2495)		Input register assignment 2 to 16	(Same as in input register assignment 1)		
09C0H (2496)	Holding register	Holding register assignment 1	Device code	0000H: Device code not assigned Other than 0000H: Device code	(*1)
09C1H (2497)			Head device number	0000H to FFFFH	
09C2H (2498)			Head holding register number	0000H to FFFFH	
09C3H (2499)			Assignment points	0000H to FFFFH	
09C4H to 09FFH (2500 to 2559)		Holding register assignment 2 to 16	(Same as in holding register assignment 1)		

*1: When the intelligent function switch 2 - MODBUS[®] device assignment parameter starting method (Bit 1) setting is "Start with the default parameters" (OFF), the default assignment parameters are used. The default parameter values are displayed on the MODBUS[®] device assignment parameter setting screen of GX Configurator-MB. Refer to Section 7.4.3 for the default assignment parameters.

POINT

With the intelligent function module switch, turn ON the MODBUS[®] device assignment parameter starting method. (Refer to Section 6.6)
If this switch is set to OFF, the operation will proceed based on the default assignment parameters. (Refer to Section 7.4.3)

(1) Device codes

- (a) Set the device codes for the programmable controller CPU devices and QJ71MT91 buffer memory area assigned to the MODBUS® devices.
- (b) The device codes have different setting ranges depending on the MODBUS® devices.

Refer to the following table for the device code setting ranges.

Classification	Device Name	Device Symbol	Device Code(*5)	Assignable MODBUS® Device					
				Coil	Input	Input register	Holding register	Extended file register	
Internal system device	Special relay	SM(*3)	0091H	○	○				
	Special register	SD(*3)	00A9H			○	○		
Internal user device	Input	X(*3)	009CH	○	○				
	Output	Y(*3)	009DH	○	○				
	Internal relay	M(*3)	0090H	○	○				
	Latch relay	L	0092H	○	○				
	Annunciator	F	0093H	○	○				
	Edge relay	V	0094H	○	○				
	Link relay	B(*3)(*4)	00A0H	○	○				
	Data register	D(*3)(*6)	00A8H			○	○		
	Link register	W(*3)(*4)(*6)	00B4H			○	○		
	Timer	Coil	TC	00C0H	○	○			
		Contact	TS	00C1H	○	○			
		Current value	TN	00C2H			○	○	
	Retentive timer	Coil	SC	00C6H	○	○			
		Contact	SS	00C7H	○	○			
		Current value	SN	00C8H			○	○	
	Counter	Coil	CC	00C3H	○	○			
		Contact	CS	00C4H	○	○			
		Current value	CN	00C5H			○	○	
		Link special relay	SB(*3)	00A1H	○	○			
		Link special register	SW(*3)	00B5H			○	○	
	Step relay	S	0098H	○	○				
Direct device	Direct input	DX	00A2H	○	○				
	Direct output	DY	00A3H	○	○				
Index register	Index register	Z	00CCH			○	○		
File register	File register	R	00AFH			○	○		
		ZR(*1)	00B0H					○	
QJ71MT91 buffer memory (*2)(*3)	User free area	—	F000H			○	○		

*1: The device assigned to the extended file register is fixed to the file register (ZR).

Refer to Section 7.4.4 for the extended file register.

*2: Refer to Section 7.4.5 for device assignment to the QJ71MT91 buffer memory.

*3: Only this device is supported when the QJ71MT91 is mounted on a MELSECNET/H remote I/O station. An error will occur if an access request is received from the MODBUS® /TCP master with any other device assigned.

*4: Corresponds to LB and LW on a MELSECNET/H remote I/O station.

*5: When setting with GX Configurator-MB, input the head device.

*6: The extended data register D65536 and higher area and extended link register W10000 and higher area cannot be allocated as input register or holding register.

Use file register (ZR) specification instead.

For file register (ZR) specification of extended data register or extended link register, refer to the QCPU User's Manual (Function Explanation, Program Fundamentals).

Use Read file record (FC: 20) or Write file record (FC: 21) in the above case.

(2) Head device number

As the head device number, set the head device number of the programmable controller CPU device memory or the head address of the QJ71MT91 buffer memory to be assigned to the MODBUS[®] device.

(3) Head MODBUS[®] device number (Head coil number/Head input number/Head input register number/Head holding register number)

(a) As the head MODBUS[®] device number, set the head number of the MODBUS[®] device of the assignment target QJ71MT91.

(b) Use the following expression to find the set value of the head MODBUS[®] device number.

Head MODBUS[®] device number = Last 5 digits of MODBUS[®] device number to be set - 1

Example: Set "5139" when the MODBUS[®] device number is 105140.

(c) The head MODBUS[®] device number must not be duplicated in assignment 1 to 16.

Set different head MODBUS[®] device numbers.

The slave function of the QJ71MT91 is inactive if any of the device number settings are duplicated.

(4) Assignment points

As the assignment points, set the device points of the programmable controller CPU device memory or QJ71MT91 buffer memory to be assigned to the MODBUS[®] device.

POINT
The QJ71MT91 sends an exception response to the master if the master requests access to a device outside the programmable controller CPU range or to outside the user free area of the QJ71MT91 buffer memory.

7.4.3 Default assignment parameters

As the MODBUS® device assignment parameters, default assignment parameters are available as initial values.

To use the default assignment parameters, Bit 1 of the communication condition setting (switch 2) of the intelligent function module switches must be set to OFF.

Refer to Section 6.6 for details of the intelligent function module switches.

The following shows how the MODBUS® devices are assigned by the MODBUS® device assignment parameters and the default assignment parameter values set to the QJ71MT91 buffer memory.

[Assignment of MODBUS® devices by default assignment parameters]

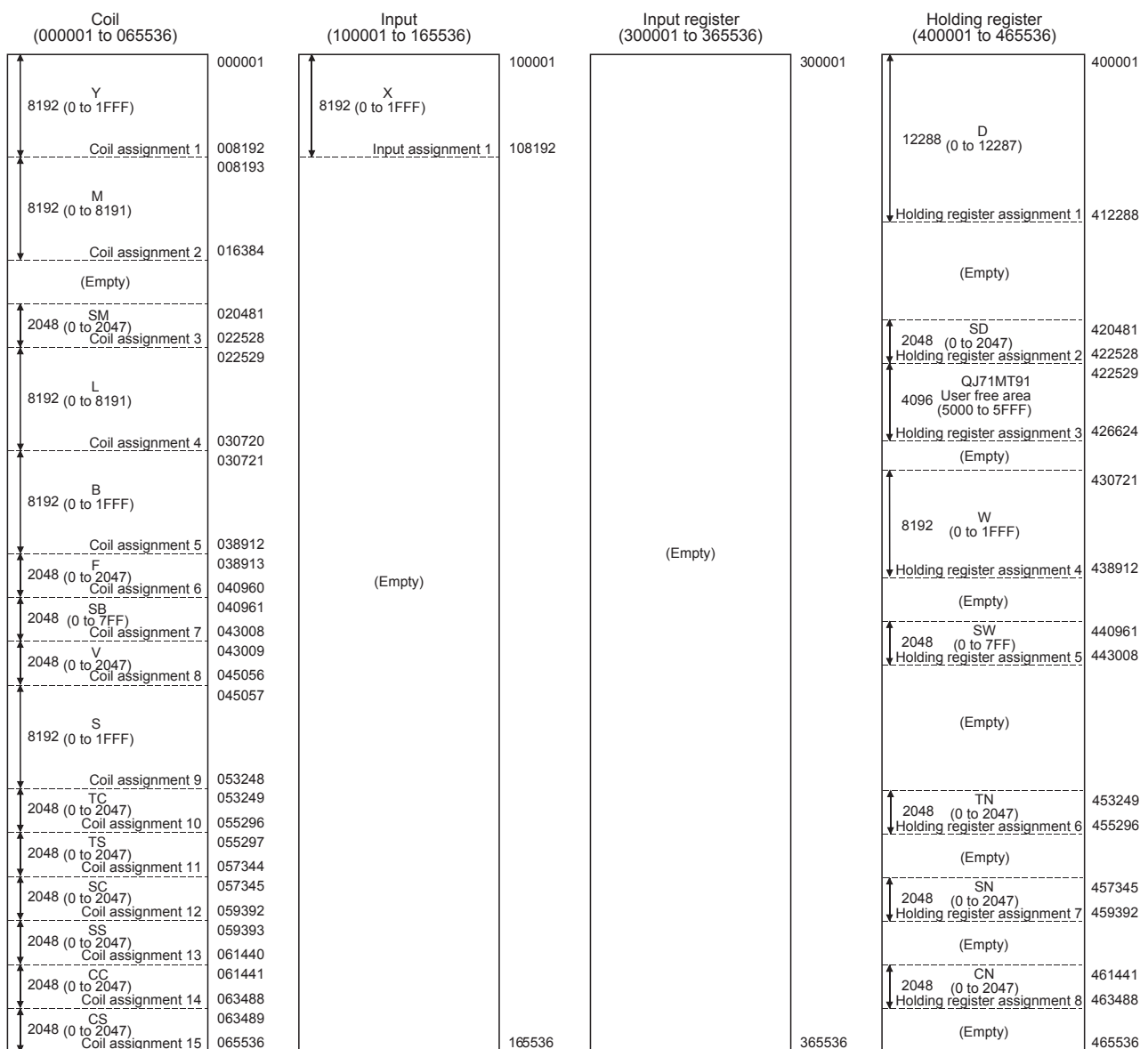

[Set values of default assignment parameters]

Assignment Name	Buffer Memory Address	Default Assignment Parameter Setting Items			
		Device code (Device symbol)	Head device number	Head MODBUS [®] device number (*1)	Assignment points
Coil assignment 1	0900H to 0903H	009DH (Y)	0000H	0	8192
Coil assignment 2	0904H to 0907H	0090H (M)	0000H	8192	8192
Coil assignment 3	0908H to 090BH	0091H (SM)	0000H	20480	2048
Coil assignment 4	090CH to 090FH	0092H (L)	0000H	22528	8192
Coil assignment 5	0910H to 0913H	00A0H (B)	0000H	30720	8192
Coil assignment 6	0914H to 0917H	0093H (F)	0000H	38912	2048
Coil assignment 7	0918H to 091BH	00A1H (SB)	0000H	40960	2048
Coil assignment 8	091CH to 091FH	0094H (V)	0000H	43008	2048
Coil assignment 9	0920H to 0923H	0098H (S)	0000H	45056	8192
Coil assignment 10	0924H to 0927H	00C0H (TC)	0000H	53248	2048
Coil assignment 11	0928H to 092BH	00C1H (TS)	0000H	55296	2048
Coil assignment 12	092CH to 092FH	00C6H (SC)	0000H	57344	2048
Coil assignment 13	0930H to 0933H	00C7H (SS)	0000H	59392	2048
Coil assignment 14	0934H to 0937H	00C3H (CC)	0000H	61440	2048
Coil assignment 15	0938H to 093BH	00C4H (CS)	0000H	63488	2048
Coil assignment 16	093CH to 093FH	0000H —	0000H	0	0
Input assignment 1	0940H to 0943H	009CH (X)	0000H	0	8192
Input assignment 2 to 16	0944H to 097FH	0000H —	0000H	0	0
Input register assignment 1 to 16	0980H to 09BFH	0000H —	0000H	0	0
Holding register assignment 1	09C0H to 09C3H	00A8H (D)	0000H	0	12288
Holding register assignment 2	09C4H to 09C7H	00A9H (SD)	0000H	20480	2048
Holding register assignment 3	09C8H to 09CBH	F000H —	5000H	22528	4096
Holding register assignment 4	09CCH to 09CFH	00B4H (W)	0000H	30720	8192
Holding register assignment 5	09D0H to 09D3H	00B5H (SW)	0000H	40960	2048
Holding register assignment 6	09D4H to 09D7H	00C2H (TN)	0000H	53248	2048
Holding register assignment 7	09D8H to 09DBH	00C8H (SN)	0000H	57344	2048
Holding register assignment 8	09DCH to 09DFH	00C5H (CN)	0000H	61440	2048
Holding register assignment 9 to 16	09E0H to 09FFH	0000H —	0000H	0	0

*1: Use the following expression to find the set value of the head MODBUS[®] device number.

Head MODBUS[®] device number = Last 5 digits of MODBUS[®] device number to be set - 1

POINT

The programmable controller CPU device range varies depending on the programmable controller CPU.

(Refer to QCPU User's Manual (Function Explanation, Program Fundamentals))

Depending on the programmable controller CPU, some of the default assignment parameter range may not be usable.

In such a case, observe either of the following not to access the devices outside the allowable range.

- Set the MODBUS[®] device assignment parameters. (Refer to Section 7.4)
Make the setting within the allowable programmable controller CPU device range.
- Do not access any device outside the allowable range when using the default assignment parameters.

7.4.4 MODBUS® extended file register assignment

(1) MODBUS® extended file register assignment

The MODBUS® extended file register assignment to the programmable controller CPU is fixed to the file register (ZR).

The MODBUS® extended file register is assigned to the file register (ZR) of the programmable controller CPU as shown below.

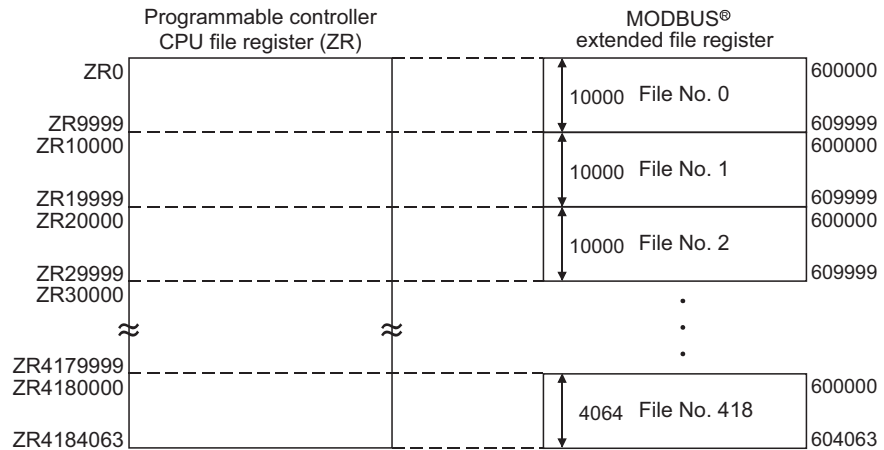

(2) Out-of-bounds read/write request

The QJ71MT91 sends an exception response when the master makes a request to the programmable controller CPU on the QJ71MT91-mounted station to read from or write to a nonexistent file register (ZR).

For the file register (ZR), refer to the QCPU user's manual (explanation, program fundamentals).

(3) MODBUS® extended file register size

The MODBUS® extended file register size depends on the file register (ZR) size set to the programmable controller CPU on the QJ71MT91-mounted station.

For details, refer to the QCPU user's manual (explanation, program fundamentals).

POINT

Even if the slave (QJ71MT91) receives Write File Record (FC: 21) when the programmable controller CPU's file register (ZR) is read-only (for example, when stored on a Flash card), it will issue a normal response. In this case, however, the action for Write File Record is not performed. To write to the extended file register, check that the programmable controller CPU's file register (ZR) is writable or not in advance.

7.4.5 QJ71MT91 buffer memory assignment

(1) QJ71MT91 buffer memory assignment

The QJ71MT91 can assign the MODBUS® devices to the QJ71MT91 buffer memory.

By making this assignment, access to the MODBUS® devices will not be influenced by the sequence scan.

This enables the QJ71MT91 to respond faster to the master.

(2) To assign the QJ71MT91 buffer memory to the MODBUS® device

(a) When using the MODBUS® device assignment parameter

When setting the MODBUS® device assignment parameter, set F000H for the device code. (Refer to Section 7.4.2)

(b) When using the default assignment parameter

Use any of the MODBUS® device, 422529 to 426624. (Refer to Section 7.4.3)

(3) MODBUS® device assignment range

The following QJ71MT91 buffer memory addresses can be assigned to the MODBUS® devices.

Buffer Memory Address	Size	Name	Auto Refresh Setting
5000H to 5FFFH	4096	User free area	Available

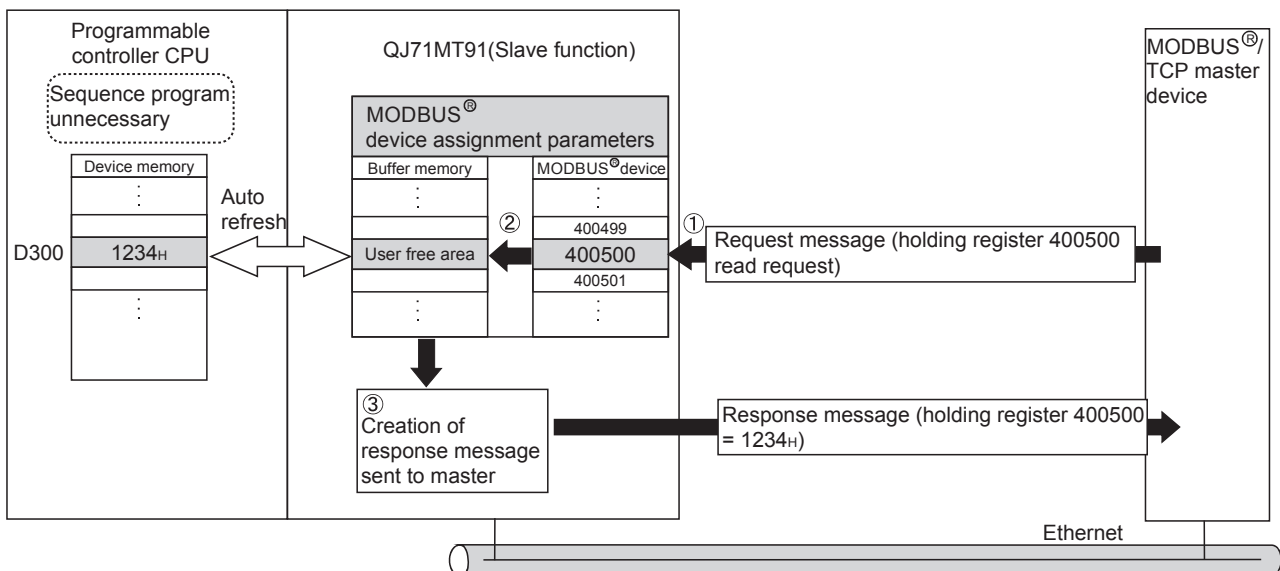

- 1) The QJ71MT91 receives a "holding register 400500 read" request message from the master.
- 2) The QJ71MT91 reads data from its own buffer memory according to the value set to the MODBUS® device assignment parameter.
Faster processing is executed as access is not influenced by the sequence scan.
- 3) The QJ71MT91 creates a response message and sends it to the master.

POINT

<p>The programmable controller CPU device memory value can be stored in the QJ71MT91 buffer memory, and the QJ71MT91 buffer memory value can be stored in the programmable controller CPU device memory.</p>
--

<p>Data can be stored by either of the following:</p>

- | |
|---|
| <ul style="list-style-type: none">▪ Automatic refresh setting on GX Configurator-MB (Refer to Section 8.5)▪ Transfer using intelligent function module devices (Un\G□) |
|---|

<p>(Refer to QCPU User's Manual (Function Explanation, Program Fundamentals))</p>

8 UTILITY PACKAGE (GX Configurator-MB)

GX Configurator-MB is a tool designed to support sequence program creation necessary for the parameter setting, auto refresh, and monitor/test of the QJ71MT91.

8.1 Functions of the Utility Package

The following table lists the GX Configurator-MB functions.

Item	Description	Reference section
Initial setting	(1) The following items that require initial setting. <ul style="list-style-type: none"> · Basic parameters · Automatic communication parameters · MODBUS[®] device assignment parameters (2) The initially set data are registered to the CPU module parameters, and automatically written to the QJ71MT91 when the CPU module enters the RUN status.	Section 8.4
Auto refresh setting	(1) The QJ71MT91's buffer memory is configured for automatic refresh. <ul style="list-style-type: none"> · Automatic communication function buffer input area · Automatic communication function buffer output area · Automatic communication operation status storage area · User free area (2) The data of the QJ71MT91 buffer memory areas set for auto refresh are automatically read from/written to the specified devices when the END instruction of the CPU module is executed.	Section 8.5
Monitor/test	(1) Monitor/test The buffer memory and I/O signals of the QJ71MT91 are monitored or tested. <ul style="list-style-type: none"> · Various setting status, module status · X/Y Monitor/test · Basic/MODBUS[®] device assignment parameter status · Automatic communication status · Error log · Communication status · PING test 	Section 8.6

8.2 Installing and Uninstalling the Utility Package

For how to install or uninstall the utility package, refer to "Method of installing the MELSOFT Series" included in the utility package.

8.2.1 Handling precautions

The following explains the precautions on using the GX Configurator-MB.

(1) For safety

Since GX Configurator-MB is add-in software for GX Developer, read "Safety Precautions" and the basic operating procedures in the GX Developer Operating Manual.

(2) About installation

GX Configurator-MB is add-in software for GX Developer Version 4 or later. Therefore, GX Configurator-MB must be installed on the personal computer that has already GX Developer Version 4 or later installed.

(3) Screen error of Intelligent function module utility

Insufficient system resource may cause the screen to be displayed inappropriately while using the Intelligent function module utility.

If this occurs, close the Intelligent function module utility, GX Developer (program, comments, etc.), and other applications, and then start GX Developer and Intelligent function module utility again.

(4) To start the Intelligent function module utility

(a) In GX Developer, select "QCPU (Q mode)" for PLC series and specify a project.

If any PLC series other than "QCPU (Q mode)" is selected, or if no project is specified, the Intelligent function module utility will not start.

(b) Multiple Intelligent function module utilities can be started.

However, [Open parameters] and [Save parameters] operations under [Intelligent function module parameter] are allowed for one Intelligent function module utility only. Only the [Monitor/test] operation is allowed for the other utilities.

(5) Switching between two or more Intelligent function module utilities

When two or more Intelligent function module utility screens cannot be displayed side by side, select a screen to be displayed on the top of others using the task bar.

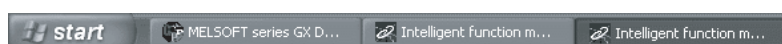

(6) Number of parameters that can be set in GX Configurator-MB

When multiple intelligent function modules are mounted, the number of parameter settings must not exceed the following limit.

When intelligent function modules are installed to:	Maximum number of parameter settings	
	Initial setting	Auto refresh setting
Q00J/Q00/Q01CPU	512	256
Q02/Q02H/Q06H/Q12H/Q25HCPU	512	256
Q02PH/Q06PH/Q12PH/Q25PHCPU	512	256
Q12PRH/Q25PRHCPU	512	256
Q00UJ/Q00U/Q01UCPU	512	256
Q02UCPU	2048	1024
Q03UD/Q04UDH/Q06UDH/ Q10UDH/Q13UDH/ Q20UDH/ Q26UDH/Q03UDE/Q04UDEH/ Q06UDEH/Q10UDEH/Q13UDEH/ Q20UDEH/Q26UDEHCPU	4096	2048
CPU modules other than the above	Not supported	Not supported
MELSECNET/H remote I/O station	512	256

For example, if multiple intelligent function modules are installed to the MELSECNET/H remote I/O station, configure the settings in GX Configurator so that the number of parameter settings for all the intelligent function modules does not exceed the limit of the MELSECNET/H remote I/O station.

Calculate the total number of parameter settings separately for the initial setting and for the auto refresh setting.

The number of parameters that can be set for one module in GX Configurator-MB is as shown below.

Target module	Initial setting	Auto refresh setting
QJ71MT91	3 (Fixed)	5 (Max.)

Example) Counting the number of parameter settings in Auto refresh setting

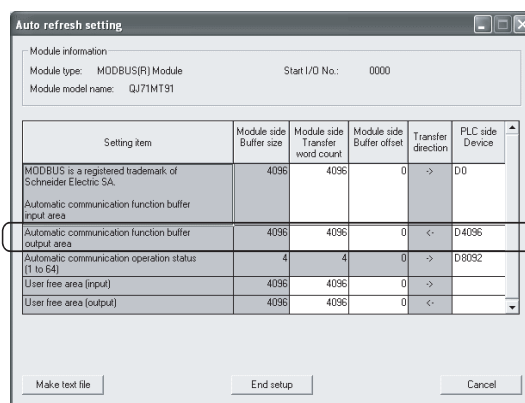

This one row is counted as one setting. Blank rows are not counted. Count up all the setting items on this screen, and add the total to the number of settings for other intelligent function modules to get a grand total.

8.2.2 Operating environment

This section describes the operating environment of the personal computer that runs GX Configurator-MB.

Item	Description
Installation (add-in) target *1	GX Developer Version 4 (English version) or later. *2 *4
Personal computer	Personal computer running one of the following operating systems
CPU	Refer to the next page "Operating system and performance required for personal computer".
Required memory	
Available hard disk capacity	For installation
	For operation
Monitor	Resolution 800 × 600 pixels or higher *3
Operating system	Microsoft® Windows® 95 Operating System (English version) Microsoft® Windows® 98 Operating System (English version) Microsoft® Windows® Millennium Edition Operating System (English version) Microsoft® Windows NT® Workstation Operating System Version 4.0 (English version) Microsoft® Windows® 2000 Professional Operating System (English version) Microsoft® Windows® XP Professional Operating System (English version) Microsoft® Windows® XP Home Edition Operating System (English version) Microsoft® Windows Vista® Home Basic Operating System (English version) Microsoft® Windows Vista® Home Premium Operating System (English version) Microsoft® Windows Vista® Business Operating System (English version) Microsoft® Windows Vista® Ultimate Operating System (English version) Microsoft® Windows Vista® Enterprise Operating System (English version) Microsoft® Windows® 7 Starter Operating System (English version) *4 Microsoft® Windows® 7 Home Premium Operating System (English version) *4 Microsoft® Windows® 7 Professional Operating System (English version) *4 Microsoft® Windows® 7 Ultimate Operating System (English version) *4 Microsoft® Windows® 7 Enterprise Operating System (English version) *4

*1: Install GX Configurator-MB in GX Developer Version 4 or later in the same language.

GX Developer (English version) and GX Configurator-MB (Japanese version) or GX Developer (Japanese version) and GX Configurator-MB (English version) cannot be used in combination.

*2: GX Configurator-MB is not applicable to GX Developer Version 3 or earlier.

*3: The recommended resolution is 1024 × 768 pixels or higher for Windows Vista® and Windows® 7.

*4: For 32-bit Windows® 7, install GX Configurator-MB Version 1.09K or later as an add-in to GX Developer Version 8.91V or later.

For 64-bit Windows® 7, install GX Configurator-MB Version 1.09K or later as an add-in to GX Developer Version 8.98C or later.

Operating system and performance required for a personal computer

Operating system	Performance required for a personal computer	
	CPU	Required memory
Windows® 95	Pentium® 133MHz or more	32MB or more
Windows® 98	Pentium® 133MHz or more	32MB or more
Windows® Me	Pentium® 150MHz or more	32MB or more
Windows NT® Workstation 4.0	Pentium® 133MHz or more	32MB or more
Windows® 2000 Professional	Pentium® 133MHz or more	64MB or more
Windows® XP	Pentium® 300MHz or more	128MB or more
Windows Vista®	Pentium® 1GHz or more	1GB or more
Windows® 7	Pentium® 1GHz or more	1GB or more (32-bit version) 2GB or more (64-bit version)

POINT





- The following functions cannot be used when the computer is running under Windows® XP, Windows Vista®, or Windows® 7. This product may not perform properly, when these functions are used.
 - Activating the application with Windows® compatible mode
 - Simplified user switch-over
 - Remote desktop
 - Large font size (Advanced setting of Display Properties)
 - DPI setting other than 100%
 - 64-bit version * 1
 - Windows XP Mode
 - Windows Touch
- * 1: Supported by Windows® 7.
- Use the product as a user having a privilege higher than "USER" for Microsoft® Windows Vista® .

8.3 Utility Package Operation

8.3.1 Common utility package operations

(1) Control keys

Special keys that can be used for operation of the utility package and their applications are shown in the table below.

Key	Application
Esc	<p>Cancels the current entry in a cell.</p> <p>Closes the window.</p>
Tab	Moves between controls in the window.
Ctrl	Used in combination with the mouse operation to select multiple cells for test execution.
Delete	<p>Deletes the character where the cursor is positioned.</p> <p>When a cell is selected, clears all of the setting contents in the cell.</p>
Back Space	Deletes the character where the cursor is positioned.
   	Moves the cursor.
Page Up	Moves the cursor one page up.
Page Down	Moves the cursor one page down.
Enter	Completes the entry in the cell.

(2) Data created with the utility package

The following data or files that are created with the utility package can be also handled in GX Developer. Figure 8.1 shows respective data or files are handled in which operation.

<Intelligent function module parameter>

- (a) Initial settings and auto refresh settings are saved in an intelligent function module parameter file in a project created with GX Developer.

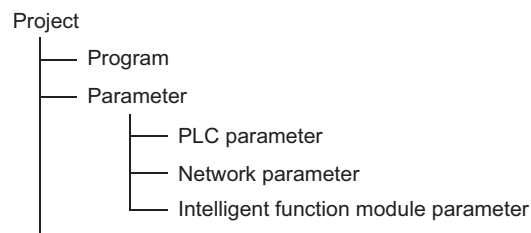

- (b) Steps 1) to 3) shown in Figure 8.1 are performed as follows:

- 1) From GX Developer, select:

[Project] → [Open project]/[Save]/[Save as]

- 2) On the intelligent function module selection screen of the utility, select:

[Intelligent function module parameter] → [Open parameters]/[Save parameters]

- 3) From GX Developer, select:

[Online] → [Read from PLC]/[Write to PLC] → "Intelligent function module parameter"

Alternatively, from the intelligent function module selection screen of the utility, select:

[Online] → [Read from PLC]/[Write to PLC]

<Text files>

A text file can be created by clicking the **Make text file** button on the initial setting, Auto refresh setting, or Monitor/Test screen.
 The text files can be utilized to create user documents.

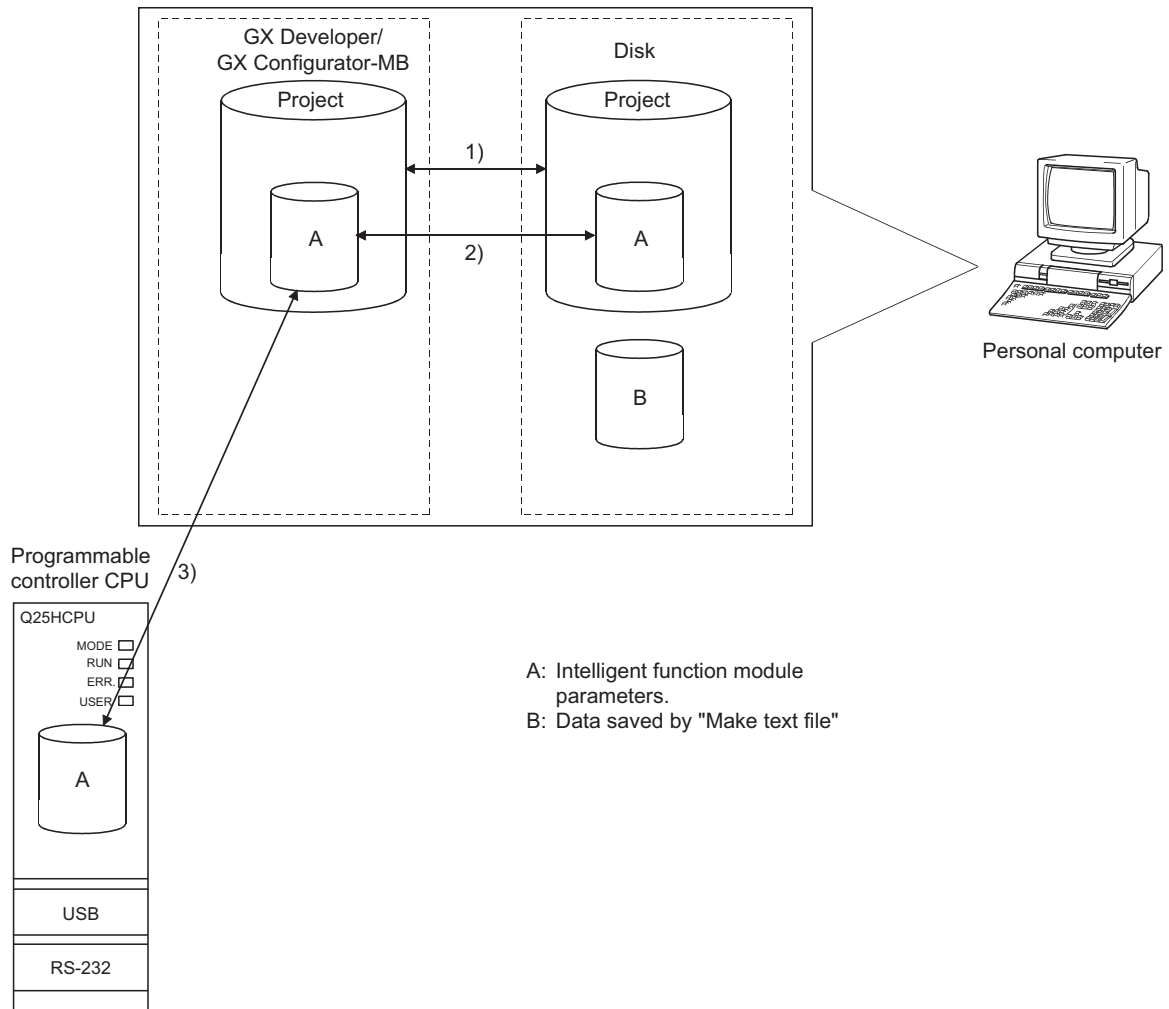
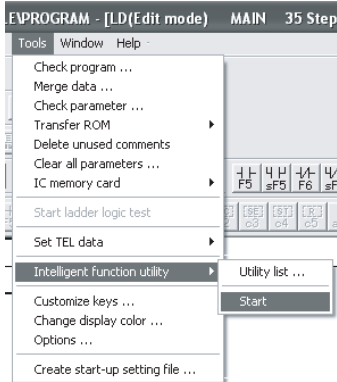

Figure 8.1 Correlation chart for data created with the utility package

8.3.2 Operation overview

GX Developer screen



↓ [Tools] - [Intelligent function utility] - [Start]

Select a target intelligent function module screen

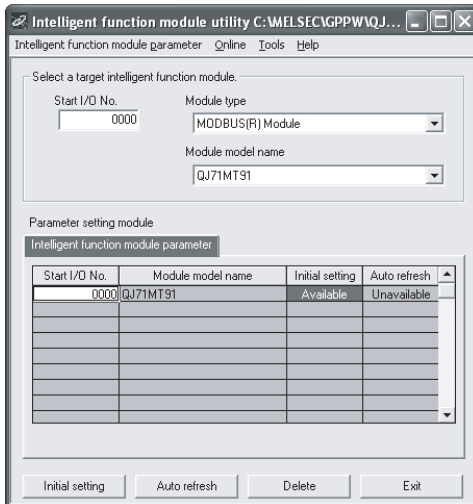

Enter "Start I/O No." and select "Module type" and "Module model name".

Refer to Section 8.3.3

Initial setting

Auto refresh

Initial setting screen

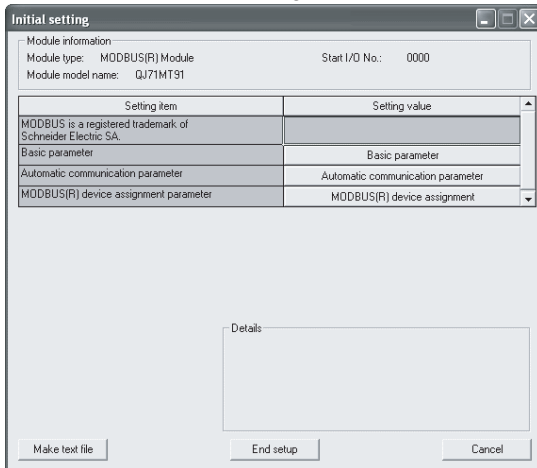

Refer to Section 8.4

Auto refresh setting screen

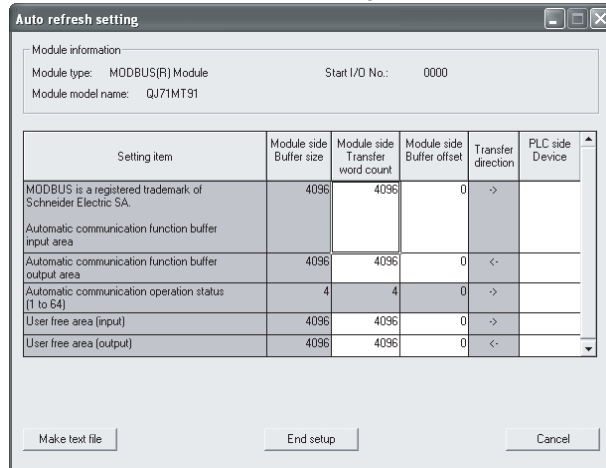

Refer to Section 8.5

1) [Online] - [Monitor/Test]

Select monitor/test module screen

Select monitor/test module

Select monitor/test module

Start I/O No. 0000 Module type MODBUS(R) Module

Module model name QJ71MT91

Module implementation status

Start I/O No.	Module model name
0000	QJ71MT91

Monitor/Test Exit

Select the module to be monitored/tested.

Monitor/Test screen

Monitor/Test

Module information

Module type: MODBUS(R) Module Start I/O No.: 0000

Module model name: QJ71MT91

Setting item	Current value	Setting value
MODBUS is a registered trademark of Schneider Electric SA.		
Switch 1: Operation mode setting status	Online	
Switch 2: Communication condition setting status	Default parameter	
Basic parameter starting method		
MODBUS(R) device assignment parameter starting method	Default parameter	
Online change enable/disable	Disable	
Send frame specification	Ethernet(V2.0)	
Switch 3.4: Local station IP address setting status	192.1.0.254	
Module READY	Accessible	

Flash ROM setting

Write to module Save file Current value display

Read from module Load file Make text file

Details

Monitoring

Cannot execute test

Start monitor Stop monitor Execute test Close

Refer to Section 8.6

8.3.3 Starting the Intelligent function module utility

[Operating procedure]

Intelligent function module utility is started from GX Developer.

[Tools] → [Intelligent function utility] → [Start]

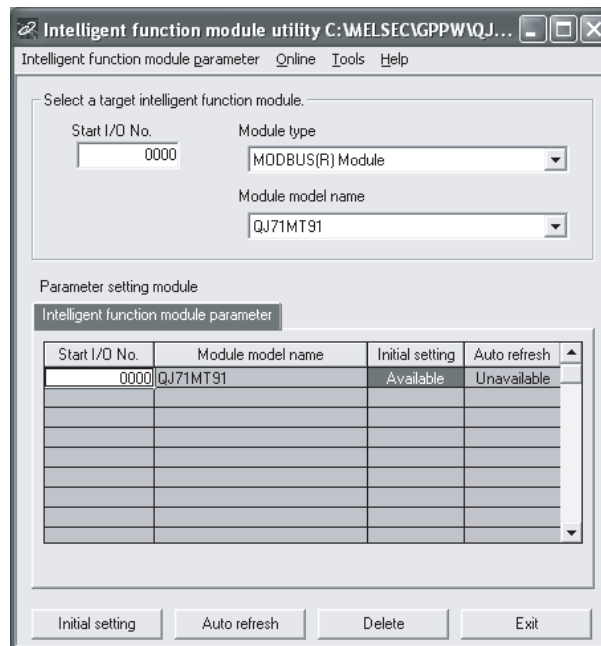
[Setting Screen]**[Explanation of items]****(1) Activation of other screens**

Following screens can be displayed from the intelligent function module utility screen.

(a) Initial setting screen

"Start I/O No." *1 → "Module type" → "Module model name" →

Initial setting

(b) Auto refresh setting screen

"Start I/O No." *1 → "Module type" → "Module model name" →

Auto refresh

(c) Select monitor/test module screen

[Online] → [Monitor/Test]

*1: Enter the start I/O No. in hexadecimal.

(2) Command buttons

Delete Deletes the initial setting and auto refresh setting of the selected module.

Exit Closes this screen.

(a) File menu

Intelligent function module parameters of the project opened by GX Developer are handled.

[Open parameters] : Reads a parameter file.

[Close parameters] : Closes the parameter file. If any data are modified, a dialog asking for file saving will appear.

[Save parameters] : Saves the parameter file.

[Delete parameters] : Deletes the parameter file.

[Exit] : Closes this screen.

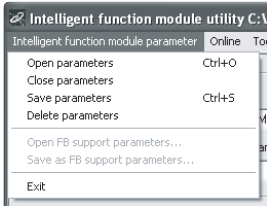

(b) Online menu

[Monitor/Test] : Activates the Select monitor/test module screen.

[Read from PLC] : Reads intelligent function module parameters from the CPU module.

[Write to PLC] : Writes intelligent function module parameters to the CPU module.

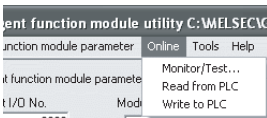

POINT

(1) Saving intelligent function module parameters in a file

Since intelligent function module parameters cannot be saved in a file by the project saving operation of GX Developer, save them on the shown module selection screen.

(2) Reading/writing intelligent function module parameters from/to a programmable controller using GX Developer

(a) Intelligent function module parameters can be read from and written into a programmable controller after having been saved in a file.

(b) Set a target programmable controller CPU in GX Developer

[Online] → [Transfer Setup]

Only use the control CPU for the QJ71MT91 to write the intelligent function module parameters for a multiple CPU system to the programmable controller.

(c) When the QJ71MT91 is mounted on a MELSECNET/H remote I/O station, [Read from PLC] and [Write to PLC] must be performed from GX Developer.

(3) Checking the required utility

While the start I/O is displayed on the Intelligent function module utility setting screen, "*" may be displayed for the model name.

This means that the required utility has not been installed or the utility cannot be started from GX Developer.

Check the required utility, selecting [Tools] - [Intelligent function utility] - [Utility list...] in GX Developer.

8.4 Initial Setting

[Purpose]

Set parameters on the initial setting screen.

This setting eliminates the need for parameter setting by sequence programs.

The initial setting are as follows.

- Basic parameters
- Automatic communication parameters
- MODBUS® device assignment parameters

[Operating procedure]

"Start I/O No." → "Module type" → "Module model name" → **Initial setting**

[Setting Screen]

Setting item	Setting value
MODBUS is a registered trademark of Schneider Electric SA.	
Basic parameter	Basic parameter
Automatic communication parameter	Automatic communication parameter
MODBUS(R) device assignment parameter	MODBUS(R) device assignment

[Explanation of items]**(1) Parameter settings**

Select a button under the Setting value, and set the parameters on the corresponding screen.

- Basic parameter setting (refer to Section 8.7.1)
- Automatic communication parameter setting (refer to Section 8.7.2)
- MODBUS® device assignment parameter setting (refer to Section 8.7.3)

(2) Command buttons

- | | |
|-----------------------|--|
| Make text file | Creates a file containing the screen data in text file format. |
| End setup | Saves the set data and ends the operation. |
| Cancel | Cancels the setting and ends the operation. |

POINT
<p>(1) When parameters are set on the initial setting screen, Basic parameter setting existence (X3) turns on after the programmable controller CPU is in RUN status.</p> <p>(2) The initial settings are stored as the intelligent function module parameters. After the intelligent function module parameters have been written to the programmable controller CPU, the initial setting is updated when the programmable controller is powered ON from OFF or the programmable controller CPU is reset (with the programmable controller CPU's RUN/STOP switch set to RUN). If the QJ71MT91 is mounted on a MELSECNET/H remote I/O station, the initial settings become effective when the remote I/O station receives the information notifying the status change (from STOP to RUN) of the remote master station's programmable controller CPU. At this time, do not write data to the buffer memory using a sequence program and do not manipulate Y-signals until Basic parameter setting existence (X) turns on.</p> <p>(3) If the initial setting data are written using a sequence program, the initial setting values are written when the CPU module switches from STOP to RUN status. Therefore, perform programming so that the initial setting will be re-executed in the sequence program.</p> <p>(4) The parameter setting by sequence program has priority over the parameter setting by initial setting when both of them are used.</p>

8.5 Auto Refresh Setting

[Purpose]

Make this setting to store the QJ71MT91 buffer memory data into the specified devices of the programmable controller CPU or to store the programmable controller CPU device data into the QJ71MT91 buffer memory automatically.

[Operating procedure]

"Start I/O No." → "Module type" → "Module model name" → Auto refresh

[Setting screen]

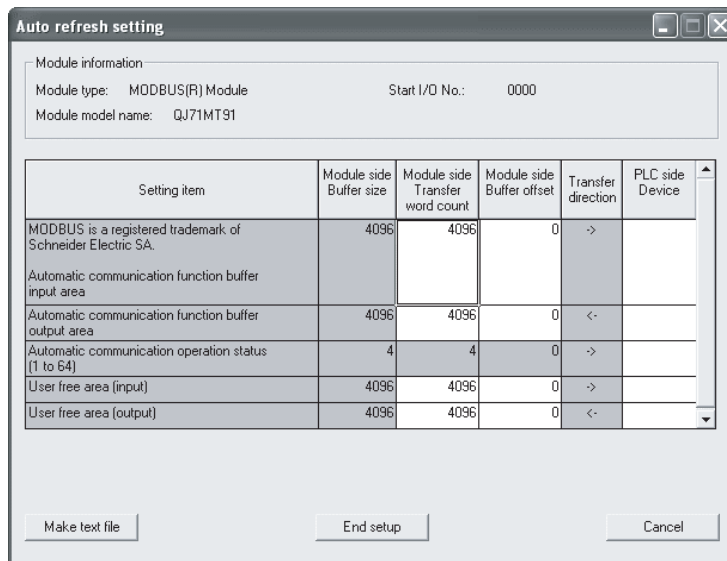

[Explanation of items]

(1) Display data

(a) Setting items

Setting Item	Buffer memory address	Reference section
Automatic communication function buffer input area	4096 to 8191 (1000H to 1FFFH)	Section 5.2.1
Automatic communication function buffer output area	12288 to 16383 (3000H to 3FFFH)	
Automatic communication operation status (1 to 64)	3104 to 3107 (0C20H to 0C23H)	
User free area (input/output)	20480 to 24575 (5000H to 5FFFH)	Section 7.4.5

(b) Display items

1) Module side Buffer size

Displays the buffer memory size of the setting item.

2) Module side Transfer word count

Displays the number of words to be transferred.

3) Module side buffer offset

Displays the offset value of the buffer memory data to be transferred.

4) Transfer direction

"< -" indicates that data are written from the device to the buffer memory.

"- >" indicates that data are load from the buffer memory to the device.

5) PLC side Device

Enter a CPU module side device that is to be automatically refreshed.

Applicable devices are X, Y, M, L, B, T, C, ST, D, W, R and ZR.

When using bit devices X, Y, M, L or B, set a number that can be divided by 16 points (examples: X10, Y120, M16, etc.).

Also, buffer memory data are stored in a 16-point area, starting from the specified device number. For example, if X10 is entered, data are stored in X10 to X1F.

The devices available for MELSECNET/H remote I/O modules are X, Y, M, B, D and W.

(2) Command buttons

Creates a file containing the screen data in text file format.

Saves the set data and ends the operation.

Cancels the setting and ends the operation.

POINT

- (1) The auto refresh settings are stored in an intelligent function module parameter file.

After the intelligent function module parameters have been written to the programmable controller CPU, the automatic refresh setting is updated when the programmable controller is powered ON from OFF or the programmable controller CPU is reset (with the programmable controller CPU's RUN/STOP switch set to RUN).

- (2) The auto refresh settings cannot be changed from the sequence programs. However, processing equivalent to auto refresh can be added using the FROM/TO instruction in the sequence program.

8.6 Monitor/Test

[Monitor/Test Purpose]

From this screen, start the monitoring or test of the operating status, I/O signals, parameter setting status, automatic communication status, error log, communication status of the QJ71MT91 and perform PING test.

[Operating procedure]

Select monitor/test module screen → "Start I/O No. *" → "Module type" → "Module model name" → Monitor/Test

*: Enter the start I/O No. in hexadecimal.

The screen can also be started from System monitor of GX Developer Version 6 or later.

Refer to the GX Developer Operating Manual for details.

[Monitor/Test Screen]

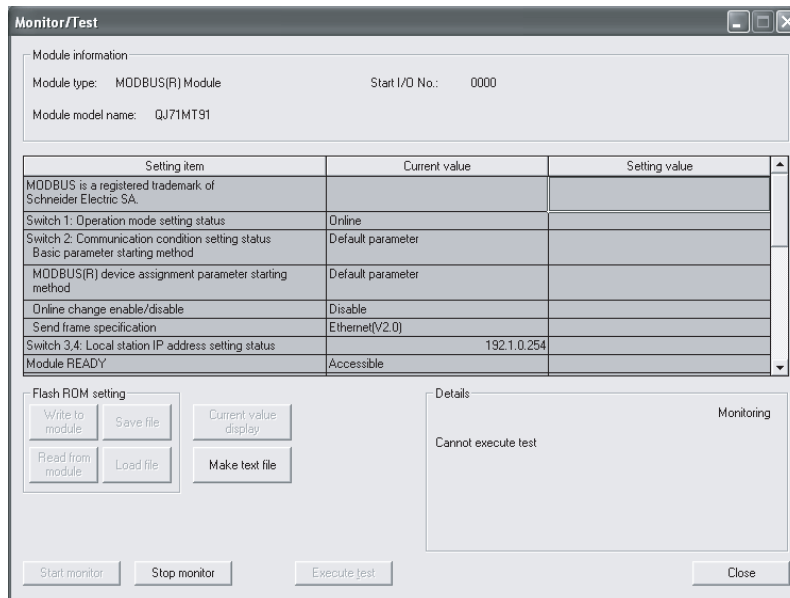

[Monitor/Test Items]

Monitor/Test Items			Buffer memory address	Reference section
Intelligent function module switch setting status (*3)	Switch 1	Operation mode setting status	0C00H (3072)	Section 6.6
	Switch 2	Communication condition setting status	Basic parameter starting method	
			MODBUS® device assignment parameter starting method	
			Online change enable/disable	
Switch 3, 4	Local station IP address setting status	0C02H to 0C03H (3074 to 3075)		
Module READY			—	Section 11.1
Watch dog timer error			—	

Monitor/Test Items		Buffer memory address	Reference section	
Module status	LED ON status	INIT. status	0C05 _H (3077)	Section 11.2
		OPEN status		
		ERR. status		
		COM. ERR. status		
COM. ERR. LED OFF request (*1)		—	Section 11.4.1	
X/Y Monitor/test (*2)		—	Section 8.6.1	
Basic/MODBUS [®] device assignment parameter status (*2)		—	Section 8.6.2	
Automatic communication status (*2)		—	Section 8.6.3	
Error log (*2)		—	Section 8.6.4	
Communication status (*2)		—	Section 8.6.5	
PING test (*2)		—	Section 8.6.6	

*1: For the COM. ERR. OFF request, select the corresponding request in the Setting value column.

Refer to Section 11.4.1 for details.

*2: To move to each sub screen, click the button in the Setting value column.

*3: The switch 5 cannot be checked in Monitor/Test screen.

[Specifications common to Monitor and Test screens (including sub screens)]

The following explains the specifications common to respective screens.

(1) Display data

Setting item : Displays I/O signals and buffer memory names.

Current value : Monitors the I/O signal states and present buffer memory values.

Setting value : Enter or select the data to be written by test operation.

(2) Command buttons

Displays the current value of the item selected.
(This is used to check the text that cannot be displayed in the current value field. However, in this utility package, all items can be displayed in the display fields).

Creates a file containing the screen data in text file format.

/

Selects whether or not to monitor current values.

Performs a test on the selected items. To select more than one item, select them while holding down the key.

Closes the screen that is currently open and returns to the previous screen.

[Monitor/Test screen - Sub screen group shift]

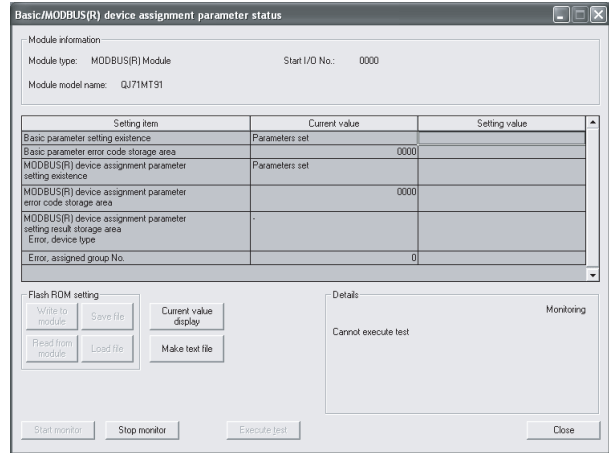
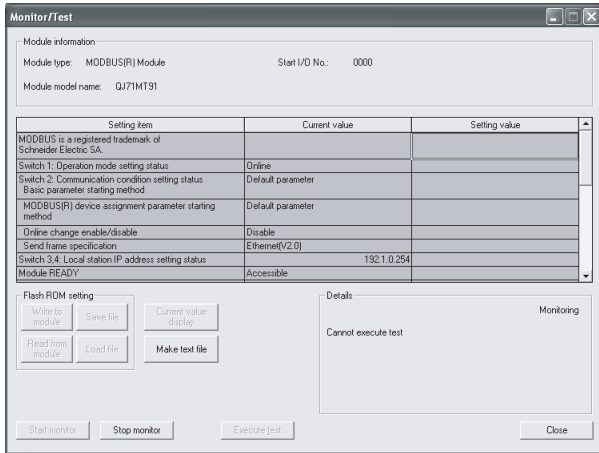

Refer to Section 8.6.2

Basic/MODBUS(R) device

1)

X/Y Monitor/test

Automatic communication

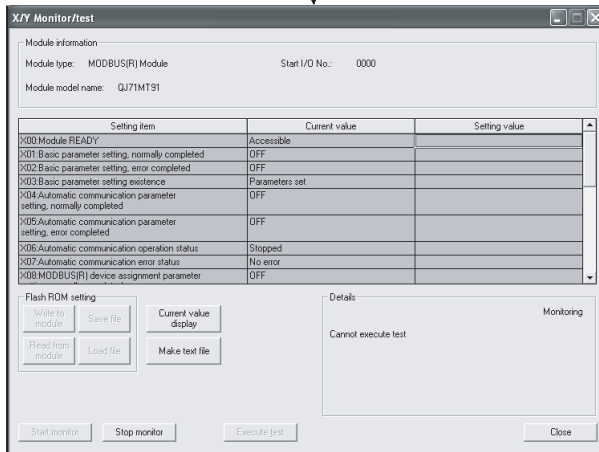

Refer to Section 8.6.1

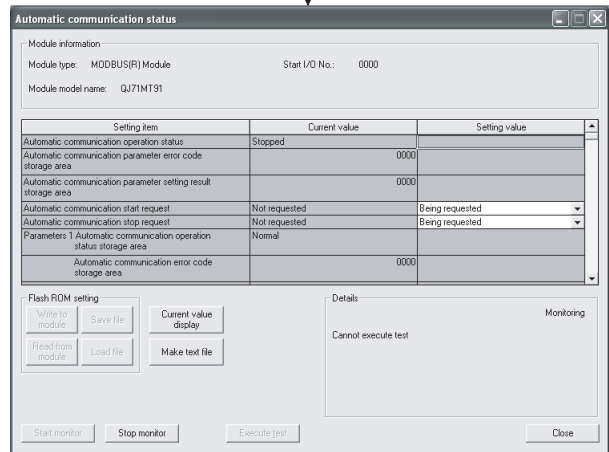

Refer to Section 8.6.3

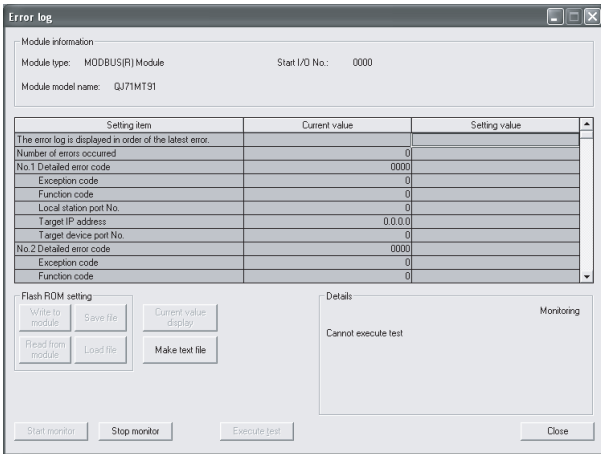

Refer to Section 8.6.4

Error log

1)

Communication status

PING test

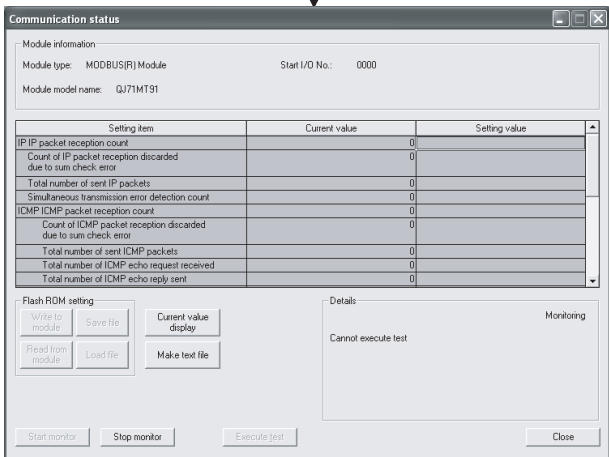

Refer to Section 8.6.5

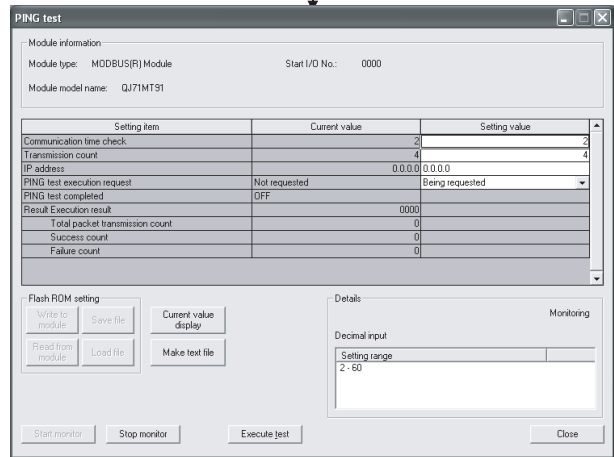

Refer to Section 8.6.6

8.6.1 X/Y Monitor/test

[Monitor/Test Purpose]

Monitor I/O signals and performs tests on output signals.

[Operating procedure]

Monitor/Test screen → X/Y Monitor/test

[Monitor/Test Screen]

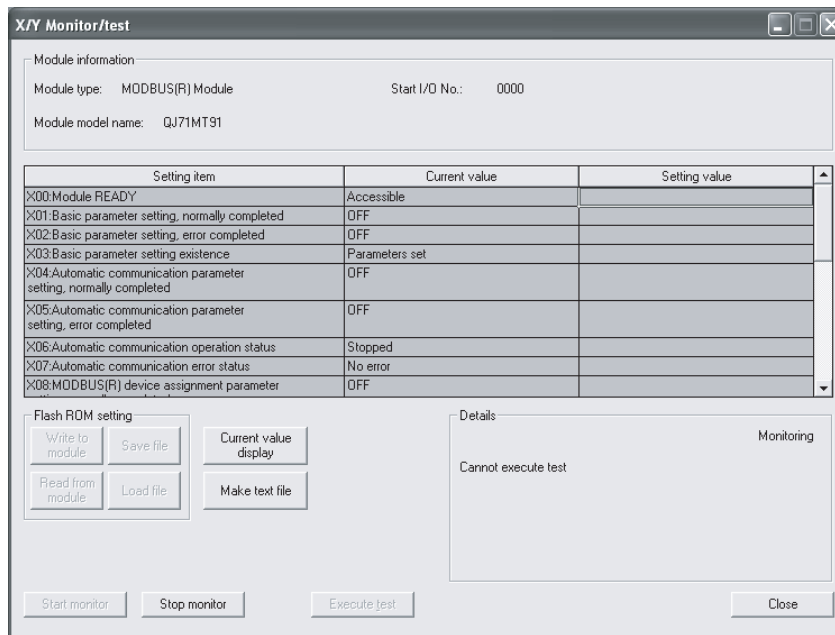

[Monitor/Test Items]

(1) X: Input signals

Monitor/Test Item	Buffer memory address	Reference section
X00: Module READY	—	Section 3.2.1
X01: Basic parameter setting, normally completed	—	
X02: Basic parameter setting, error completed	—	
X03: Basic parameter setting existence	—	
X04: Automatic communication parameter setting, normally completed	—	
X05: Automatic communication parameter setting, error completed	—	
X06: Automatic communication operation status	—	
X07: Automatic communication error status	—	
X08: MODBUS® device assignment parameter setting, normally completed	—	
X09: MODBUS® device assignment parameter setting, error completed	—	
X0A: MODBUS® device assignment parameter setting existence	—	
X1B: COM. ERR. LED status	—	
X1C: PING test completed	—	
X1F: Watch dog timer error	—	

(2) Y: Output signals

To perform a test on output signals, select any item in the Setting value column and click the button.

Monitor/Test Item	Buffer memory address	Reference section
Y01: Basic parameter setting request	—	Section 3.2.1
Y04: Automatic communication parameter setting request/automatic communication start request	—	
Y06: Automatic communication stop request	—	
Y08: MODBUS [®] device assignment parameter setting request	—	
Y1B: COM. ERR. LED OFF request	—	
Y1C: PING test execution request	—	

8.6.2 Basic/MODBUS® device assignment parameter status

[Monitor Purpose]

Monitor the setting status of the basic parameters and MODBUS® device assignment parameters.

[Operating procedure]

Monitor/Test screen → Basic/MODBUS(R) device

[Monitor Screen]

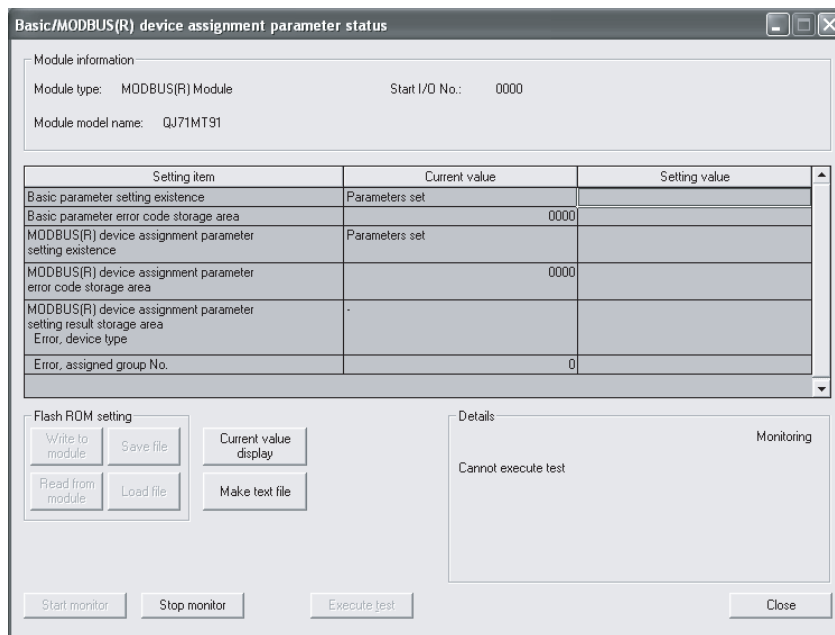

[Monitor Items]

Monitor Item	Buffer memory address	Reference section
Basic parameter setting existence	—	Section 11.3.1
Basic parameter error code storage area	0C10H (3088)	
MODBUS® device assignment parameter setting existence	—	
MODBUS® device assignment parameter error code storage area	0C13H (3091)	
MODBUS® device assignment parameter setting result storage area	Error, device type 0C14H (3092)	
	Error, assigned group No. 0C15H (3093)	

8.6.3 Automatic communication status

[Monitor/Test Purpose]

Monitor the communication status of the automatic communication function.

[Operating procedure]

[Monitor/Test] screen → [Automatic communication]

[Monitor/Test Screen]

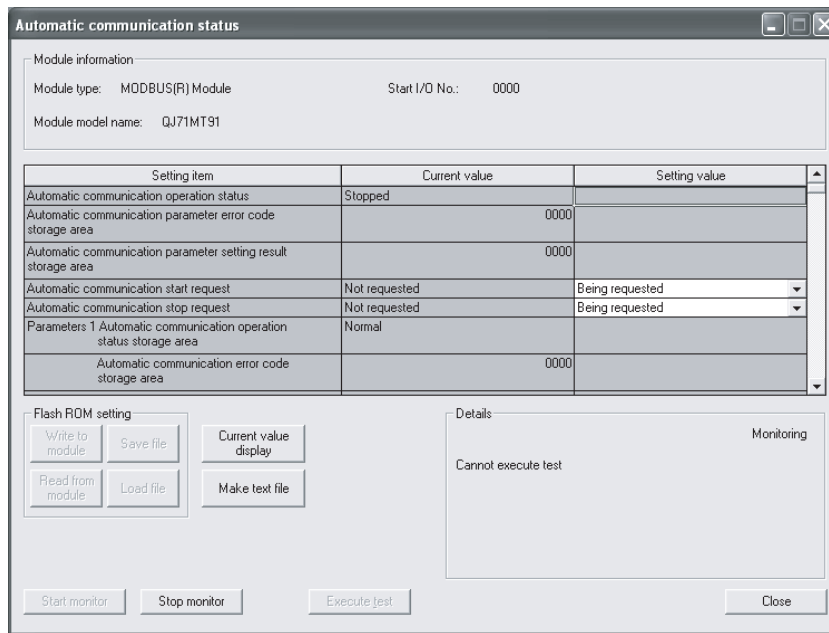

[Monitor/Test Items]

Monitor/Test Item		Buffer memory address	Reference section
Automatic communication operation status		—	Section 5.2.1
Automatic communication parameter error code storage area		0C11H (3089)	Section 11.3.1
Automatic communication parameter setting result storage area		0C12H (3090)	
Automatic communication start request (*1)		—	This section
Automatic communication stop request (*1)		—	
Parameter 1 to 64	Automatic communication operation status storage area	0C20H to 0C23H (3104 to 3107)	Section 11.3.1
	Automatic communication error code storage area	0C28H to 0C67H (3112 to 3175)	

*1: To test the automatic communication start request or automatic communication stop request, select the corresponding item in the Setting value column and click the button.

POINT
When conducting a test on the automatic communication start request or automatic communication stop request with "Being requested" set in the Setting value column, make sure that "Not requested" is displayed in the Current value column. When the current value is "Being requested", the test for "Being requested" setting cannot be performed. If the current value is "Being requested", change it to "Not requested" and start the test.

8.6.4 Error log

[Monitor Purpose]

Display the errors that occurred in the QJ71MT91.

Error logs are displayed in reverse chronological order (the latest error is displayed as No.1).

For details of the monitoring items, refer to Section 11.3.1 (8), (b) Number of error occurred and (d) Error log (error log 1 to 32).

[Operating procedure]

Monitor/Test screen → Error log

[Monitor Screen]

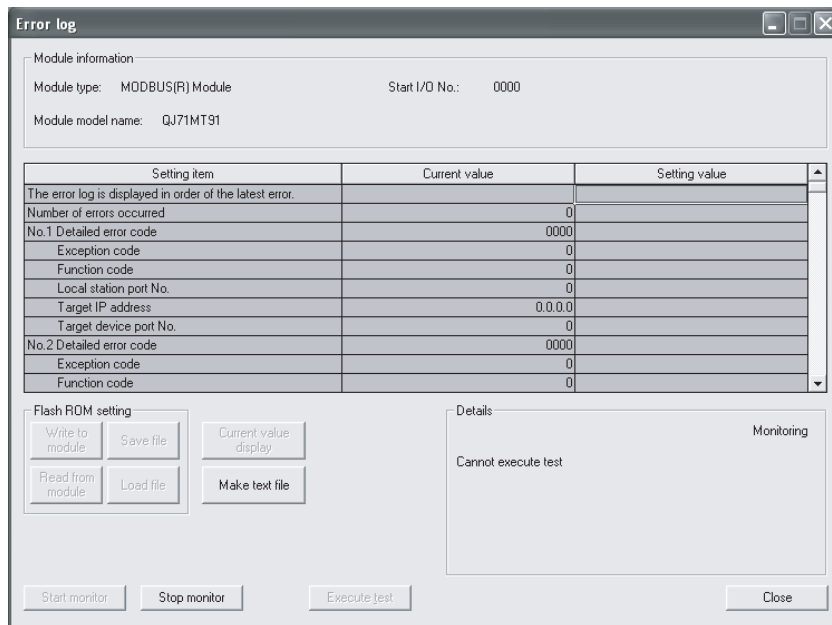

[Monitor Items]

Monitor Item		Buffer memory address	Reference section
Number of errors occurred		0CFEH (3326)	Section 11.3.1
Error log 1 to 32	Detailed error code	0D00H to 0DFFH (3328 to 3583)	
	Exception code		
	Function code		
	Local station port No.		
	Target IP address		
	Target device port No.		

8.6.5 Communication status

[Monitor Purpose]

Monitor the communication status by communication protocol.

[Operating procedure]

Monitor/Test screen → Communication status

[Monitor Screen]

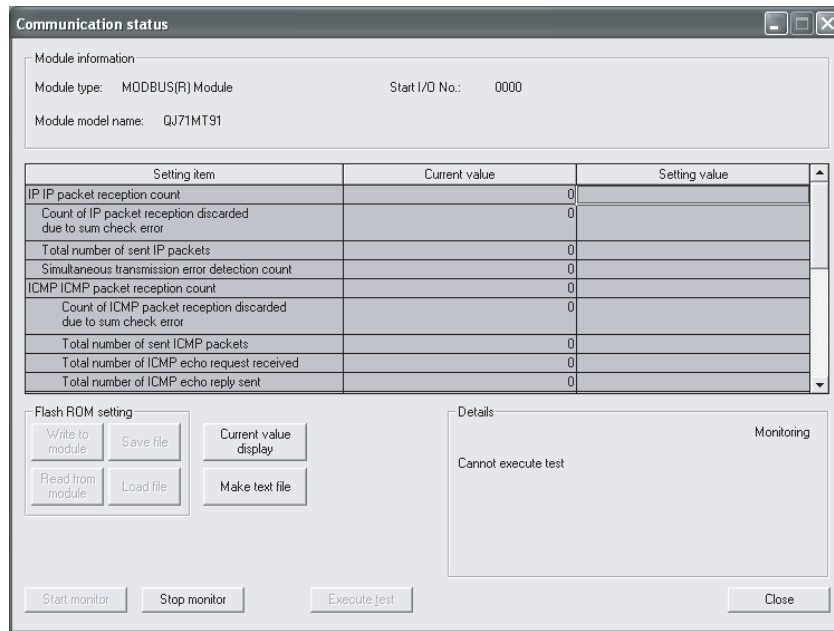

[Monitor Items]

Monitor Item		Buffer memory address	Reference section
IP	IP packet reception count	0E10H to 0E11H (3600 to 3601)	Section 11.3.1
	Count of IP packet reception discarded due to sum check error	0E12H to 0E13H (3602 to 3603)	
	Total number of sent IP packets	0E14H to 0E15H (3604 to 3605)	
	Simultaneous transmission error detection count	0E2AH to 0E2BH (3626 to 3627)	

Monitor Item		Buffer memory address	Reference section
ICMP	ICMP packet reception count	0E30H to 0E31H (3632 to 3633)	Section 11.3.1
	Count of ICMP packet reception discarded due to sum check error	0E32H to 0E33H (3634 to 3635)	
	Total number of sent ICMP packets	0E34H to 0E35H (3636 to 3637)	
	Total number of ICMP echo request received	0E36H to 0E37H (3638 to 3639)	
	Total number of ICMP echo reply sent	0E38H to 0E39H (3640 to 3641)	
	Total number of ICMP echo request sent	0E3AH to 0E3BH (3642 to 3643)	
	Total number of ICMP echo reply received	0E3CH to 0E3DH (3644 to 3645)	
TCP	TCP packet reception count	0E50H to 0E51H (3664 to 3665)	
	Count of TCP packet reception discarded due to sum check error	0E52H to 0E53H (3666 to 3667)	
	Total number of sent TCP packets	0E54H to 0E55H (3668 to 3669)	
UDP	UDP packet reception count	0E70H to 0E71H (3696 to 3697)	
	Count of UDP packet reception discarded due to sum check error	0E72H to 0E73H (3698 to 3699)	
	Total number of sent UDP packets	0E74H to 0E75H (3700 to 3701)	
Receive error	Framing error count	0E84H to 0E85H (3716 to 3717)	
	Overflow count	0E86H to 0E87H (3718 to 3719)	
	CRC error count	0E88H to 0E89H (3720 to 3721)	

8.6.6 PING test

[Monitor/Test Purpose]

Display the execution and result of a PING test.
Refer to Section 11.5 for details.

[Operating procedure]

[Monitor/Test] screen → [PING test]

[Monitor/Test Screen]

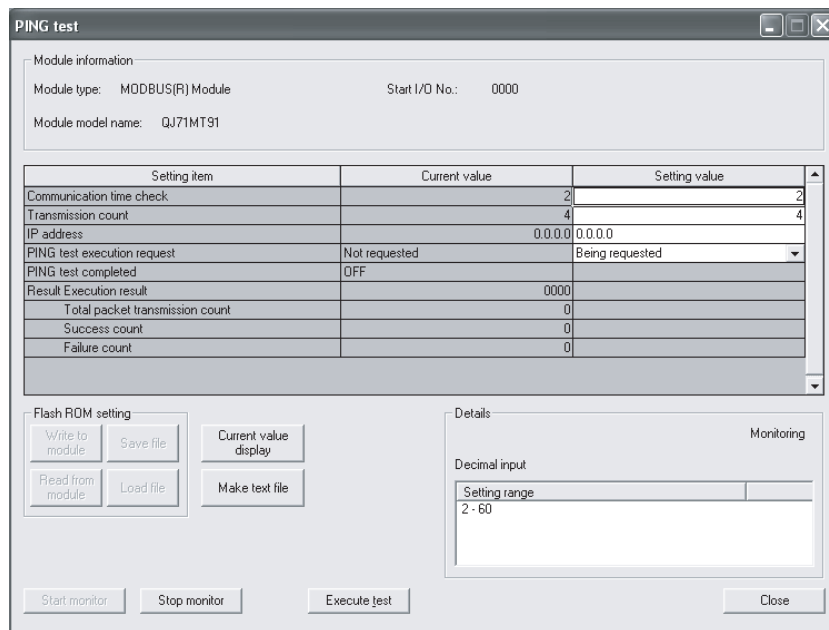

[Monitor/Test Items]

Monitor/Test Item		Buffer memory address	Reference section
Communication time check		0FE0H (4064)	Section 11.5
Transmission count		0FE1H (4065)	
IP address		0FE2H to 0FE3H (4066 to 4067)	
PING test execution request		—	
PING test completed		—	
Result	Execution result	0FE4H (4068)	
	Total packet transmission count	0FE5H (4069)	
	Success count	0FE6H (4070)	
	Failure count	0FE7H (4071)	

8.7 Parameter Setting Using GX Configurator-MB

8.7.1 Basic parameters

[Purpose]

Set the basic parameters on the basic parameter screen.

[Operating procedure]

[Initial setting] screen → [Basic parameter]

[Setting screen]

Basic parameter

Module information
 Module type: MODBUS(R) Module Start I/O No.: 0000
 Module model name: QJ71MT91

Setting item	Setting value
TCP/UDP/IP setting	60
TCP ULP timer value(Units:500ms)	
TCP zero window timer value(Units:500ms)	20
TCP resend timer value(Units:500ms)	20
TCP end timer value(Units:500ms)	40
IP reassembly timer value(Units:500ms)	10
Split reception monitoring timer value(Units:500ms)	60
KeepAlive	Used

Details
 Decimal input
 Setting range
 2 - 2400

Make text file End setup Cancel

[Setting items]

For the basic parameter setting, set the data format or setting range value of each item in the Setting value column, and click the **End setup** button to save the set values.

Setting Item		Buffer memory address	Reference section
TCP/UDP/IP setting	TCP/UDP/IP monitoring timer	TCP ULP timer value	0000H (0)
		TCP zero window timer value	0001H (1)
		TCP resend timer value	0002H (2)
		TCP end timer value	0003H (3)
		IP reassembly timer value	0004H (4)
		Split reception monitoring timer value	0005H (5)
	KeepAlive	KeepAlive	0006H (6)
		KeepAlive start timer value	0007H (7)
		KeepAlive interval timer value	0008H (8)
		KeepAlive resend count	0009H (9)
	Routing information	Router relay function	000AH (10)
		Subnet mask pattern	000BH to 000CH (11 to 12)
		Default router IP address	000DH to 000EH (13 to 14)
		Number of routers set	000FH (15)
		Router information 1 to 8 Subnet address Router IP address	0010H to 002FH (16 to 47)
GX Developer connection information setting	Number of TCP connections for GX Developer connection	0030H (48)	Section 7.2

Setting Item			Buffer memory address	Reference section
TCP/UDP/ IP setting	MODBUS® / TCP setting	Local slave station port No.	0110H (272)	Section 7.2
		Target slave port No. for automatic communication function	0111H (273)	
		CPU response monitoring timer value	0114H (276)	
		Preferred node specification 1 to 64 IP address Number of connections	0115H to 01D4H (277 to 468)	

8.7.2 Automatic communication parameters

[Purpose]

Set the automatic communication parameters on the Automatic communication parameter screen.

[Operating procedure]

Initial setting screen → **Automatic communication parameter**

[Setting screen]

Automatic communication parameter

Module information
 Module type: MODBUS(R) Module Start I/O No.: 0000
 Module model name: QJ71MT91

Setting item	Setting value
Automatic communication parameter 1 Target station IP address	0.0.0.0
Module ID	255
Repeat interval timer value(Units:10ms)	0
Response monitoring timer value(Units:500ms)	0
Type specification of the target MODBUS(R) device	No select
Read setting Head buffer memory address	0000
Target MODBUS(R) device head number	0

Details
 IP Address input
 Setting range
 0.0.0.0 - 255.255.255.254

Make text file End setup Cancel

[Setting items]

For the automatic communication parameter setting, set the data format or setting range value of each item in the Setting value column, and click the **End setup** button to save the set values.

Setting Item		Buffer memory address	Reference section	
Automatic communication parameter 1	Target station IP address	0200H to 0201H (512 to 513)	Section 7.3	
	Module ID	0202H (514)		
	Repeat interval timer value	0203H (515)		
	Response monitoring timer value	0204H (516)		
	Type specification of the target MODBUS [®] device	0205H (517)		
	Read setting	Head buffer memory address		0206H (518)
		Target MODBUS [®] device head number		0207H (519)
		Access points		0208H (520)
	Write setting	Head buffer memory address		0209H (521)
		Target MODBUS [®] device head number		020AH (522)
Access points		020BH (523)		
Automatic communication parameter 2 to 64	(Same as in automatic communication parameter 1)	020CH to 04FFH (524 to 1279)		

POINT

After the automatic communication parameters have been written to the programmable controller CPU, the automatic communication function is operated when the programmable controller is powered ON from OFF or the programmable controller CPU is reset (with the programmable controller CPU's RUN/STOP switch set to RUN).

8.7.3 MODBUS® device assignment parameters

[Purpose]

Set the MODBUS® device assignment parameters on the MODBUS® device assignment parameter screen.

[Operating procedure]

Initial setting screen → **MODBUS(R) device assignment**

[Setting screen]

MODBUS(R) device assignment parameter

Module information
 Module type: MODBUS(R) Module Start I/O No.: 0000
 Module model name: QJ71MT91

Setting item	Setting value
Coil assignment 1 Device	Y0
Head coil number (Specify "Actual device No. -1".)	0
Assignment points	8192
Coil assignment 2 Device	M0
Head coil number (Specify "Actual device No. -1".)	8192
Assignment points	8192
Coil assignment 3 Device	SM0

Details
 Device input
 Setting range
 SM
 X
 Y
 M

Make text file End setup Cancel

[Setting items]

For the MODBUS[®] device assignment parameter setting, set the data format or setting range value of each item in the Setting value column, and click the **End setup** button to save the set values.

Setting Item		Buffer memory address	Reference section
Coil assignment 1	Device	Device code	0900H (2304)
		Head device number	0901H (2305)
	Head coil number		0902H (2306)
	Assignment points		0903H (2307)
Coil assignment 2 to 16	(Same as in coil assignment 1)		0904H to 093FH (2308 to 2367)
Input assignment 1	Device	Device code	0940H (2368)
		Head device number	0941H (2369)
	Head input number		0942H (2370)
	Assignment points		0943H (2371)
Input assignment 2 to 16	(Same as in input assignment 1)		0944H to 097FH (2372 to 2431)
Input register assignment 1	Device (*1)	Device code	0980H (2432)
		Head device number	0981H (2433)
	Head input register number		0982H (2434)
	Assignment points		0983H (2435)
Input register assignment 2 to 16	(Same as in input register assignment 1)		0984H to 09BFH (2436 to 2495)
Holding register assignment 1	Device (*1)	Device code	09C0H (2496)
		Head device number	09C1H (2497)
	Head holding register number		09C2H (2498)
	Assignment points		09C3H (2499)
Holding register assignment 2 to 16	(Same as in holding register assignment 1)		09C4H to 09FFH (2500 to 2559)

Section 7.4

*1: QJ71MT91 buffer memory (user free area: 5000H to 5FFFH) setting
 When the MODBUS[®] device is the input register or holding register, the QJ71MT91 buffer memory (user free area) setting is available.
 For setting, enter a value as a hexadecimal constant as shown below.
 Example) 5000H
 Enter a value "H5000".

9 PROGRAMMING

9.1 Parameter Setting

This chapter explains how to set parameters with sequence programs. When applying the following program examples to the actual system, make sure to examine the applicability and confirm that it will not cause system control problems. On-screen parameter setting for the QJ71MT91 is available by use of the utility package (GX Configurator-MB), reducing sequence programs. Refer to Chapter 8 for details of the utility package (GX Configurator-MB) operation method.

9.1.1 Basic parameter setting

(1) Basic parameter setting method

Make basic parameter setting in the following procedure.

- 1) Store the parameters into the basic parameter area (address: 0000H to 01D4H) of the buffer memory.
- 2) Turn on Basic parameter setting request (Y1).

(2) I/O signals used for basic parameter setting

Use the following I/O signals for basic parameter setting.

Signal	Signal Name
X0	Module READY ON : Accessible OFF : Inaccessible
X1	Basic parameter setting, normally completed ON : Normally completed OFF : —
X2	Basic parameter setting, error completed ON : Error completed OFF : —
X3	Basic parameter setting existence ON : Parameters set OFF : No parameters set
Y1	Basic parameter setting request ON : Being requested OFF : Not requested

(3) Timing charts for basic parameter setting
 (a) When setting is completed normally

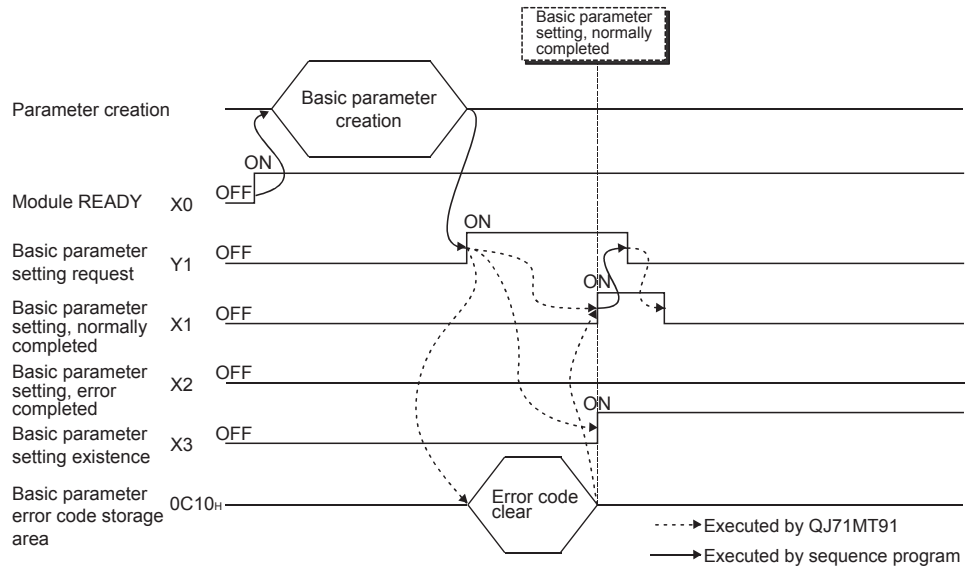

(b) When setting is completed with an error

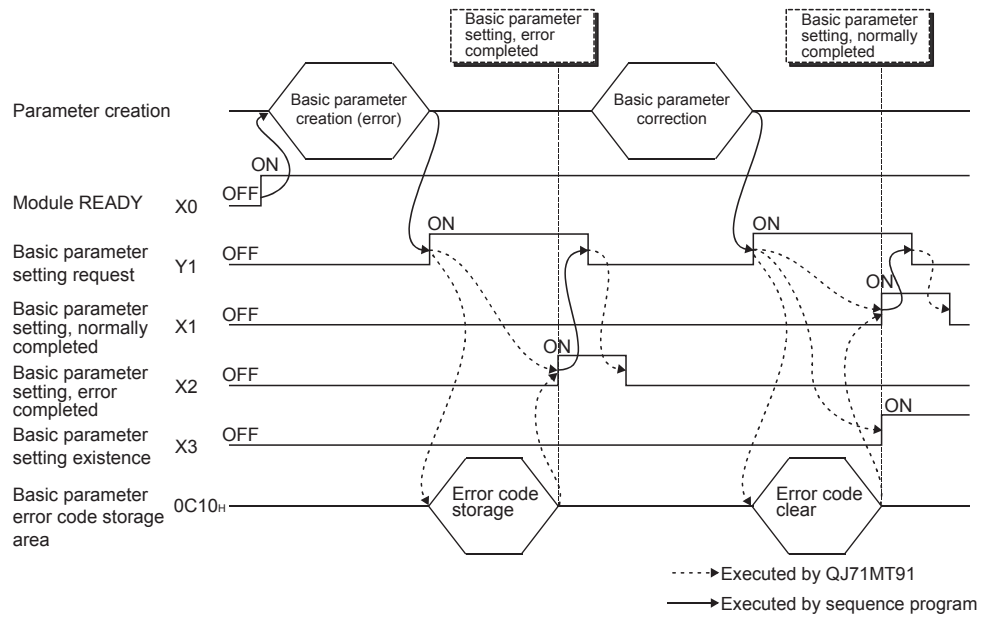

(4) Precautions for basic parameter setting

- (a) When setting the basic parameters with a sequence program, set the basic parameter starting method (b0) of the intelligent function module switch 2 (refer to Section 6.6) to ON (Start with the user-set parameters).
- (b) Turn ON Basic parameter setting request (Y1) after Module READY (X0) has turned ON.
- (c) After Basic parameter setting request (Y1) is turned ON to start the parameter setting processing, do not turn ON/OFF any other output signal (Y signal) until Basic parameter setting, normally completed (X1) or Basic parameter setting, error completed (X2) turns ON.
- (d) When the basic parameter setting is completed with an error, an error code is stored into the basic parameter error code storage area (address: C10H (3088)) of the buffer memory.
Check the stored error code, take corrective action, and make a parameter setting request again. Refer to Section 11.3 for details of the error code.
- (e) Basic parameter setting existence (X3) turns ON when the default parameters exist.
- (f) The basic parameter setting is not allowed in the offline mode (intelligent function module switch 1: 0001H).
Set the basic parameters in the online mode (intelligent function module switch 1: 0000H).

REMARK

Refer to Section 6.6.1 for details of whether each function can be executed or not depending on the basic parameter setting existence.

9.1.2 Automatic communication parameter setting

(1) Automatic communication parameter setting method

Make automatic communication parameter setting in the following procedure.

- 1) Store the parameters into the automatic communication parameter area (address: 0200_H to 04FF_H) of the buffer memory.
- 2) Turn ON Automatic communication parameter setting request/automatic communication start request (Y4).

(2) I/O signals for automatic communication parameter setting

Use the following I/O signals for automatic communication parameter setting.

Signal	Signal Name
X0	Module READY ON : Accessible OFF : Inaccessible
X3	Basic parameter setting existence ON : Parameter set OFF : No parameters set
X4	Automatic communication parameter setting, normally completed ON : Normally completed OFF : —
X5	Automatic communication parameter setting, error completed ON : Error completed OFF : —
X6	Automatic communication operation status ON : Operating OFF : Stopped
Y4	Automatic communication parameter setting request/automatic communication start request ON : Parameter setting being requested/start being requested OFF : No parameter setting requested/no start requested

(3) Timing charts for automatic communication parameter setting
 (a) When setting is completed normally

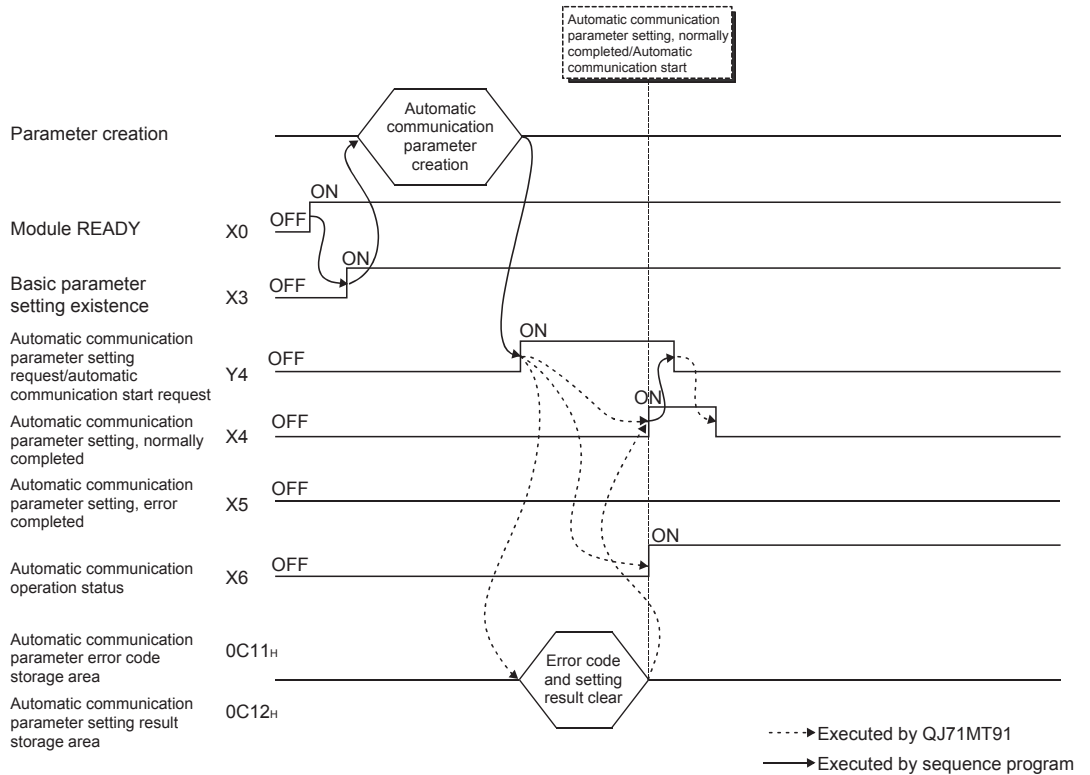

(b) When setting is completed with an error

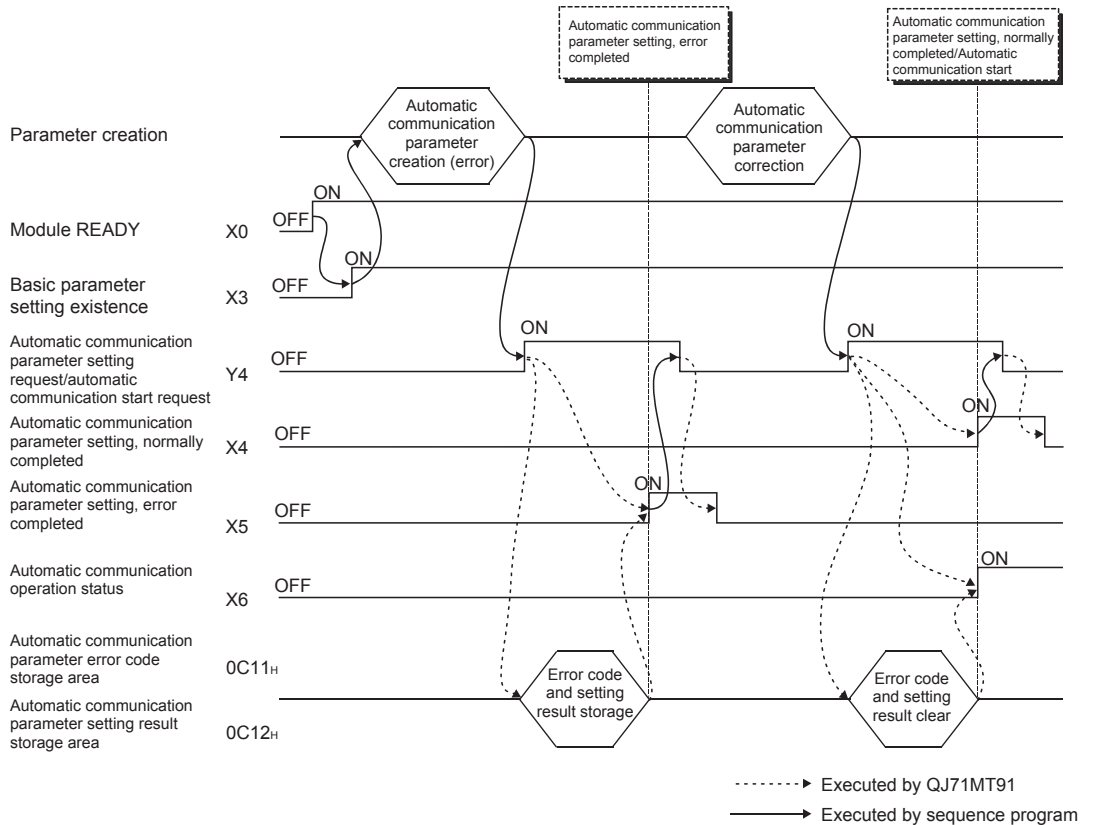

- (4) Precautions for automatic communication parameter setting
- (a) Turn ON Automatic communication parameter setting request/automatic communication start request (Y4) after Module READY (X0) and Basic parameter setting existence (X3) have turned ON.
 - (b) When the automatic communication parameter setting is completed with an error, the erroneous parameter is stored into the automatic communication parameter setting result storage area (address: 0C12H (3090)) of the buffer memory, and an error code is stored into the automatic communication parameter error code storage area (address: 0C11H (3089)). Identify the stored parameter, check its error code, take corrective action, and make a parameter setting request again. Refer to Section 11.3 for details of the error code.
 - (c) The QJ71MT91 does not clear the automatic communication function buffer input area (address: 1000H to 1FFFH (4096 to 8191)) and automatic communication function buffer output area (address: 3000H to 3FFFH (12288 to 16383)), which are used for write/read setting of the buffer memory, when the automatic communication function is started in the status of Automatic communication parameter setting, normally completed (X4). Clear them as necessary using a sequence program.
 - (d) The automatic communication parameter setting is not allowed in the offline mode (intelligent function module switch 1: 0001H). Set the automatic communication parameters in the online mode (intelligent function module switch 1: 0000H).

9.1.3 MODBUS[®] device assignment parameter setting(1) MODBUS[®] device assignment parameter setting method

Make MODBUS[®] device assignment parameter setting in the following procedure.

- 1) Store the parameters into the MODBUS[®] device assignment parameter area (address: 0900H to 09FFH) of the buffer memory.
- 2) Turn ON MODBUS[®] device assignment parameter setting request (Y8).

(2) I/O signals for MODBUS[®] device assignment parameter setting

Use the following I/O signals for MODBUS[®] device assignment parameter setting.

Signal	Signal Name
X0	Module READY ON : Accessible OFF : Inaccessible
X3	Basic parameter setting existence ON : Parameters set OFF : No parameters set
X8	MODBUS [®] device assignment parameter setting, normally completed ON : Normally completed OFF : —
X9	MODBUS [®] device assignment parameter setting, error completed ON : Error completed OFF : —
XA	MODBUS [®] device assignment parameter setting existence ON : Parameters set OFF : No parameters set
Y8	MODBUS [®] device assignment parameter setting request ON : Being requested OFF : Not requested

(3) Timing charts for MODBUS[®] device assignment parameter setting
 (a) When setting is completed normally

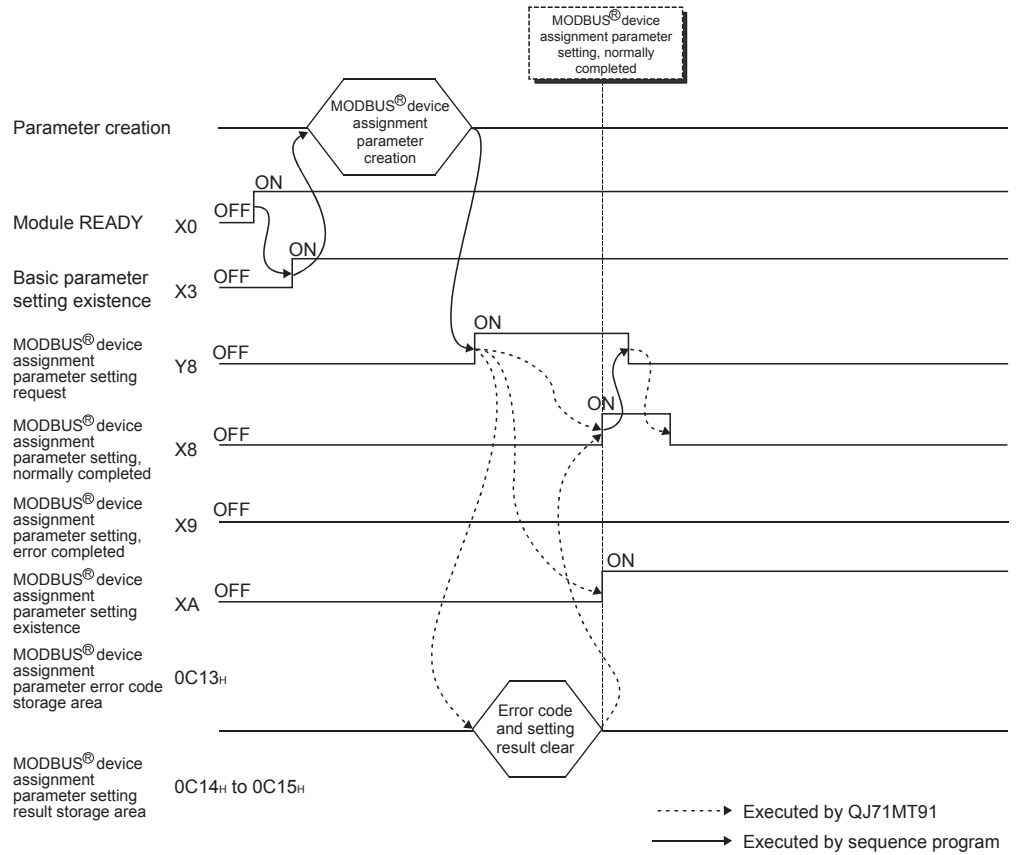

(b) When setting is completed with an error

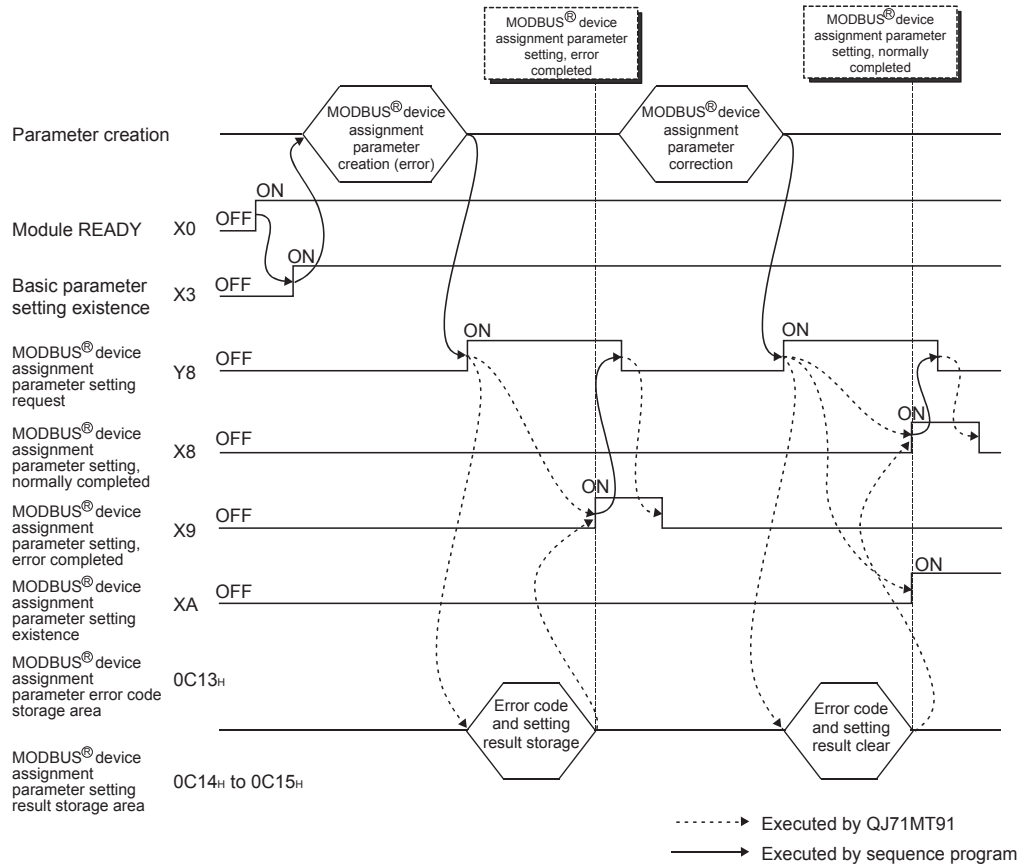

- (4) Precautions for MODBUS[®] device assignment parameter setting
- (a) When setting the MODBUS[®] device assignment parameters with a sequence program, set the MODBUS[®] device assignment parameter starting method of the intelligent function module switch setting (refer to Section 6.6) to ON (Start with the user-set parameters).
 - (b) Turn ON MODBUS[®] device assignment parameter setting request (Y8) after Module READY (X0) and Basic parameter setting existence (X3) have turned ON.
 - (c) When the MODBUS[®] device assignment parameter setting, error completed (X9) has turned ON, correct the corresponding parameter in the following procedure.
 - 1) Refer to the MODBUS[®] device assignment parameter setting result storage area (address: 0C14H to 0C15H (3092 to 3093)) to identify the erroneous parameter.
 - 2) Refer to the MODBUS[®] device assignment parameter error code storage area (address: 0C13H (3091)) to check the error details, and correct the parameter.
 - 3) Make a MODBUS[®] device assignment parameter setting request again. Refer to Section 11.3.1 for details of the MODBUS[®] device assignment parameter error code storage area and MODBUS[®] device assignment parameter setting result storage area.
 - (d) MODBUS[®] device assignment parameter setting existence (XA) turns ON also when the default parameters exist.
 - (e) The MODBUS[®] device assignment parameter setting is not allowed in the offline mode (intelligent function module switch 1: 0001H). Set the MODBUS[®] device assignment parameters in the online mode (intelligent function module switch 1: 0000H).
 - (f) The QJ71MT91 sends an exception response to the master if it receives a MODBUS[®] device data read/write request message from the master before the MODBUS[®] device assignment parameters are set normally.
 - (g) MODBUS[®] device assignment parameter setting via a sequence program can be made again at any time after power-up of the QJ71MT91.

REMARK

Refer to Section 6.6.1 for details of whether each function can be executed or not depending on the MODBUS[®] device assignment parameter setting existence.

9.2 Program Example for Normal System Configuration

9.2.1 System configuration and program conditions

(1) System configuration

A program will be explained as an example to realize the following specifications for the setting target QJ71MT91 (192.1.0.1).

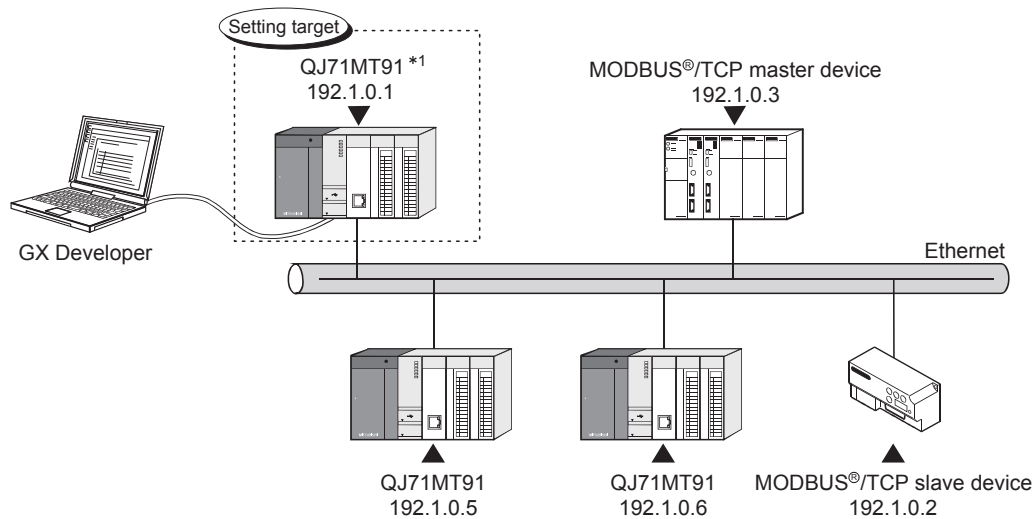

*1: This QJ71MT91 is assumed to be mounted in Slot 0 of the base unit with the head I/O No. set to 0.

(a) Automatic communication function

The setting target QJ71MT91 (192.1.0.1) and MODBUS® /TCP slave device (192.1.0.2) communicate with each other using the automatic communication function.

Set automatic communication parameters to the setting target QJ71MT91.

[Communication details]

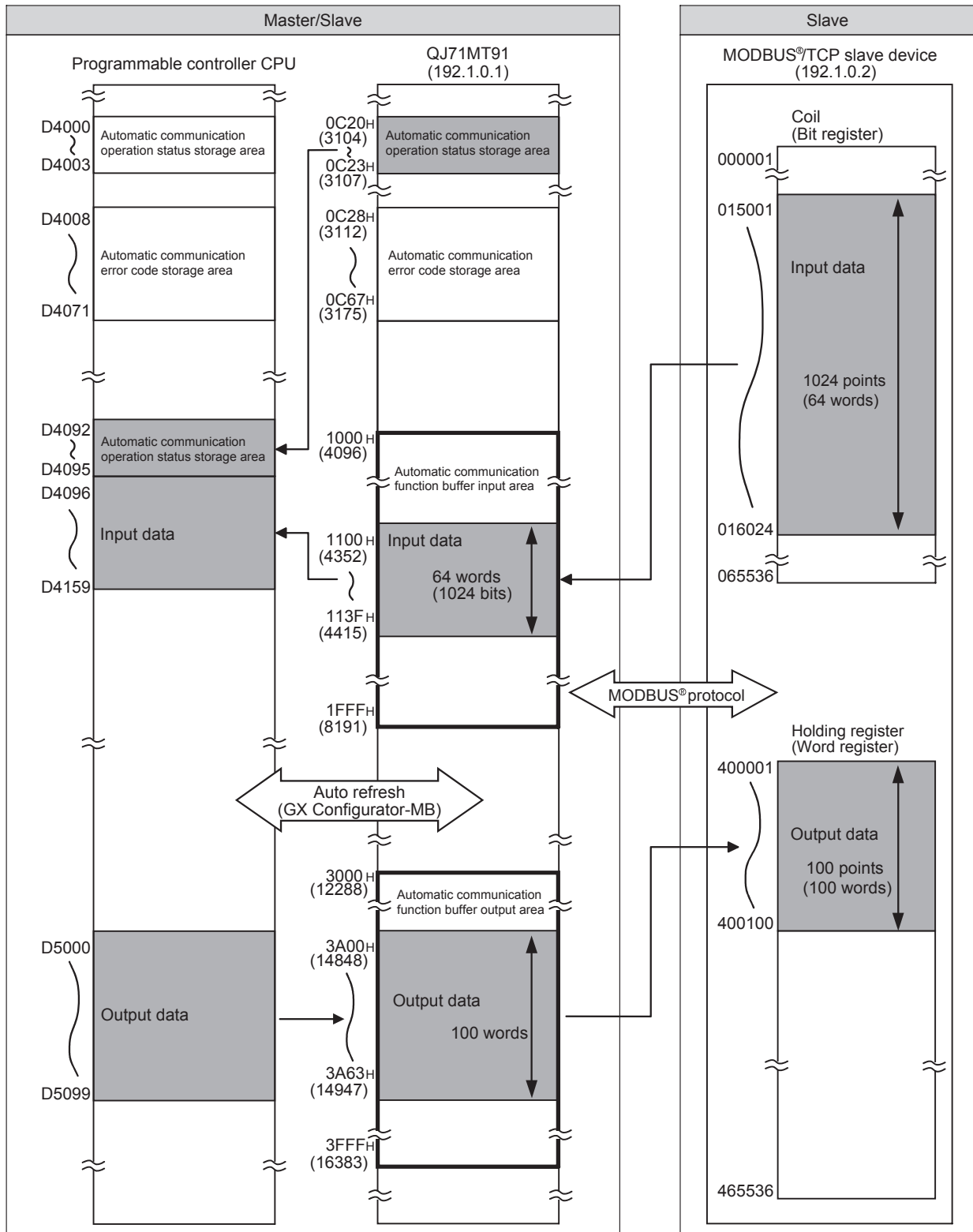

(b) MODBUS® device assignment function

The setting target QJ71MT91 (192.1.0.1) uses the MODBUS® device assignment function. Set the MODBUS® device assignment parameters to the setting target QJ71MT91.

[Assignment details]

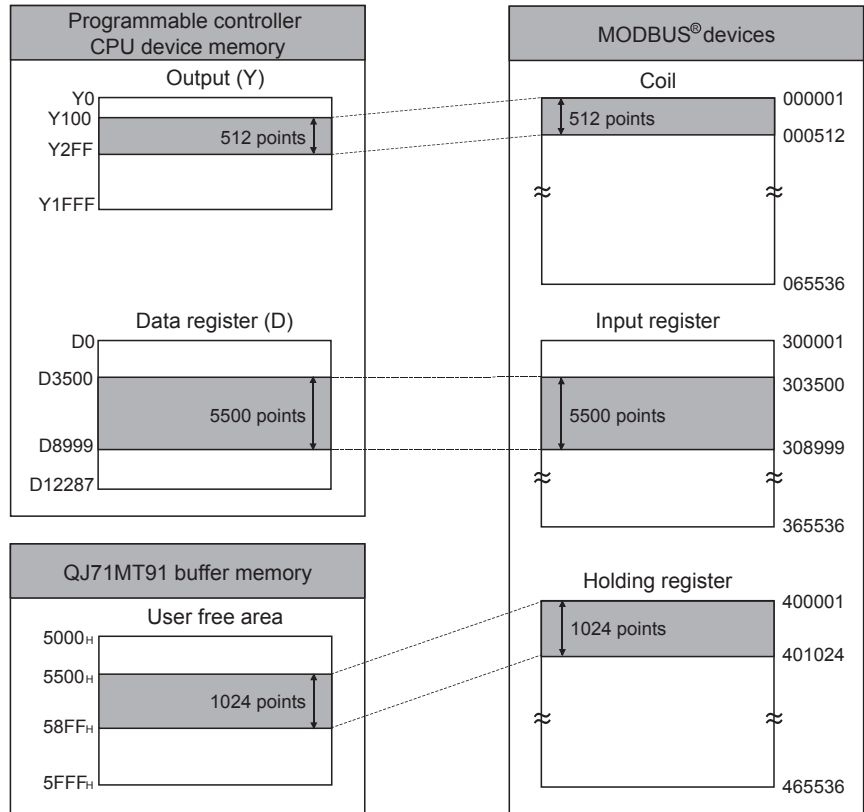

(2) Parameter setting details

The following table gives the setting details of the parameters set in the program example.

(a) Basic parameters

Setting Item		Buffer Memory Address	Set Value
TCP/UDP/IP monitoring timer	TCP ULP timer value	0000 _H (0)	60 (30s)
	TCP zero window timer value	0001 _H (1)	20 (10s)
	TCP resend timer value	0002 _H (2)	20 (10s)
	TCP end timer value	0003 _H (3)	40 (20s)
	IP reassembly timer value	0004 _H (4)	10 (5s)
	Split reception monitoring timer value	0005 _H (5)	60 (30s)
KeepAlive	KeepAlive	0006 _H (6)	1 (Used)
	KeepAlive start timer value	0007 _H (7)	1200 (600s)
	KeepAlive interval timer value	0008 _H (8)	20 (10s)
	KeepAlive resend count	0009 _H (9)	3
Routing information	Router relay function	000A _H (10)	0 (Not used)
	Subnet mask pattern	000B _H to 000C _H (11 to 12)	FFFFFF00 _H (255.255.255.0)
	Default router IP address	000D _H to 000E _H (13 to 14)	00000000 _H (0.0.0.0)
	Number of routers set	000F _H (15)	0
	Router information 1	Subnet address	0010 _H to 0011 _H (16 to 17)
	Router IP address	0012 _H to 0013 _H (18 to 19)	00000000 _H (0.0.0.0)
GX Developer connection information setting	Number of TCP connectors for GX Developer connection	0030 _H (48)	1
MODBUS [®] /TCP setting	Local slave station port No.	0110 _H (272)	502
	Target slave port No. for automatic communication function	0111 _H (273)	502
	CPU response monitoring timer value	0114 _H (276)	10
	Preferred node specification 1	IP address	0115 _H to 0116 _H (277 to 278)
	Number of connections	0117 _H (279)	2

(b) Automatic communication parameters

Setting Item		Buffer Memory Address	Set Value	
Automatic communication parameter 1	Target station IP address	0200 _H to 0201 _H (512 to 513)	C0010002 _H (192.1.0.2)	
	Module ID	0202 _H (514)	255	
	Repeat interval timer value	0203 _H (515)	1200(120s)	
	Response monitoring timer value	0204 _H (516)	60(30s)	
	Type specification of the target MODBUS [®] device	0205 _H (517)	0100 _H (Read coils)	
	Read setting	Head buffer memory address	0206 _H (518)	1100 _H
		Target MODBUS [®] device head number	0207 _H (519)	15000
Access points		0208 _H (520)	1024	
Automatic communication parameter 2	Target station IP address	020C _H to 020D _H (524 to 525)	C0010002 _H (192.1.0.2)	
	Module ID	020E _H (526)	255	
	Repeat interval timer value	020F _H (527)	10(100ms)	
	Response monitoring timer value	0210 _H (528)	60(30s)	
	Type specification of the target MODBUS [®] device	0211 _H (529)	0005 _H (Write holding registers)	
	Write setting	Head buffer memory address	0215 _H (533)	3A00 _H
		Target MODBUS [®] device head number	0216 _H (534)	0
Access points		0217 _H (535)	100	

(c) MODBUS[®] device assignment parameters

Setting Item		Buffer Memory Address	Set Value
Coil assignment 1	Device code	0900 _H (2304)	009D _H (Y: Output)
	Head device number	0901 _H (2305)	0100 _H
	Head coil number	0902 _H (2306)	0 (000001)
	Assignment points	0903 _H (2307)	512 (points)
Input register assignment 1	Device code	0980 _H (2432)	00A8 _H (D: Data register)
	Head device number	0981 _H (2433)	3500
	Head input register number	0982 _H (2434)	3499 (303500)
	Assignment points	0983 _H (2435)	5500 (points)
Holding register assignment 1	Device code	09C0 _H (2496)	F000 _H (User free area)
	Head device number	09C1 _H (2497)	5500 _H
	Head holding register number	09C2 _H (2498)	0 (400001)
	Assignment points	09C3 _H (2499)	1024 (points)

(3) Devices used in program

Device Name		Device	Application
QJ71MT91 input/output	Input	X0	Module READY
		X1	Basic parameter setting, normally completed
		X2	Basic parameter setting, error completed
		X3	Basic parameter setting existence
		X4	Automatic communication parameter setting, normally completed
		X5	Automatic communication parameter setting, error completed
		X6	Automatic communication operation status
		X8	MODBUS [®] device assignment parameter setting, normally completed
		X9	MODBUS [®] device assignment parameter setting, error completed
	Output	Y1	Basic parameter setting request
Y4		Automatic communication parameter setting request/automatic communication start request	
Y8		MODBUS [®] device assignment parameter setting request	
External input (command)		X20	Parameter setting command
External output		Y40	Automatic communication parameter 1 communication error
		Y41	Automatic communication parameter 2 communication error
Data register	D4000 to D4003		Automatic communication operation status storage area (parameter 1 to 64)
	D4008 to D4071		Automatic communication error code storage area (parameter 1 to 64)
	D4092 to D4095	For auto refresh	Automatic communication operation status storage area (parameter 1 to 64)
	D4096 to D4159		Automatic communication function buffer input area
	D5000 to D5099		Automatic communication function buffer output area
	D9001		Basic parameter error code acquisition
	D9002		Automatic communication parameter error code acquisition
	D9003		Automatic communication parameter setting result acquisition
	D9004		MODBUS [®] device assignment parameter error code acquisition
	D9005	MODBUS [®] device assignment	Error, device type
	D9006	parameter setting result acquisition	Error, assigned group No.
	D9100	Automatic communication error	Automatic communication parameter 1
	D9101	code	Automatic communication parameter 2
Internal relay	M1		For automatic communication parameter setting command
	M2		For MODBUS [®] device assignment parameter setting command
	M401	Automatic communication	For automatic communication parameter 1
	M402	normal	For automatic communication parameter 2

(Continued on next page)

Device Name	Device	Application	
Intelligent function module device	U0\G0 to U0\G19 U0\G48 U0\G272 to U0\G273 U0\G276 to U0\G279	Basic parameter setting area	
	U0\G512 to U0\G520 U0\G524 to U0\G529 U0\G533 to U0\G535	Automatic communication parameter setting area	
	U0\G2304 to U0\G2307 U0\G2432 to U0\G2435 U0\G2496 to U0\G2499	MODBUS [®] device assignment parameter setting area	
	U0\G3088	Basic parameter error code storage area	
	U0\G3089	Automatic communication parameter error code storage area	
	U0\G3090	Automatic communication parameter setting result storage area	
	U0\G3091	MODBUS [®] device assignment parameter error code storage area	
	U0\G3092	MODBUS [®] device assignment	Error, device type
	U0\G3093	parameter setting result storage area	Error, assigned group No.
	U0\G3104 to U0\G3107	Automatic communication operation status storage area (parameter 1 to 64)	
	U0\G3112 to U0\G3175	Automatic communication error code storage area (parameter 1 to 64)	
	U0\G4096 to U0\G8191	Automatic communication function buffer input area	
	U0\G12288 to U0\G16383	Automatic communication function buffer output area	

9.2.2 Program using utility package

(1) Intelligent function module switch setting

Set the intelligent function module switches by clicking **Switch setting** on <<I/O assignment>> of GX Developer.

For the program example, set intelligent function module switches as described below.

Intelligent Function Module Switch	Setting Details	Set Value
Switch 1	No need to set (initial value (online))	—
Switch 2	1) Basic parameter starting method Start with the user-set parameters (b0: 1) 2) MODBUS® device assignment parameter starting method Start with the user-set parameters (b1: 1) 3) Online change enable/disable setting Online change enabled (b2: 1) 4) Send frame specification Data are sent in Ethernet (V2.0)-compliant frame (b3: 0)	0007H
Switch 3	Set the (upper half) of the IP address	C001H
Switch 4	Set the (lower half) of the IP address	0001H
Switch 5	No need to set	—

(2) Parameter setting

Set the parameters from the [Initial setting] screen of GX Configurator-MB.

(a) Basic parameters

Set the basic parameters on the [Basic parameter] screen.

Set the values shown in Section 9.2.1 (2) (a).

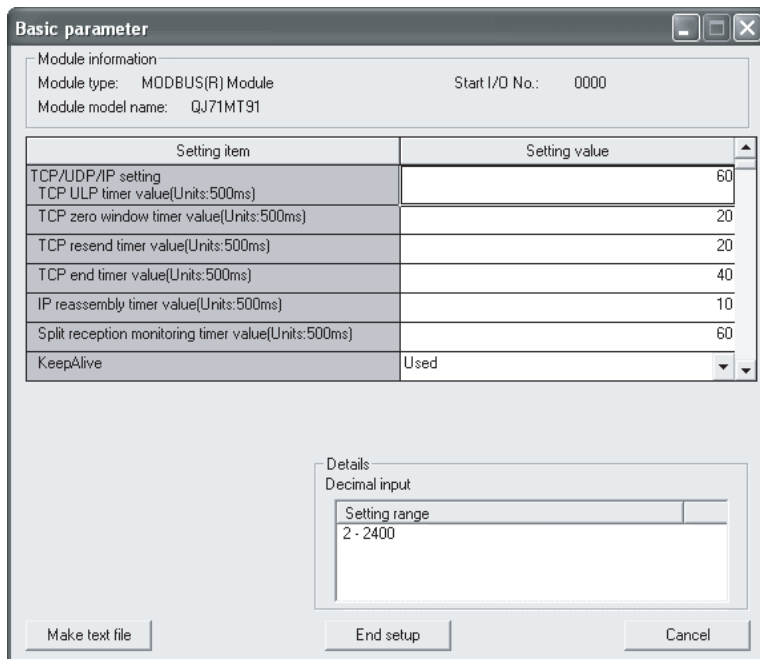

POINT

When the basic parameter screen is displayed, it shows the initial values.

(b) Automatic communication parameters

Set the automatic communication parameters on the [Automatic communication parameter] screen.

Set the values shown in Section 9.2.1 (2) (b).

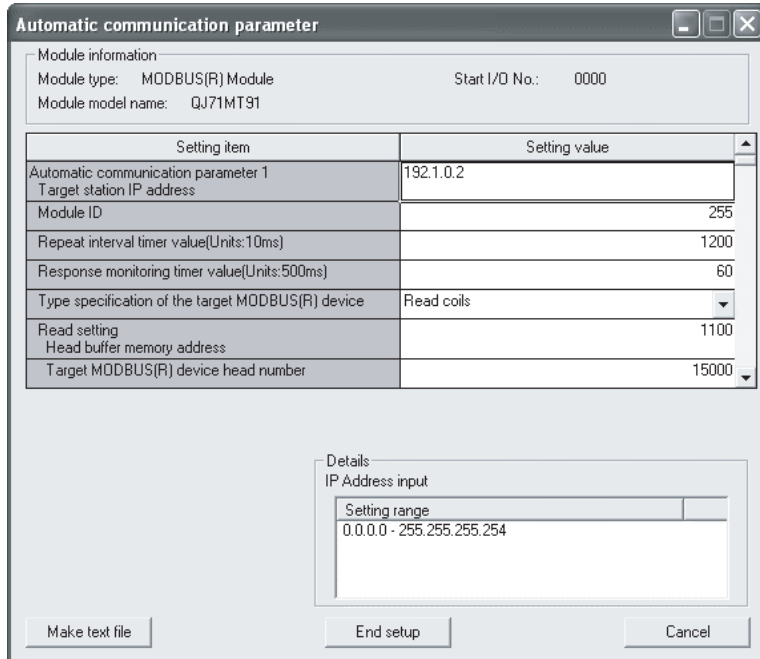

(c) MODBUS® device assignment parameters

Set the MODBUS® device assignment parameters on the [MODBUS(R) device assignment parameter] screen.

Set the values shown in Section 9.2.1 (2) (c).

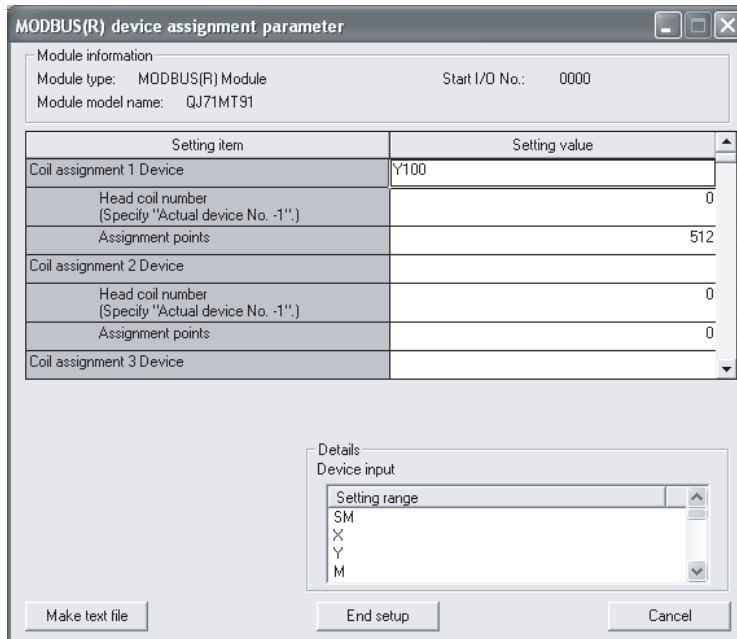

POINT

When the MODBUS® device assignment parameter screen is displayed, it shows the initial values. Delete unnecessary initial values.

(3) Auto refresh setting

Make auto refresh setting from the **Auto refresh setting** screen of GX Configurator-MB.

Set the following items for the program example.

Setting Item	Module side Transfer word count	Module side Buffer offset	PLC side Device
Automatic communication function buffer input area	64	256(100H)	D4096
Automatic communication function buffer output area	100	2560(A00H)	D5000
Automatic communication operation status	—	—	D4092

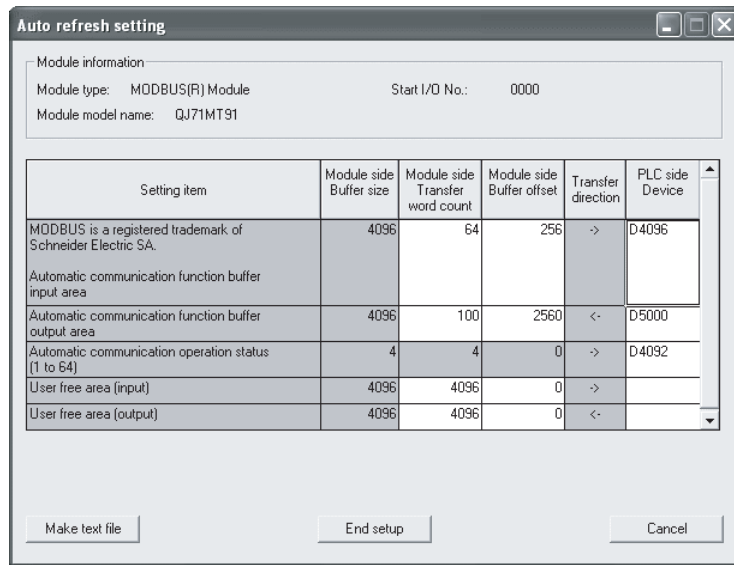

(4) Automatic communication function

For a program example for error code acquisition at an automatic communication error, refer to <<Handling of automatic communication error>> in (5).

POINT
The automatic communication error code can be monitored on the "Automatic communication status" screen of GX Configurator-MB.

(5) Program example

<<Processing for normal automatic communication: For automatic communication parameter 1>>

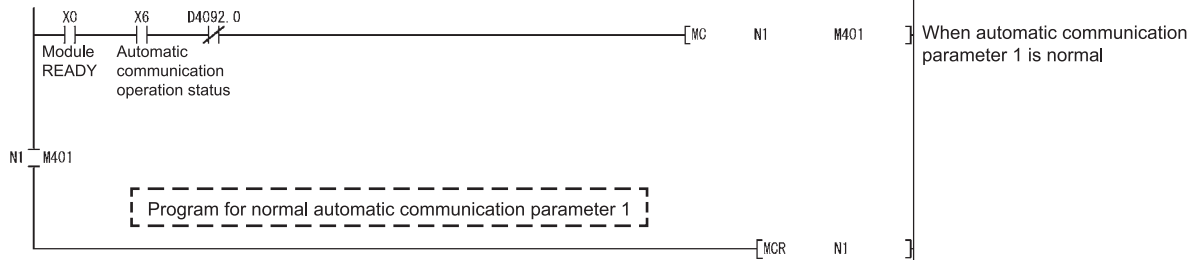

<<Processing for normal automatic communication: For automatic communication parameter 2>>

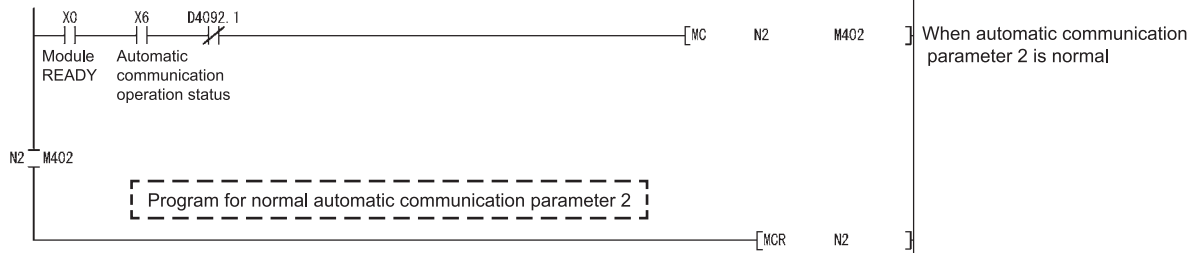

<<Handling of automatic communication error>>

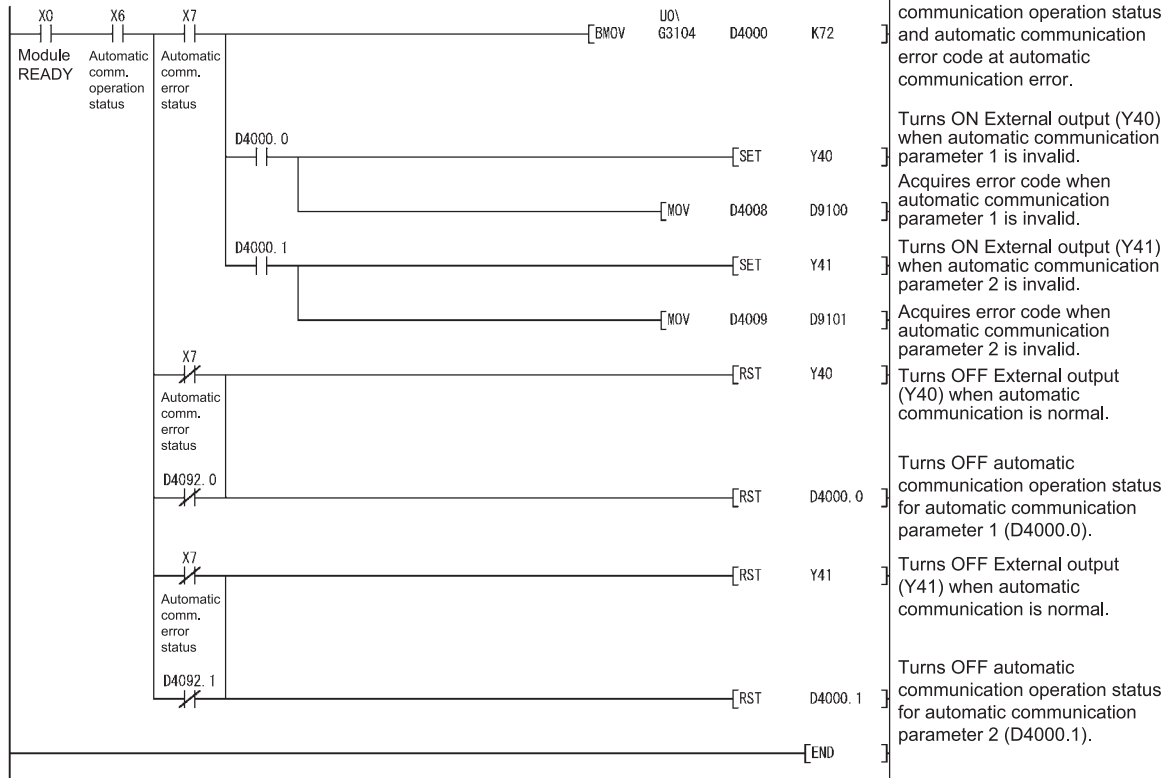

9.2.3 Program without using utility package

(1) Intelligent function module switch setting

Set the intelligent function module switches by clicking **Switch setting** on <<I/O assignment>> of GX Developer.

For the program example, set intelligent function module switches as described below.

Intelligent Function Module Switch	Setting Details	Set Value
Switch 1	No need to set (initial value (online))	—
Switch 2	1) Basic parameter starting method Start with the user-set parameters (b0: 1) 2) MODBUS [®] device assignment parameter starting method Start with the user-set parameters (b1: 1) 3) Online change enable/disable setting Online change enabled (b2: 1) 4) Send frame specification Data are sent in Ethernet (V2.0)-compliant frame (b3: 0)	0007H (*1) (*2) (*3)
Switch 3	Set the (upper half) of the IP address	C001H
Switch 4	Set the (lower half) of the IP address	0001H
Switch 5	No need to set	—

*1: Set 0006H to start with the default basic parameters.

*2: Set 0005H to start with the default MODBUS[®] device assignment parameters.

*3: Set 0004H to start with the default basic and MODBUS[®] device assignment parameters.

(2) Parameter setting

Set the parameters using a sequence program.

Parameter setting can be omitted under the following conditions.

Parameter	Parameter Setting Omitting Condition	
	Condition	Setting method
Basic parameters	Use the default parameters. (*1)	With the intelligent function module switch 2, set the basic parameter starting method (bit 0) to "0: Start with the default parameters". (Refer to (1) in this section.)
Automatic communication parameters	Do not use the automatic communication function (master function).	No need to set.
MODBUS [®] device assignment parameters	Use the default parameters. (*2)	With the intelligent function module switch 2, set the MODBUS [®] device assignment parameter starting method (bit 1) to "0: Start with the default parameters". (Refer to (1) in this section.)
	Do not use the MODBUS [®] device assignment function (slave function).	No need to set.

*1: To utilize the basic parameters with the initial values (refer to Section 7.2.1), it is recommended to use the default parameters.

*2: When the device assignment of the CPU is not changed, it is recommended to use the default parameters.

(a) Basic parameters

For a program example of the basic parameters, refer to <<Basic parameter setting>> in (5).

(b) Automatic communication parameters

For a program example of the automatic communication parameters, refer to <<Automatic communication parameter setting>> in (5).

(c) MODBUS[®] device assignment parameters

For a program example of the MODBUS[®] device assignment parameters, refer to <<MODBUS device assignment parameter setting>> in (5).

(3) Auto refresh setting

For the processing equivalent to the auto refresh setting (GX Configurator-MB), refer to <<Refresh processing>> in (5).

(4) Automatic communication function

(a) For a program example for normal automatic communication, refer to <<Processing for normal automatic communication>> in (5).

(b) For a program example for error code acquisition at an automatic communication error, refer to <<Handling of automatic communication error>> in (5).

(5) Program example

<<Basic parameter setting>>

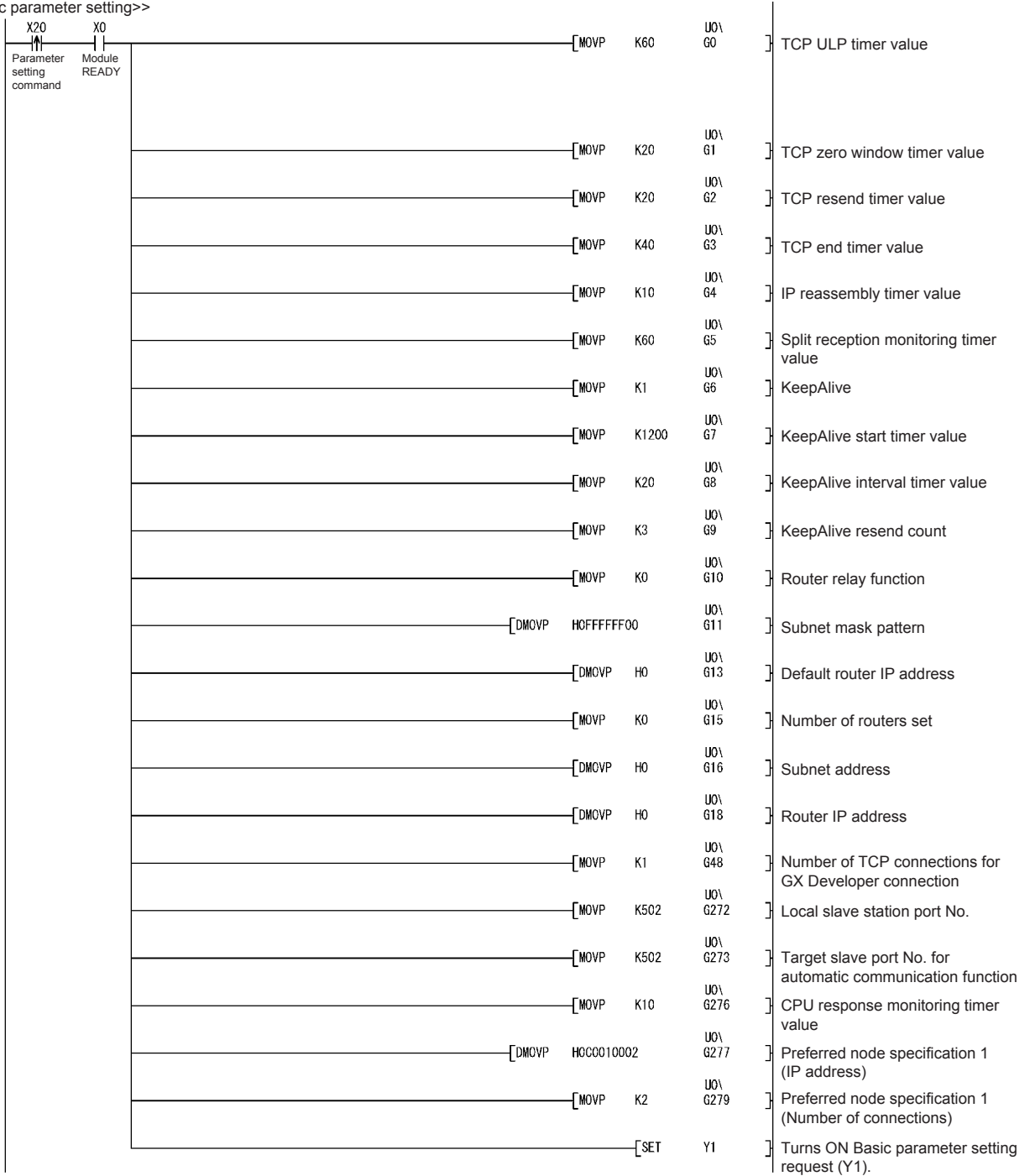

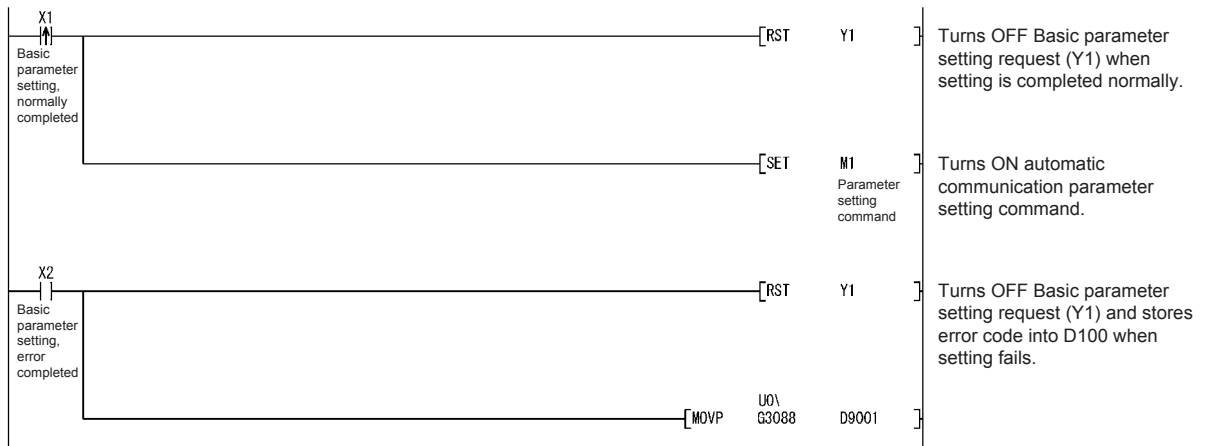

<<Automatic communication parameter setting>>

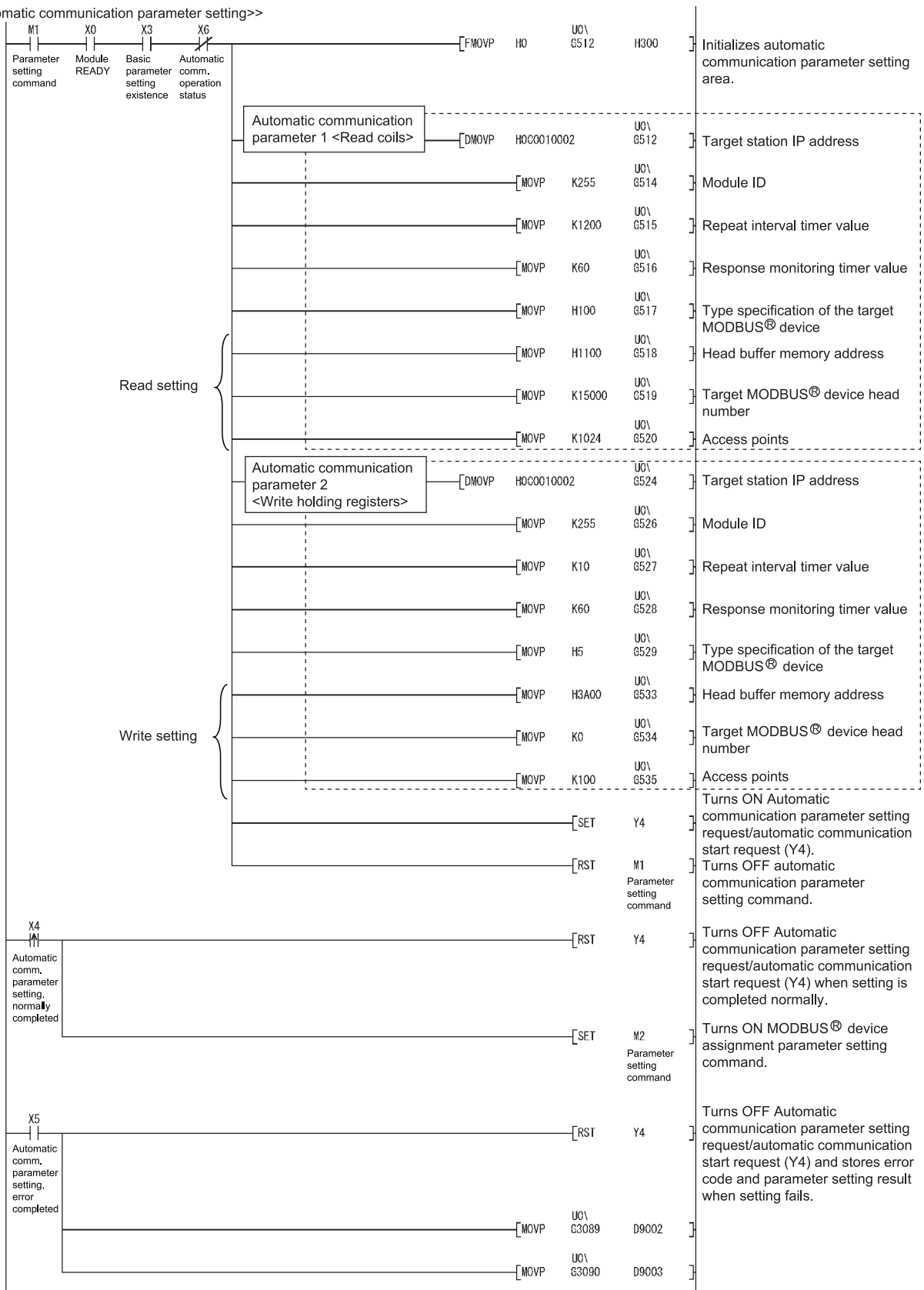

<<MODBUS device assignment parameter setting>>

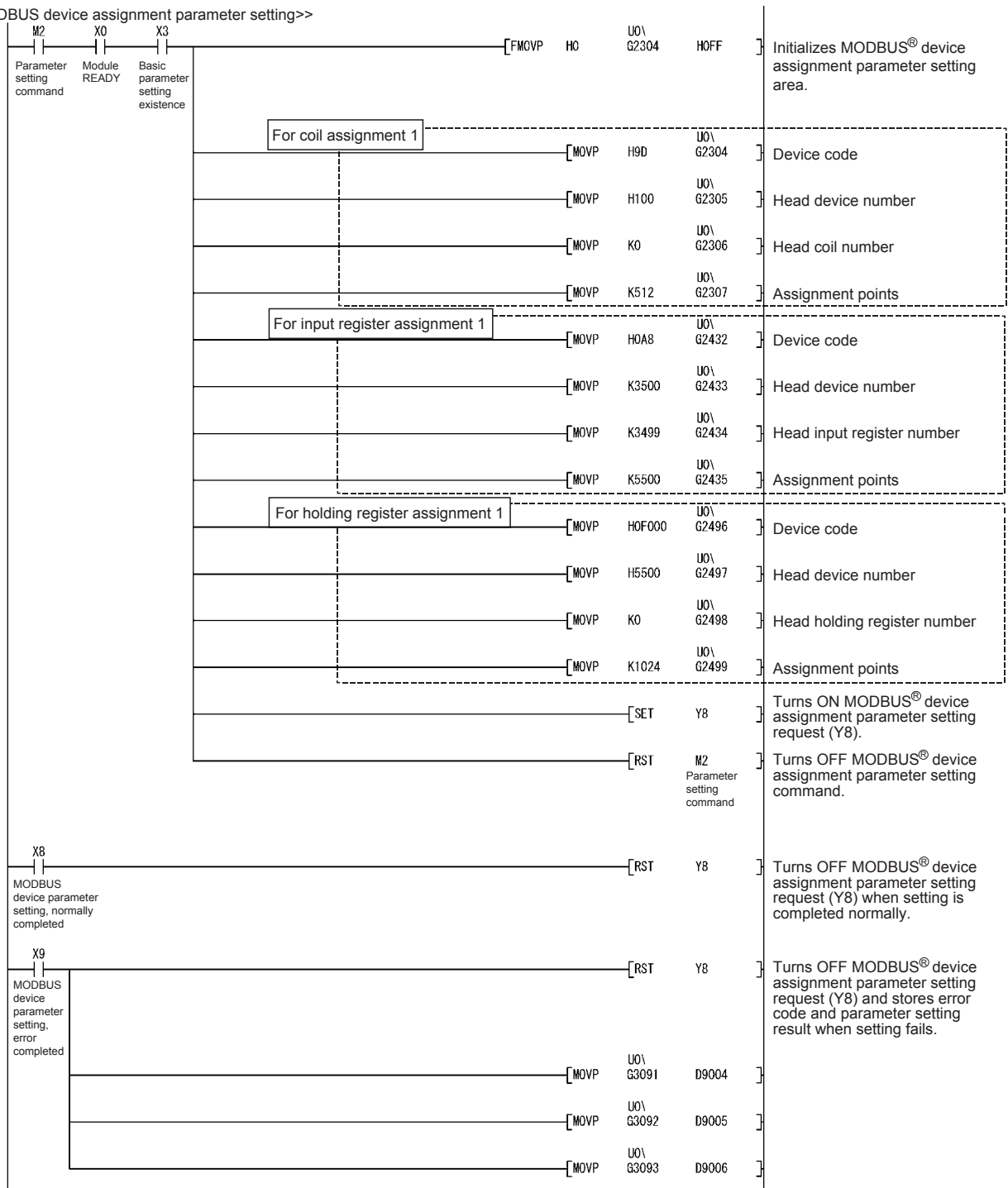

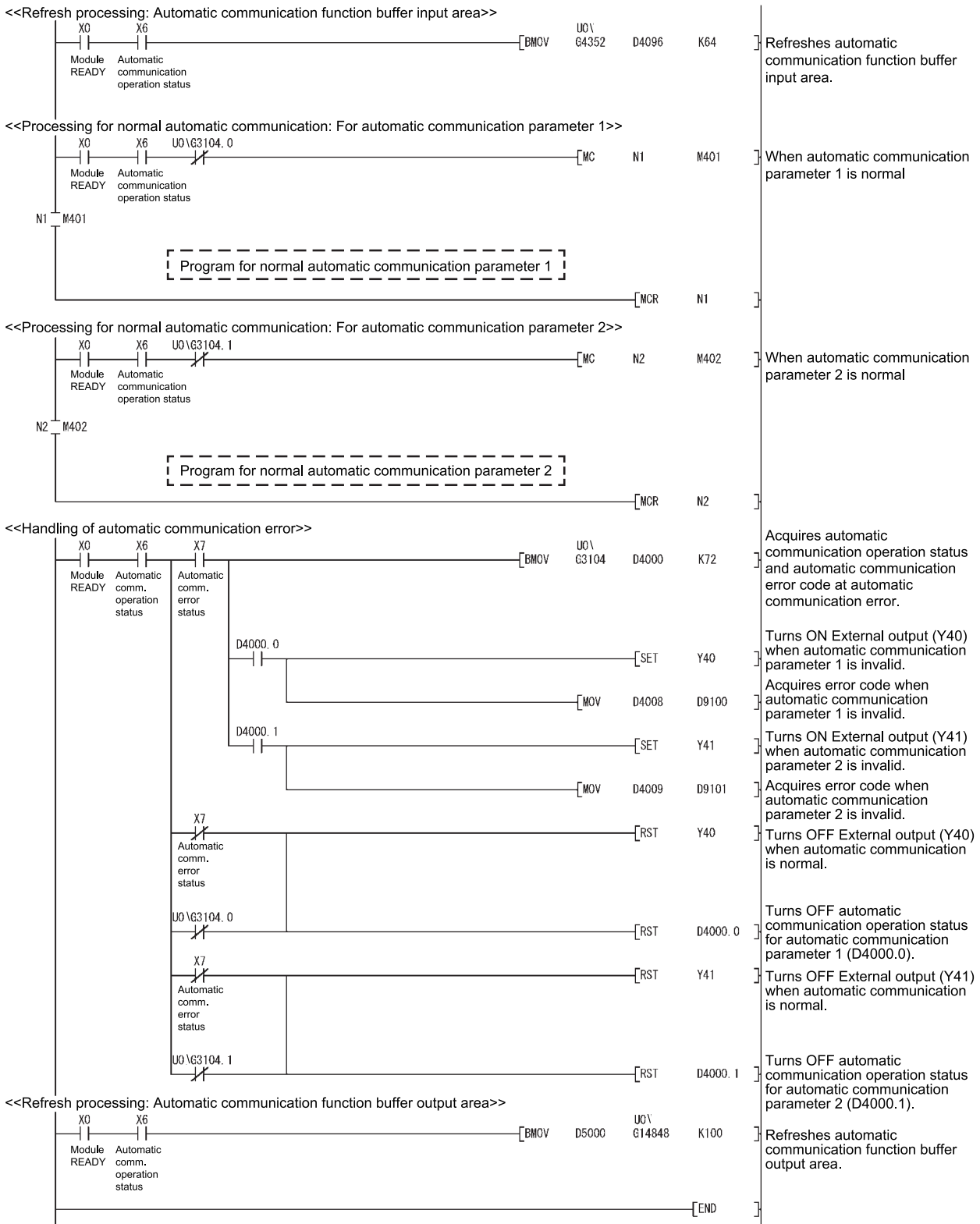

9.3 Program Example for Use in MELSECNET/H Remote I/O Network

9.3.1 System configuration and program conditions

(1) System configuration

A program will be explained as an example to realize the following specifications for the setting target QJ71MT91 (192.1.0.1).

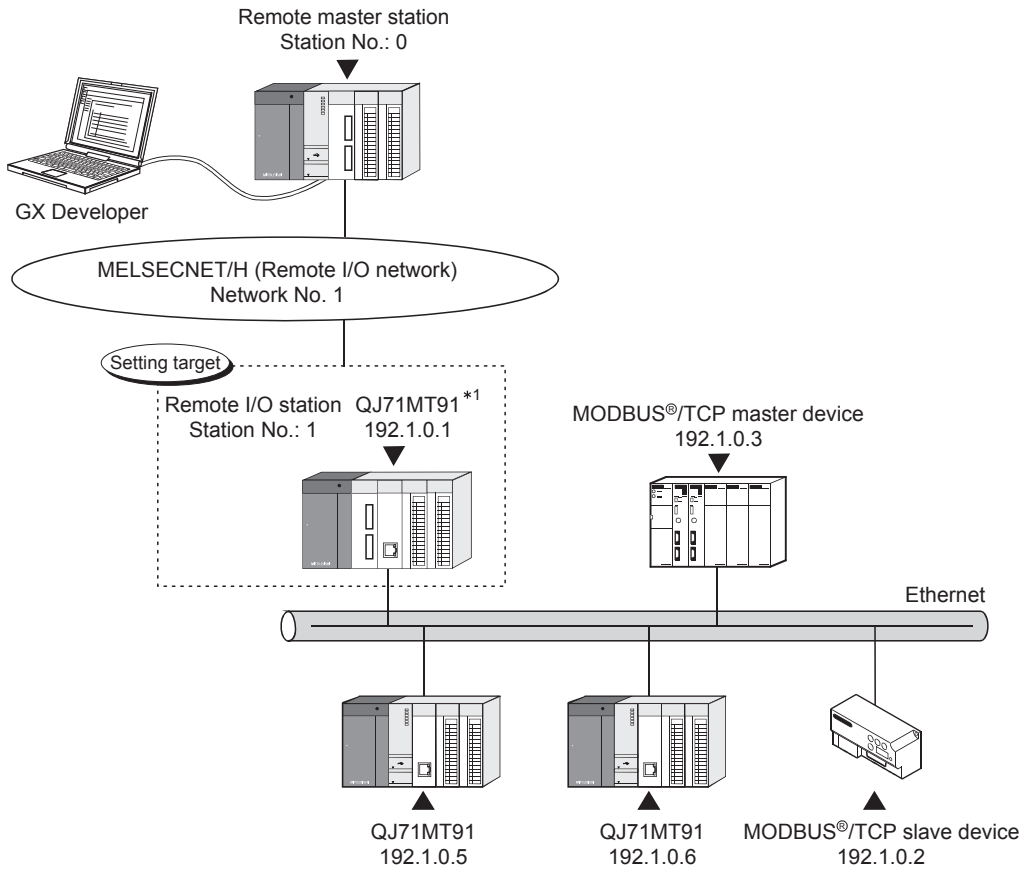

*1: This QJ71MT91 is assumed to be mounted in Slot 0 of the base unit with the head I/O No. set to "0".

(a) Automatic communication function

The setting target QJ71MT91 (192.1.0.1) and MODBUS® /TCP slave device (192.1.0.2) communicate with each other using the automatic communication function.

Set the automatic communication parameters to the setting target QJ71MT91.

[Communication details]

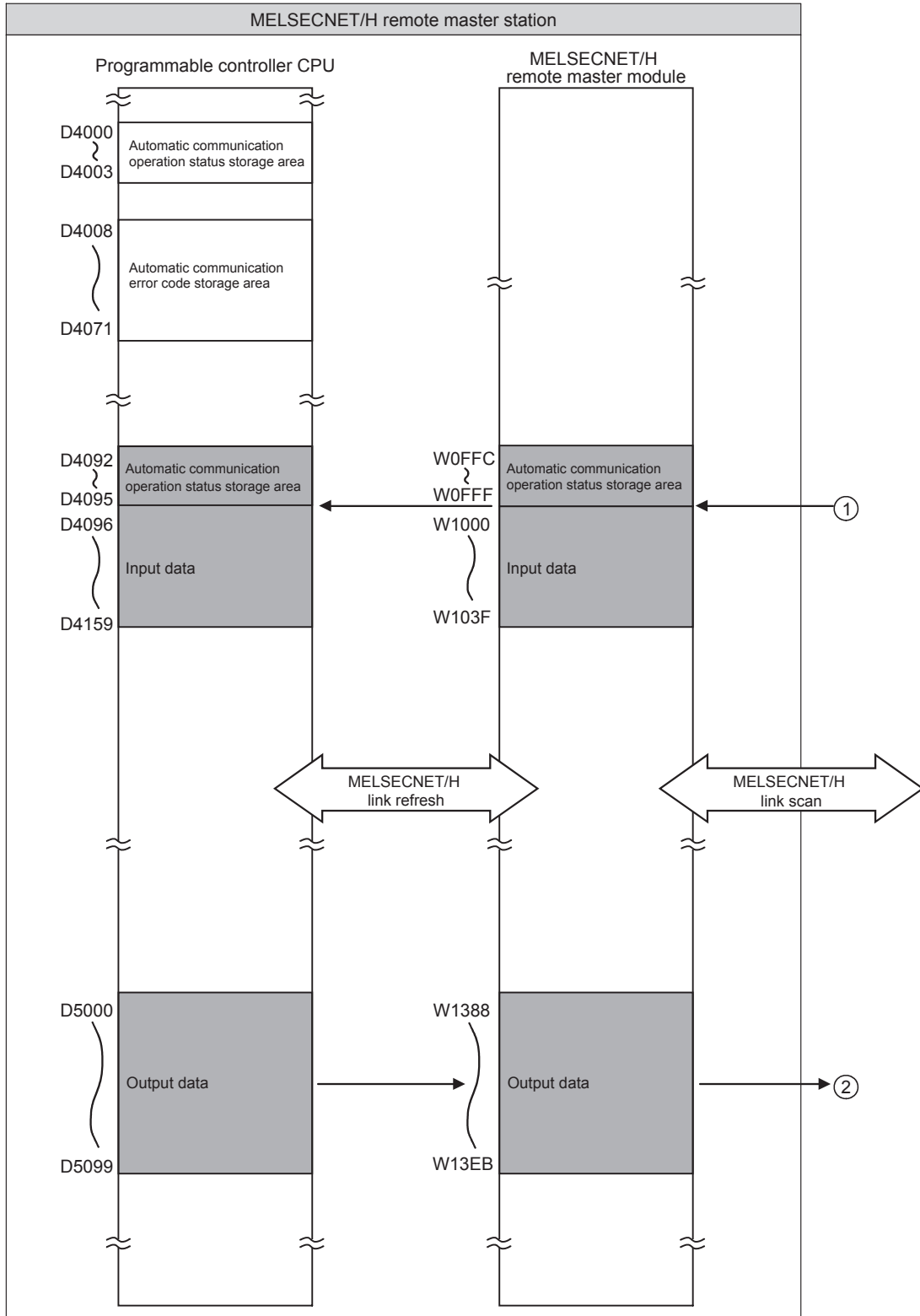

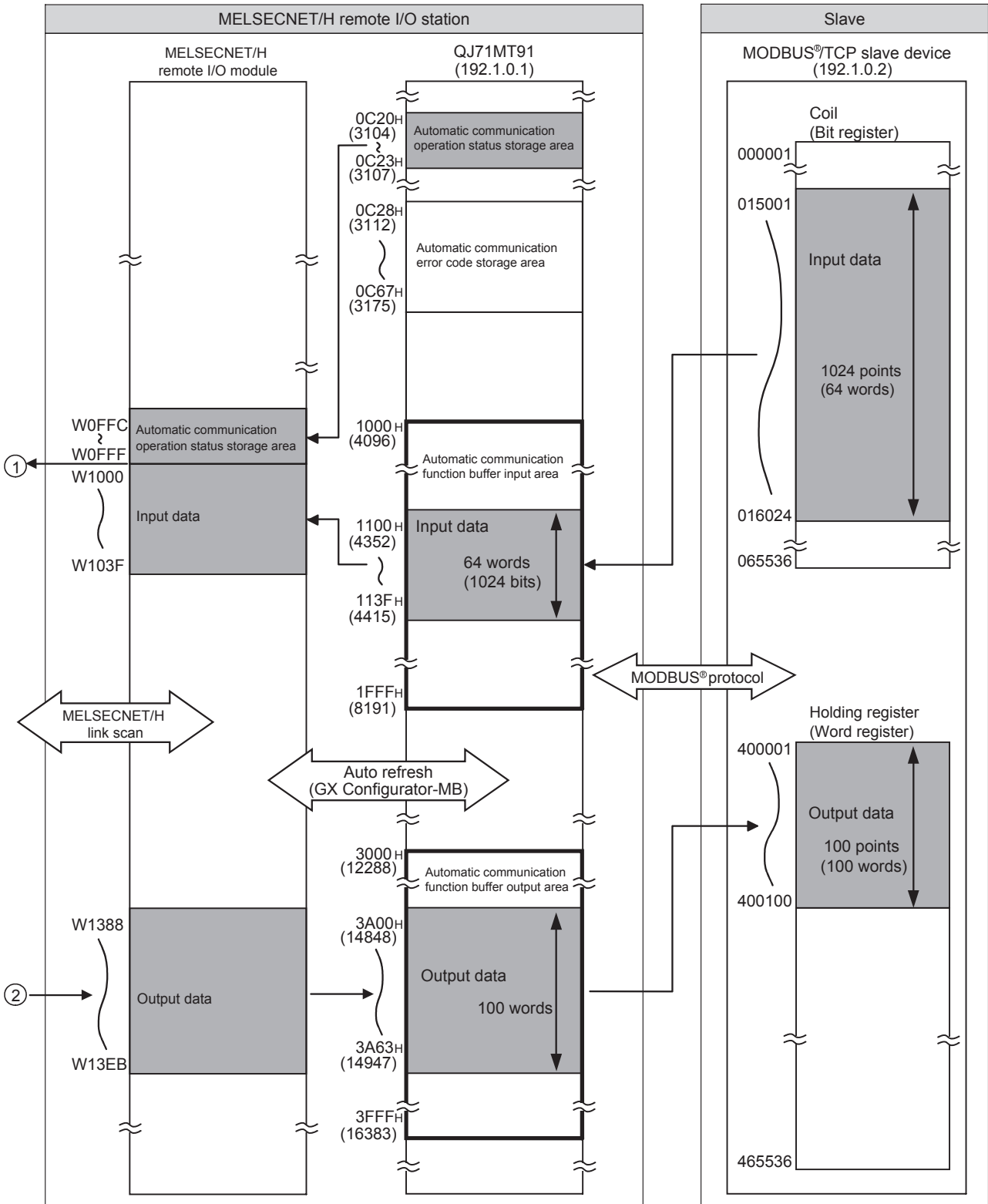

(b) MODBUS[®] device assignment function

The setting target QJ71MT91 (192.1.0.1) uses the MODBUS[®] device assignment function. Set the MODBUS[®] device assignment parameters to the setting target QJ71MT91.

[Assignment details]

Refer to Section 9.2.1 (1) (b) for the assignment details.

(2) Parameter setting details

(a) Basic parameters

Refer to Section 9.2.1 (2) (a) for the basic parameter setting details.

(b) Automatic communication parameters

Refer to Section 9.2.1 (2) (b) for the automatic communication parameter setting details.

(c) MODBUS[®] device assignment parameters

Refer to Section 9.2.1 (2) (c) for the MODBUS[®] device assignment parameter setting details.

(3) Devices used in program

Device Name		Device	Application	
QJ71MT91 input/output	Input	X1000	Module READY	
		X1001	Basic parameter setting, normally completed	
		X1002	Basic parameter setting, error completed	
		X1003	Basic parameter setting existence	
		X1004	Automatic communication parameter setting, normally completed	
		X1005	Automatic communication parameter setting, error completed	
		X1006	Automatic communication operation status	
		X1008	MODBUS [®] device assignment parameter setting, normally completed	
		X1009	MODBUS [®] device assignment parameter setting, error completed	
	Output	Y1001	Basic parameter setting request	
		Y1004	Automatic communication parameter setting request/automatic communication start request	
Y1008		MODBUS [®] device assignment parameter setting request		
External input (command)		X20	Parameter setting command	
External output		Y40	Automatic communication parameter 1 communication error	
		Y41	Automatic communication parameter 2 communication error	
Data register	D0 to D19 D48 D272 to D273 D276 to D279		Basic parameter setting area	
	D512 to D520 D524 to D529 D533 to D535		Automatic communication parameter setting area	
	D2304 to D2307 D2432 to D2435 D2496 to D2499		MODBUS [®] device assignment parameter setting area	
	D3088		Basic parameter error code storage area	
	D3089		Automatic communication parameter error code storage area	
	D3090		Automatic communication parameter setting result storage area	
	D3091		MODBUS [®] device assignment parameter error code storage area	
	D3092		MODBUS [®] device assignment	Error, device type
	D3093		parameter setting result storage area	Error, assigned group No.
	D4000 to D4003		Automatic communication operation status storage area (parameter 1 to 64)	
	D4008 to D4071		Automatic communication error code storage area (parameter 1 to 64)	
	D4092 to D4095		For auto refresh	Automatic communication operation status storage area (parameter 1 to 64)
	D4096 to D4159			Automatic communication function buffer input area
	D5000 to D5099			Automatic communication function buffer output area
	D9100		Automatic communication error code	Automatic communication parameter 1
	D9101			Automatic communication parameter 2

(Continued on next page)

Device Name	Device	Application	
Link special relay	SB20	Module status	
	SB47	Baton pass status (host)	
	SB49	Host data link status	
Link special register	SW70.1	Baton pass status of each station	
	SW74.1	Cyclic transmission status of each station	
	SW78.1	Parameter communication status of each station	
Timer	T0 to T4	For interlock between local and other stations	
Internal relay	M1	For MC instruction	
	M10	For basic parameter setting	REMTO instruction: For instruction completion
	M11		REMTO instruction: For instruction result
	M20		Basic parameter setting command
	M30		REMFR instruction: For instruction completion
	M31		REMFR instruction: For instruction result
	M40		Basic parameter setting command
	M50		REMFR instruction: For instruction completion
	M51		REMFR instruction: For instruction result
	M60		REMFR instruction: For instruction completion
	M61		REMFR instruction: For instruction result
	M100	For automatic communication parameter setting	Automatic communication parameter setting command
	M101		REMTO instruction: For instruction completion
	M102		REMTO instruction: For instruction result
	M111		REMFR instruction: For instruction completion
	M112		REMFR instruction: For instruction result
	M200	For MODBUS® device assignment parameter setting	MODBUS® device assignment parameter setting command
	M201		REMTO instruction: For instruction completion
	M202		REMTO instruction: For instruction result
	M211		REMFR instruction: For instruction completion
	M212		REMFR instruction: For instruction result
	M300	For automatic communication function	REMFR instruction: For instruction completion
	M301		REMFR instruction: For instruction result
	M310		REMTO instruction: For instruction completion
	M311		REMTO instruction: For instruction result
	M320		REMFR instruction: For instruction completion
	M321		REMFR instruction: For instruction result
	M322		For normal processing
	M330		REMFR instruction: For instruction completion
	M331		REMFR instruction: For instruction result
	M401		Automatic communication normal
	M402	For automatic communication parameter 2	

9.3.2 Program using utility package

(1) Intelligent function module switch setting

Set the intelligent function module switches by clicking **Switch setting** on <<I/O assignment>> of GX Developer.

Refer to Section 9.2.2 (1) for the intelligent function module switches.

(2) Parameter setting

Set the parameters from the **Initial setting** screen of GX Configurator-MB.

(a) Basic parameters

Refer to Section 9.2.2 (2) (a) for the basic parameter setting.

(b) Automatic communication parameters

Refer to Section 9.2.2 (2) (b) for the automatic communication parameter setting.

(c) MODBUS[®] device assignment parameters

Refer to Section 9.2.2 (2) (c) for the MODBUS[®] device assignment parameter setting.

(3) Auto refresh setting

Make auto refresh setting from the **Auto refresh setting** screen of GX Configurator-MB.

Set the following items for the program example.

Setting Item	Module side Transfer word count	Module side Buffer offset	PLC side Device
Automatic communication function buffer input area	64	256(100H)	W1000
Automatic communication function buffer output area	100	2560(A00H)	W1388
Automatic communication operation status	—	—	W0FFC

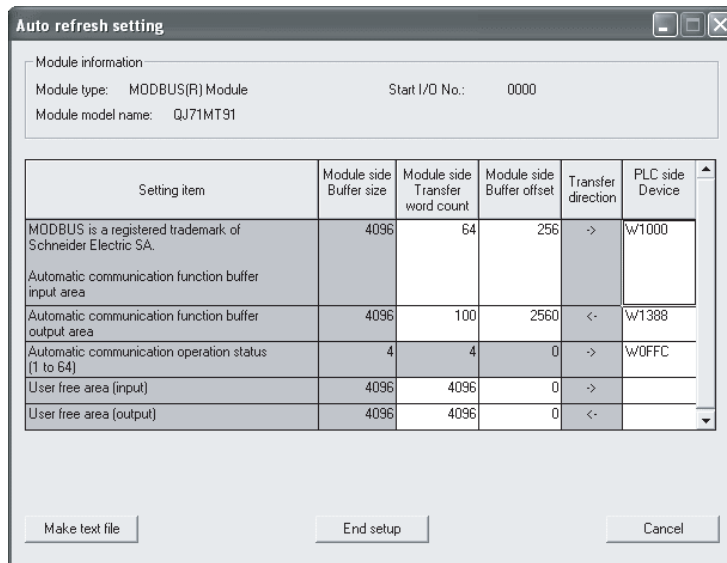

(4) Network parameter setting

Set the network parameters on "Network parameter" of GX Developer.

- 1) Network type : MNET/H (remote master)
- 2) Starting I/O No. : 0000H
- 3) Network No. : 1
- 4) Total number of (slave) stations : 1
- 5) Mode : Online
- 6) Network range assignment
 - XY setting

Station No.	M station -> R station						M station <- R station					
	Y			Y			X			X		
	Points	Start	End	Points	Start	End	Points	Start	End	Points	Start	End
1	32	1000	101F	32	0000	001F	32	1000	101F	32	0000	001F

• BW setting

Station No.	M station -> R station			M station <- R station			M station -> R station			M station <- R station		
	B			B			W			W		
	Points	Start	End	Points	Start	End	Points	Start	End	Points	Start	End
1							100	1388	13EB	68	0FFC	103F

7) Refresh parameters

	Link side					PLC side			
	Dev. name	Points	Start	End		Dev. name	Points	Start	End
Transfer SB	SB	512	0000	01FF	↔	SB	512	0000	01FF
Transfer SW	SW	512	0000	01FF	↔	SW	512	0000	01FF
Random cyclic	LB				↔				
Random cyclic	LW				↔				
Transfer1	LW	8192	0000	1FFF	↔	D	8192	0	8191
Transfer2	LX	32	1000	101F	↔	X	32	1000	101F
Transfer3	LY	32	1000	101F	↔	Y	32	1000	101F
Transfer4					↔				
Transfer5					↔				
Transfer6					↔				

(5) Automatic communication function

- (a) For a program example for normal automatic communication, refer to <<Processing for normal automatic communication>> in (6) (b).
- (b) For a program example for error code acquisition at an automatic communication error, refer to <<Handling of automatic communication error>> in (6) (b).

POINT

The automatic communication error code can be monitored on the "Automatic communication status" screen of GX Configurator-MB.

(6) Program example

(a) Interlock program example for remote master station and remote I/O station

Provide interlocks depending on the link status of the remote master station (local station) and remote I/O station (other station).

The following example shows communication program interlocks using the link status (SB47, SB49) of the remote master station and the link status (SW70 bit 0, SW74 bit 0, SW78 bit 0) of the remote I/O station (station No. 1).

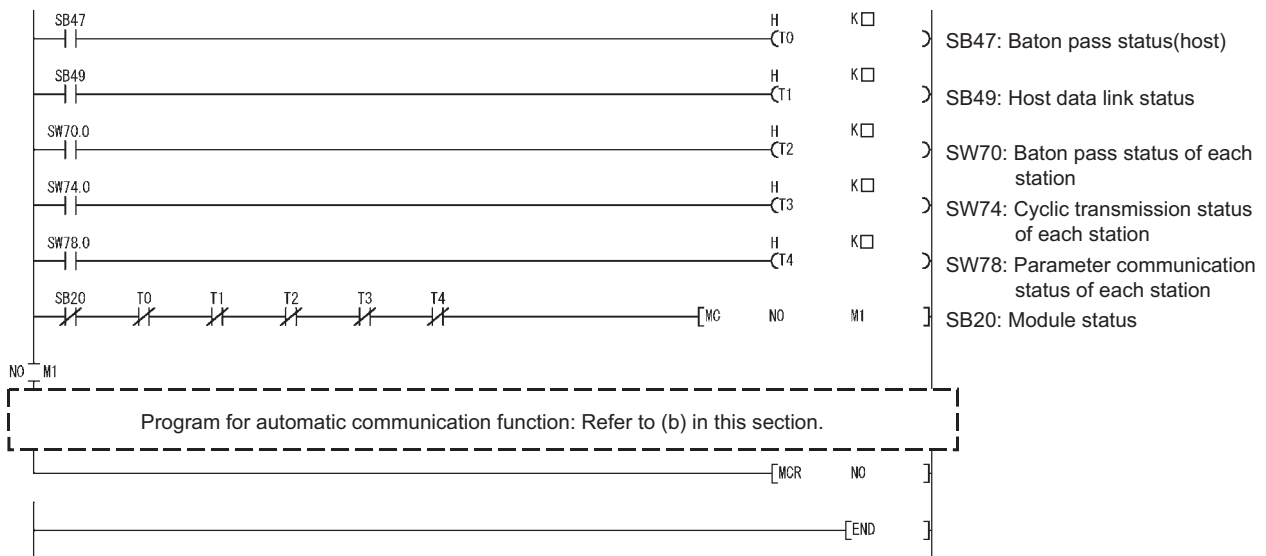

Set the following value in the timer constant K□.

Baton pass status (T0, T2)	(Sequence scan time × 4) or more
Cyclic transmission status Parameter communication status (T1, T3, T4)	(Sequence scan time × 3) or more

Reason: To prevent control from stopping even if the network detects an instantaneous error due to a cable problem, noise or other condition.

Note that "× 4" and "× 3" represent standard values.

POINT

For details of the interlock program for the remote master station and remote I/O station of MELSECNET/H, refer to the "Q Corresponding MELSECNET/H Network System Reference Manual (Remote I/O Network)".

(b) Program example for automatic communication function

POINT
 After execution of the REMTO/REMFR instruction, it requires several scans until read/write of actual data is completed.

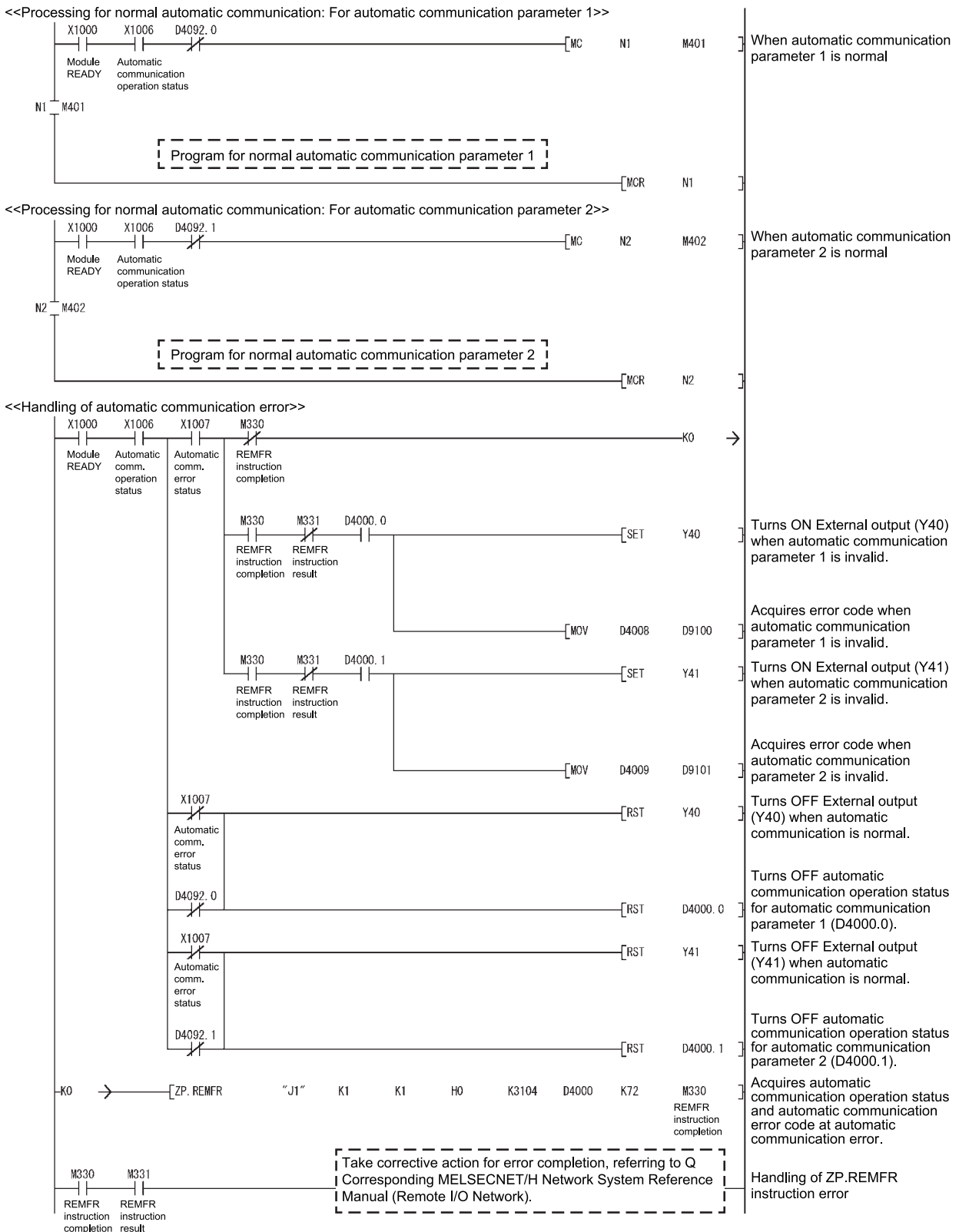

9.3.3 Program without using utility package

(1) Intelligent function module switch setting

Set the intelligent function module switches by clicking Switch setting on <<I/O assignment>> of GX Developer.

Refer to Section 9.2.3 (1) for the intelligent function module switches.

(2) Parameter setting

Set the parameters using a sequence program.

Parameter setting can be omitted under the following conditions.

Parameter	Parameter Setting Omitting Condition	
	Condition	Setting method
Basic parameters	Use the default parameters. (* 1)	With the intelligent function module switch 2, set the basic parameter starting method (bit 0) to "0: Start with the default parameters". (Refer to Section 9.2.3 (1).)
Automatic communication parameters	Do not use the automatic communication function (master function).	No need to set.
MODBUS [®] device assignment parameters	Use the default parameters. (*2)	With the intelligent function module switch 2, set the MODBUS [®] device assignment parameter starting method (bit 1) to "0: Start with the default parameters". (Refer to 9.2.3 (1).)
	Do not use the MODBUS [®] device assignment function (slave function).	No need to set.

*1: To utilize the basic parameters with the initial values (refer to Section 7.2.1), it is recommended to use the default parameters.

*2: When the device assignment of the CPU is not changed, it is recommended to use the default parameters.

(a) Basic parameters

Execute Basic parameter setting request (Y1001) after writing the basic parameters to the buffer memory by the REMOTO instruction.

For a program example for basic parameter setting, refer to <<Basic parameter setting>> in (6) (b) in this section.

(b) Automatic communication parameters

Execute Automatic communication parameter setting request (Y1004) after writing the automatic communication parameters to the buffer memory by the REMOTO instruction.

For a program example for automatic communication parameter setting, refer to <<Automatic communication parameter setting>> in (6) (b) in this section.

(c) MODBUS[®] device assignment parameters

Execute MODBUS[®] device assignment parameter setting request (Y1008) after writing the MODBUS[®] device assignment parameters to the buffer memory by the REMOTO instruction.

For a program example for MODBUS[®] device assignment parameter setting, refer to <<MODBUS device assignment parameter setting>> in (6) (b) in this section.

(3) Network parameter setting

Set the network parameters on "Network parameter" of GX Developer.

- 1) Network type : MNET/H (remote master)
- 2) Starting I/O No. : 0000_H
- 3) Network No. : 1
- 4) Total number of (slave) stations : 1
- 5) Mode : Online
- 6) Network range assignment
 - XY setting

Station No.	M station → R station						M station ← R station					
	Y			Y			X			X		
	Points	Start	End	Points	Start	End	Points	Start	End	Points	Start	End
1	32	1000	101F	32	0000	001F	32	1000	101F	32	0000	001F

7) Refresh parameters

	Link side						PLC side				
	Dev. name	Points	Start	End	Dev. name		Points	Start	End		
Transfer SB	SB	512	0000	01FF	↔	SB	512	0000	01FF		
Transfer SW	SW	512	0000	01FF	↔	SW	512	0000	01FF		
Random cyclic	LB				↔						
Random cyclic	LW				↔						
Transfer1	LX	32	1000	101F	↔	X	32	1000	101F		
Transfer2	LY	32	1000	101F	↔	Y	32	1000	101F		
Transfer3					↔						
Transfer4					↔						
Transfer5					↔						
Transfer6					↔						

(4) Refresh setting

For the processing equivalent to auto refresh setting (GX Configurator-MB), refer to <<Refresh processing>> in (6) (b).

(5) Automatic communication function

- (a) For a program example for normal automatic communication, refer to <<Processing for normal automatic communication>> in (6) (b).
- (b) For a program example for error code acquisition at an automatic communication error, refer to <<Handling of automatic communication error>> in (6) (b).

(6) Program example

(a) Interlock program example for remote master station and remote I/O station

Provide interlocks depending on the link status of the remote master station (local station) and remote I/O station (other station).

The following example shows communication program interlocks using the link status (SB47, SB49) of the remote master station and the link status (SW70 bit 0, SW74 bit 0, SW78 bit 0) of the remote I/O station (station No. 1).

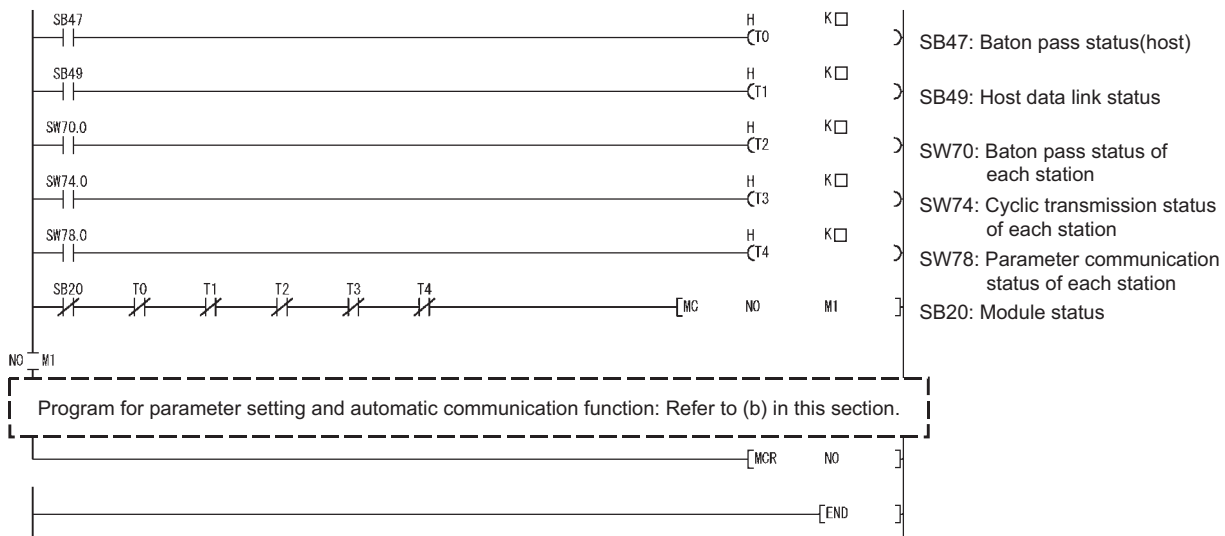

Set the following value in the timer constant K□.

Baton pass status (T0, T2)	(Sequence scan time × 4) or more
Cyclic transmission status Parameter communication status (T1, T3, T4)	(Sequence scan time × 3) or more

Reason: To prevent control from stopping even if the network detects an instantaneous error due to a cable problem, noise or other condition.

Note that "× 4" and "× 3" represent standard values.

POINT

For details of the interlock program for the remote master station and remote I/O station of MELSECNET/H, refer to the "Q Corresponding MELSECNET/H Network System Reference Manual (Remote I/O Network)".

(b) Program example for parameter setting and automatic communication function

POINT
 After execution of the REMTO/REMFR instruction, it requires several scans until read/write of actual data is completed.

<<Basic parameter setting>>

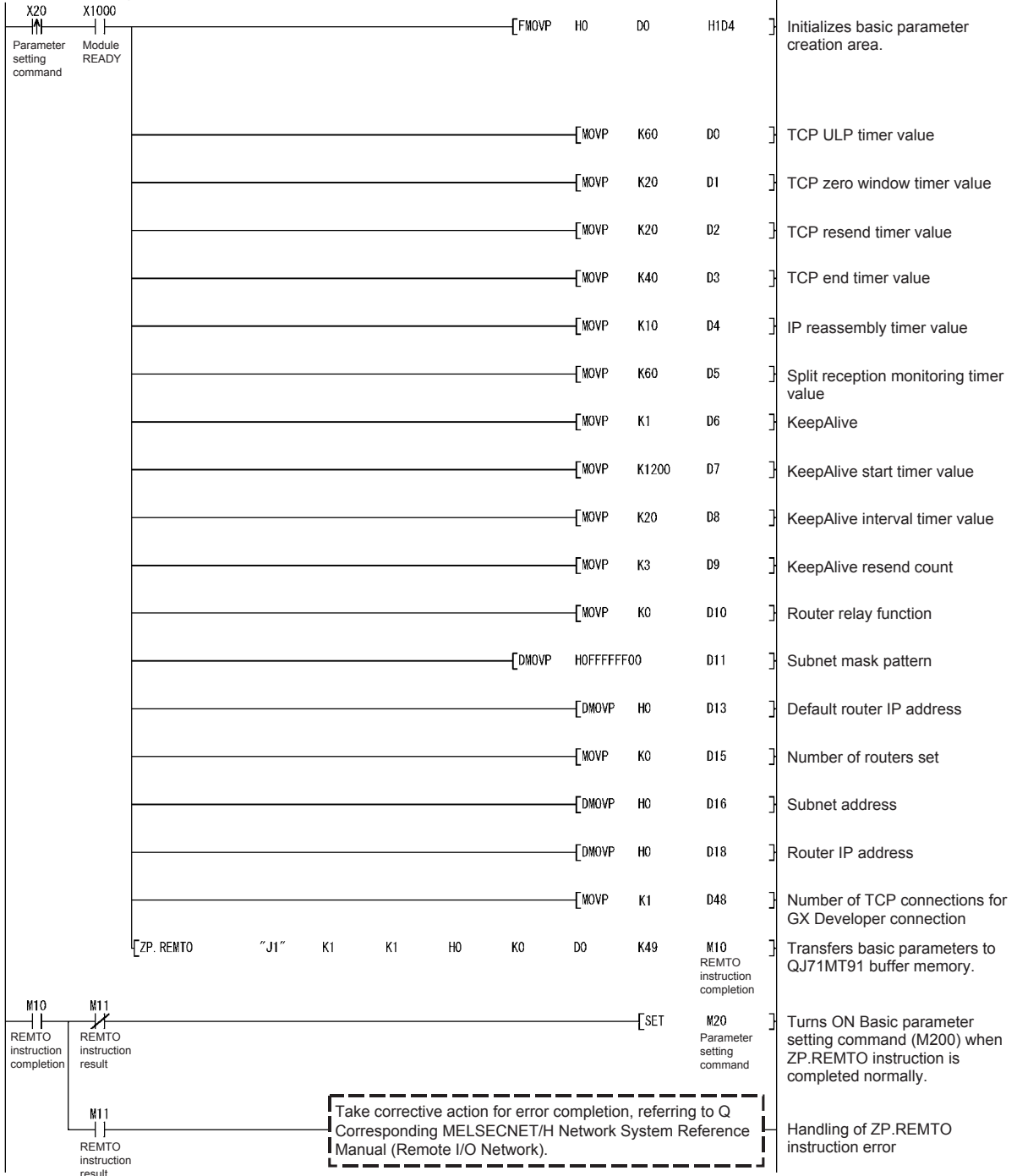

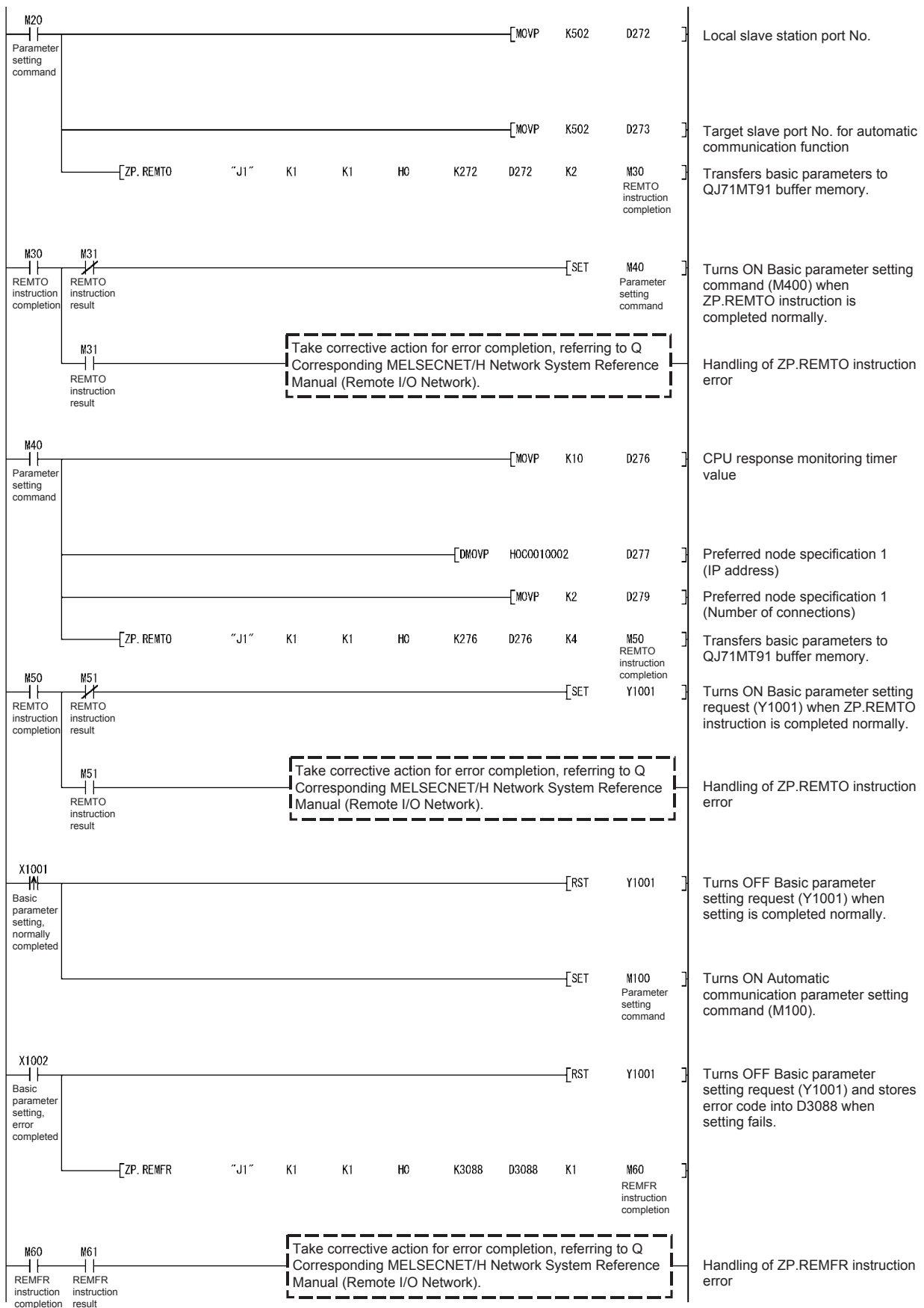

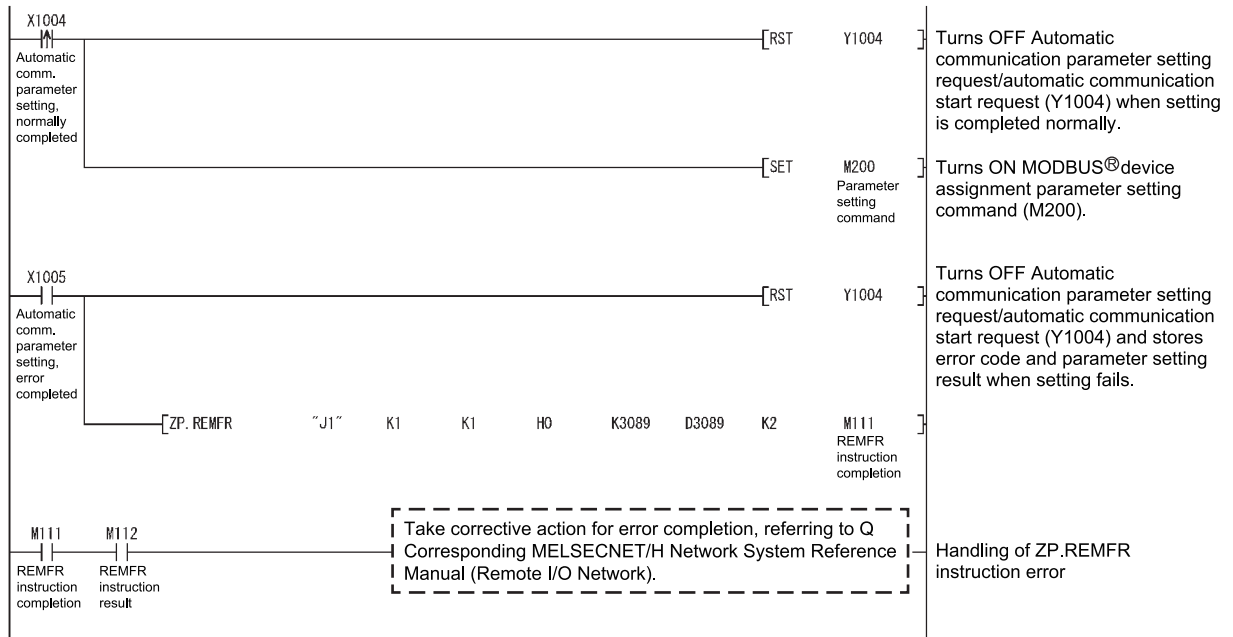

<<MODBUS device assignment parameter setting>>

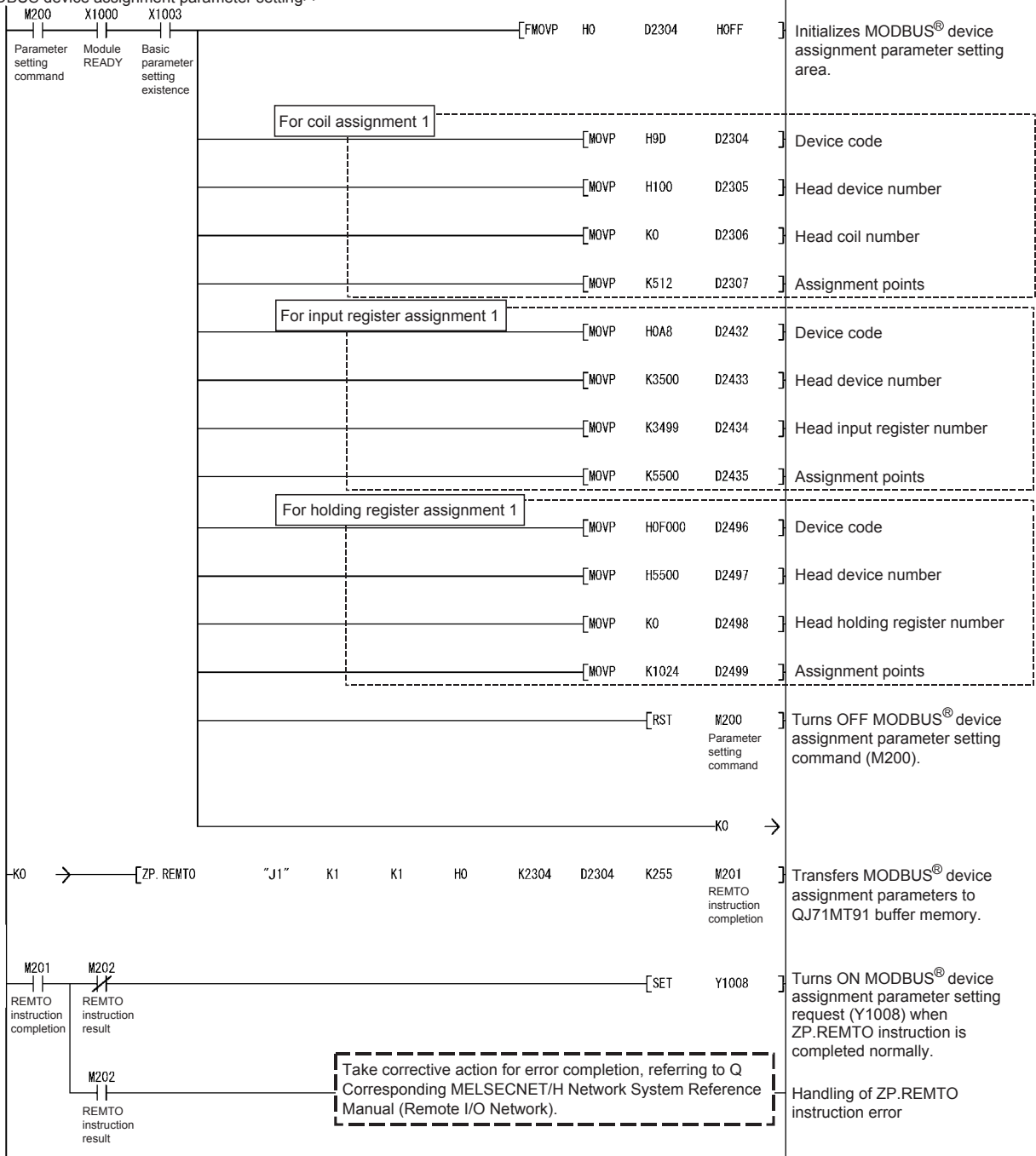

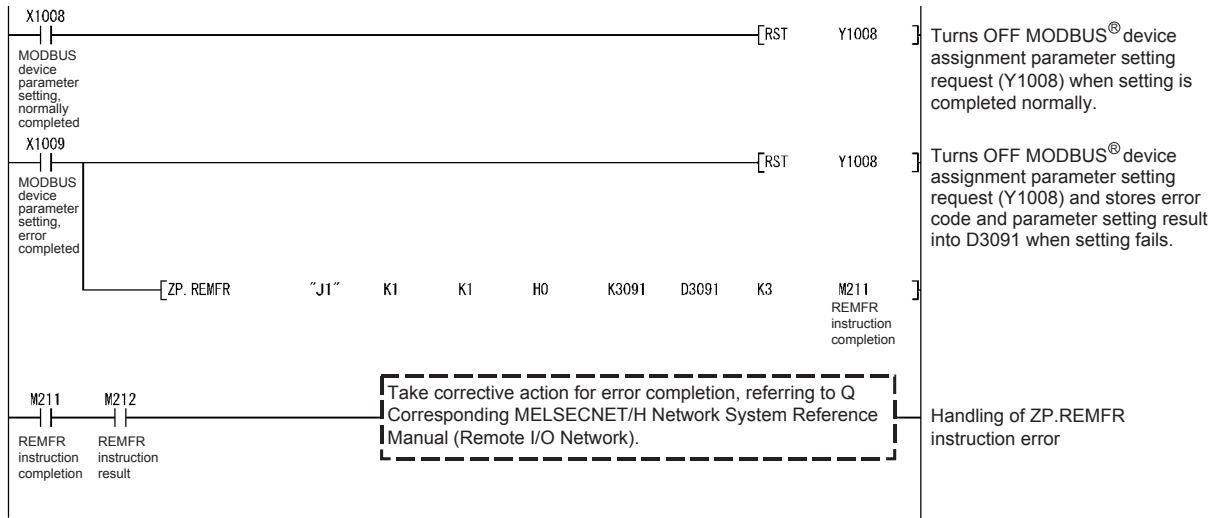

<<Refresh processing: Automatic communication function buffer input area>>

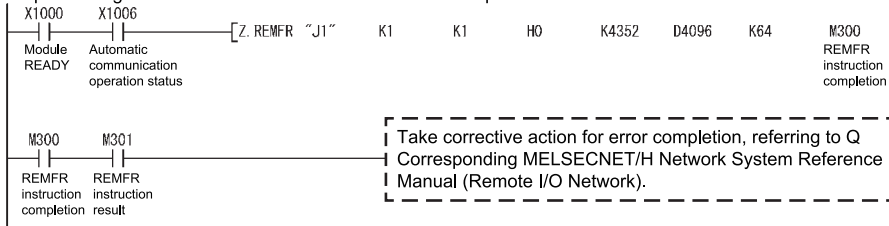

Refreshes automatic communication function buffer input area.
Handling of Z.REMFR instruction error

<<Refresh processing: Automatic communication operation status>>

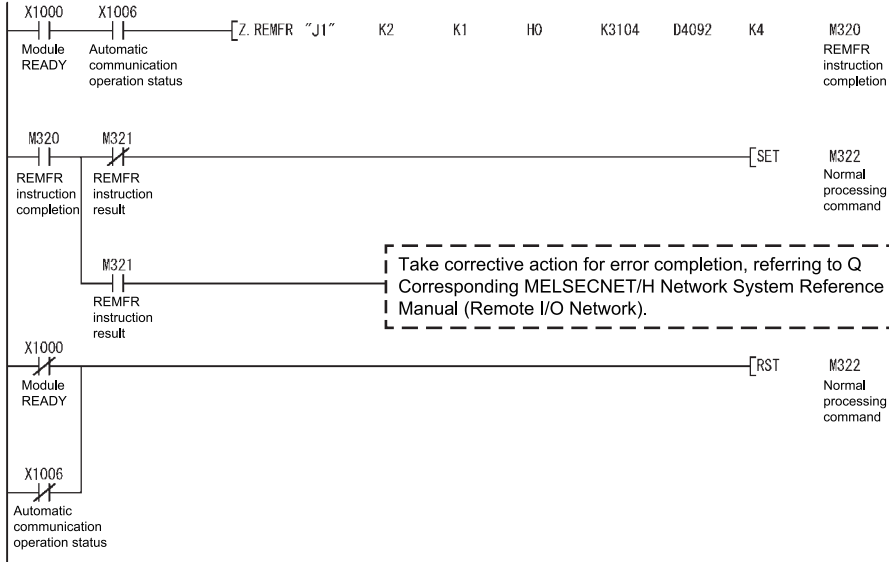

Refreshes automatic communication operation status storage area.
Turns ON Normal processing command (M322) after acquiring automatic communication operation status storage area data.
Handling of Z.REMFR instruction error
Turns OFF Normal processing command (M322) when Module READY (X1000) or Automatic communication operation status (X1006) is OFF.

<<Processing for normal automatic communication: For automatic communication parameter 1>>

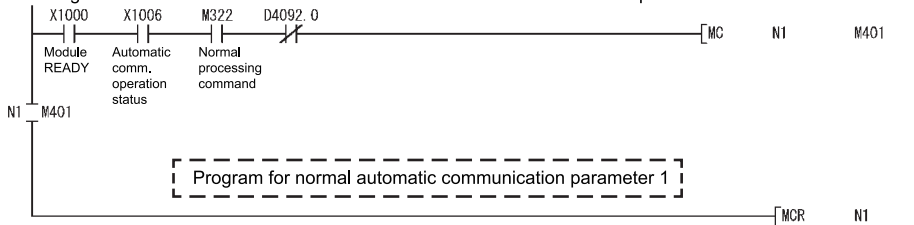

When automatic communication parameter 1 is normal

<<Processing for normal automatic communication: For automatic communication parameter 2>>

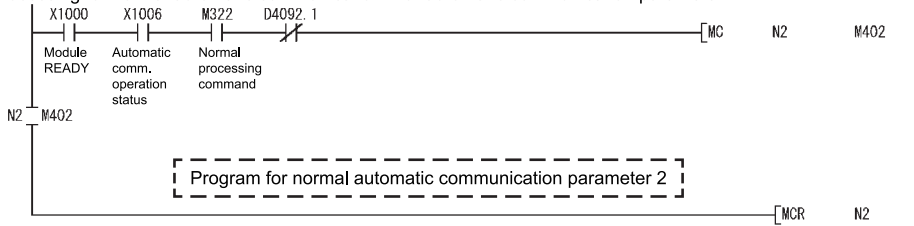

When automatic communication parameter 2 is normal

<<Handling of automatic communication error>>

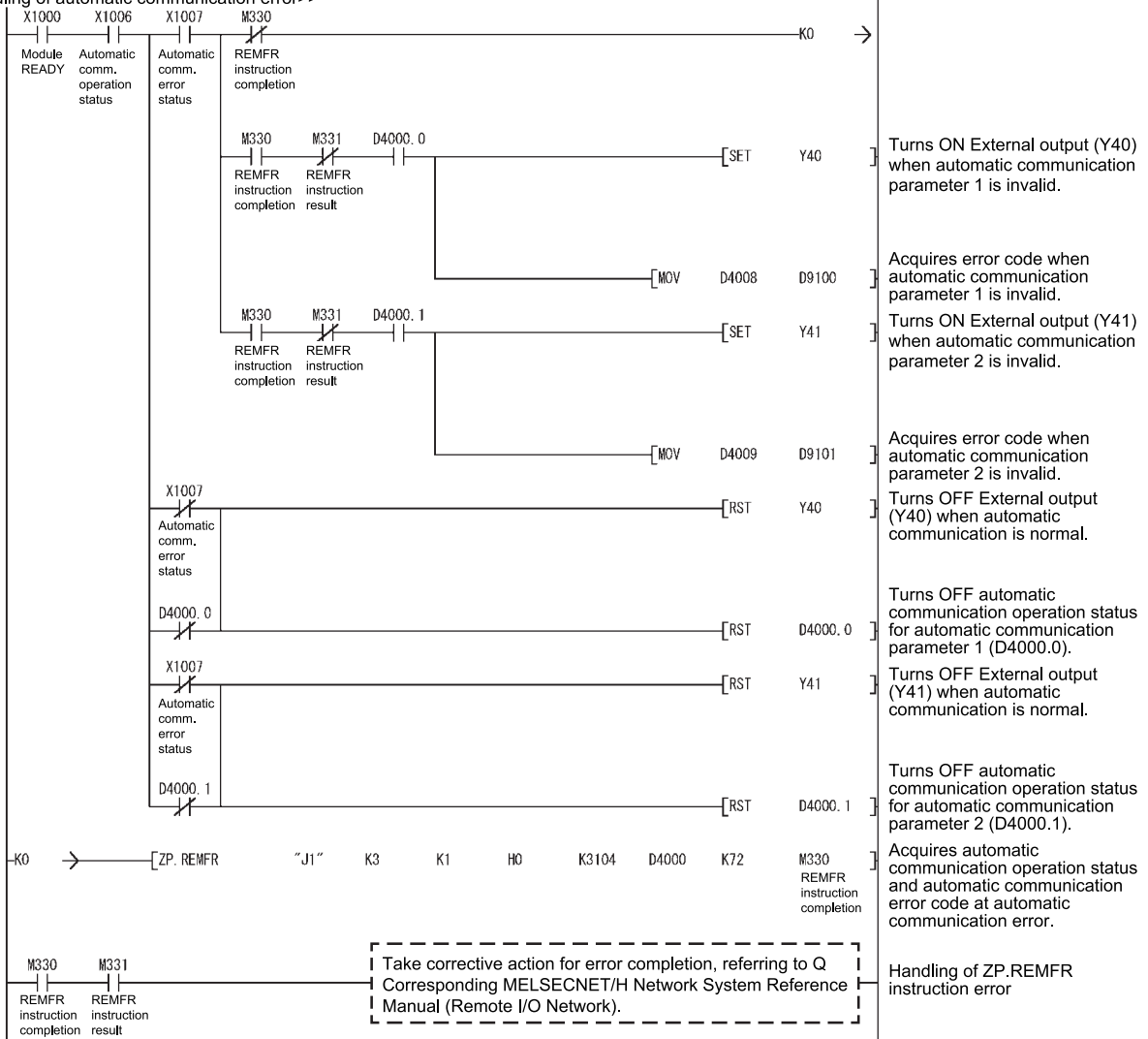

<<Refresh processing: Automatic communication function buffer output area>>

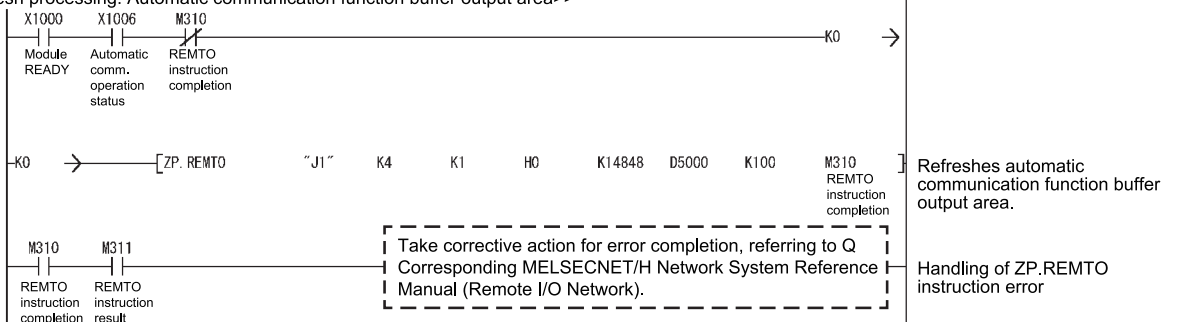

10 DEDICATED INSTRUCTIONS

The dedicated instructions make programming easy for use of the intelligent function module functions.

10.1 Dedicated Instruction List and Available Devices

(1) Dedicated instruction list

The following table indicates a list of dedicated instructions supported by the QJ71MT91.

Dedicated Instruction	Description	Reference
MBRW	Reads and writes the MODBUS® device data from and to the slave.	Section 10.2
MBREQ	Communicates with the slave in the request message format of any PDU (protocol data unit).	Section 10.3

Interlock for dedicated instruction execution

Execute the dedicated instruction with the I/O signals in the following status.

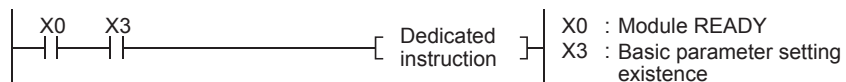

POINT
Until completion of the dedicated instruction execution, do not change the data (control data, argument, etc.) specified for the dedicated instruction.

(2) Available devices

The following devices are available for the dedicated instructions:

Internal devices		File register
Bit ^{*1}	Word	
X, Y, M, L, F, V, B	T, ST, C, D, W	R, ZR

*1: Word device bit designation can be used as bit data.

Word device bit designation is done by designating **Word device** . **Bit No.** .

(Designation of bit numbers is done in hexadecimal.)

For example, bit 10 of D0 is designated as **D0.A** .

However, there can be no bit designation for timers (T), retentive timers (ST) and counters (C).

10.2 Z(P).MBRW

With this instruction, the MODBUS® device data are read from and written to the slave.

Set Data	Usable Devices									
	Internal device (System, user)		File register	Link direct device J □ \ □		Intelligent function module device U □ \ G □	Index register Zn	Constant		Others
	Bit	Word		Bit	Word			K, H	\$	
(S1)	—	○					—			
(D1)	—	○					—			
(S2)	—	○					—			
(D2)		○					—			

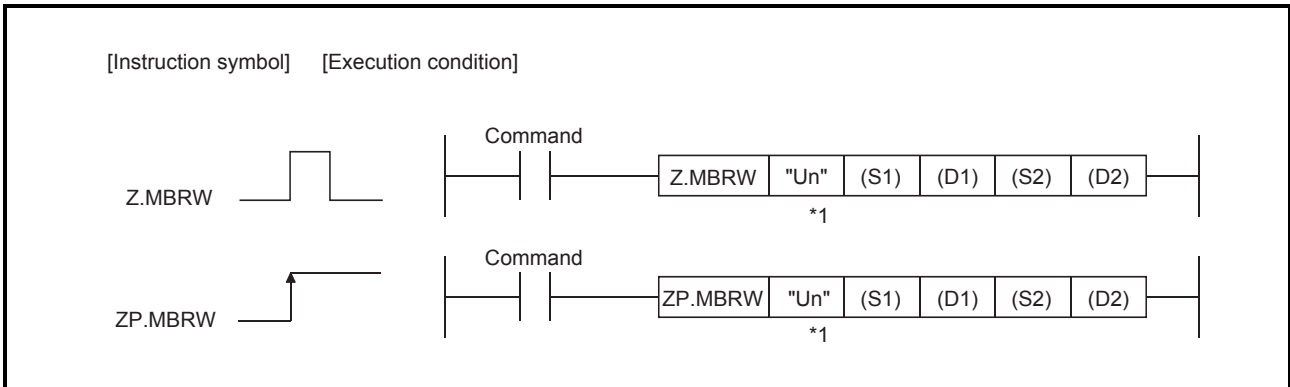

*1: If the originating station is a Basic model QCPU (function version B or later), or Universal model QCPU, "" (double quotation) of the first argument can be omitted.

Set data

Set data	Setting	Setting Side *2	Data Type
"Un"	Head I/O number of module (00H to FEH: Upper 2 digits of the I/O number in 3-digit notation)	User	BIN 16 bits
(S1)	Head number of device where control data are stored	User, system	
(D1) *3	Read data storing device	System	
(S2) *3	Write data storing device	User	Bit
(D2)	Device turned ON one scan on completion of the instruction (D2)+1 also turns ON for error completion.	System	

*2: The setting side is as described below.

- User : Data are set by the user before dedicated instruction execution.
- System : The programmable controller CPU stores the result of dedicated instruction execution.

*3: Specify a dummy device if "00H: No specification" is selected in the Type specification of the target MODBUS® device ((S1)+8).

The local device and program-based file register are not available as the devices used for set data.

Control data

Device	Item	Set Data	Setting Range	Setting Side ²⁾																						
(S1)+0	Execution type	<div style="text-align: center;"> <table border="1" style="margin: auto;"> <tr> <td style="width: 100px;">b15</td> <td style="width: 100px;">to</td> <td style="width: 100px;">b1</td> <td style="width: 100px;">b0</td> </tr> <tr> <td style="text-align: center;">0</td> <td style="text-align: center;">to</td> <td style="text-align: center;">0</td> <td style="text-align: center;">1)</td> </tr> </table> </div> <p>1) Close option (Bit 0) Set whether a TCP connection will be closed or not after instruction completion. 0: TCP connection is not closed after instruction completion. 1: TCP connection is closed after instruction completion.</p>	b15	to	b1	b0	0	to	0	1)	0, 1	User														
b15	to	b1	b0																							
0	to	0	1)																							
(S1)+1	Complete condition	A condition when instruction is completed is stored. 0: Normal completion Other than 0: Error completion (error code) Refer to Section 11.3.3 for details of the error code.	—	System																						
(S1)+2	MODBUS [®] exception code	An exception code from the slave is stored. 0: Slave processing normally completed Other than 0: Slave processing completed with an error (exception code) Refer to Section 11.3.2 for details of the exception code.	—	System																						
(S1)+3	Target IP address	Set the IP address of the target slave. IP address: 192. 1. 0. 2	Refer to *1	User																						
(S1)+4																										
(S1)+5	Module ID	Set when a request message is sent to the slave without the MODBUS [®] /TCP interface via the MODBUS [®] serial gateway, etc. When the destination of the request message is the MODBUS [®] serial gateway, the set values are as described below. 0: Broadcast 1 to 247: Station number of MODBUS [®] serial slave *: Set "255" when the destination of the request message is the slave having the MODBUS [®] /TCP interface.	0 to 255	User																						
(S1)+6	Target slave port No.	Specify the port No. of the target slave. 0: Sent to No. 502 1 to 65535: Sent to the set port No.	0 1 to 65535 (*3)	User																						
(S1)+7	Response monitoring timer value	Specify the time for monitoring a response from the target device (slave). (500ms increments) 0: 60 (30s) 2 to 2400: Set value (Response monitoring timer value = set value × 500ms)	0 2 to 2400	User																						
(S1)+8	Type specification of the target MODBUS [®] device	Specify the types of the read/write target MODBUS [®] devices. *3 <div style="text-align: center;"> <table border="1" style="margin: auto;"> <tr> <td style="width: 100px;">b15</td> <td style="width: 100px;">b8</td> <td style="width: 100px;">b7</td> <td style="width: 100px;">b0</td> </tr> <tr> <td colspan="2" style="text-align: center;">Read target</td> <td colspan="2" style="text-align: center;">Write target</td> </tr> </table> <table border="1" style="margin: auto;"> <thead> <tr> <th>Set value</th> <th>Target MODBUS[®] device type</th> </tr> </thead> <tbody> <tr> <td>00H</td> <td>No specification</td> </tr> <tr> <td>01H</td> <td>Coil</td> </tr> <tr> <td>02H</td> <td>Input</td> </tr> <tr> <td>04H</td> <td>Input register</td> </tr> <tr> <td>05H</td> <td>Holding register</td> </tr> <tr> <td>07H</td> <td>Extended file register</td> </tr> </tbody> </table> </div>	b15	b8	b7	b0	Read target		Write target		Set value	Target MODBUS [®] device type	00H	No specification	01H	Coil	02H	Input	04H	Input register	05H	Holding register	07H	Extended file register	0001H 0005H 0007H 0100H 0200H 0400H 0500H 0505H 0700H	User
b15	b8	b7	b0																							
Read target		Write target																								
Set value	Target MODBUS [®] device type																									
00H	No specification																									
01H	Coil																									
02H	Input																									
04H	Input register																									
05H	Holding register																									
07H	Extended file register																									

Device	Item	Set Data	Setting Range	Setting Side ^{*2}								
(S1)+9	Corresponding file number	Specify the file number when the target MODBUS [®] device is the extended file register.	0 to 65535 (*3, *4)	User								
(S1)+10	Target MODBUS [®] device head number	Specify the head number of the read target MODBUS [®] device. As the device head number, specify the lower 5 digits of "(actual device number) - 1". (With the exception of the file number and device number of the extended file register) (Example) Specify "31" when accessing the input 100032.	0 to 65535 (*3, *4)	User								
(S1)+11	Read setting Access points	Set the read points of the MODBUS [®] device. Use the following unit to set the access points. <table border="1" style="width: 100%; border-collapse: collapse;"> <thead> <tr> <th>Type specification of the target MODBUS[®] device</th> <th>Setting unit</th> <th>Access points that can be set</th> </tr> </thead> <tbody> <tr> <td>01H: Coil 02H: Input</td> <td>Bit</td> <td rowspan="4" style="text-align: center; vertical-align: middle;">Refer to *6.</td> </tr> <tr> <td>04H: Input register 05H: Holding register 07H: Extended file register</td> <td>Word</td> </tr> </tbody> </table>	Type specification of the target MODBUS [®] device	Setting unit	Access points that can be set	01H: Coil 02H: Input	Bit	Refer to *6.	04H: Input register 05H: Holding register 07H: Extended file register	Word	0 to 2000 (*4)	User
Type specification of the target MODBUS [®] device	Setting unit	Access points that can be set										
01H: Coil 02H: Input	Bit	Refer to *6.										
04H: Input register 05H: Holding register 07H: Extended file register	Word											
(S1)+12	Read data storage size		Set the word size of the read data stored in the argument (D1) and later.	—	System							
(S1)+13	Corresponding file number		Specify the file number when the target MODBUS [®] device is the extended file register.	0 to 65535 (*3, *5)	User							
(S1)+14	Target MODBUS [®] device head number	Specify the head number of the write target MODBUS [®] device. As the device head number, specify the lower 5 digits of "(actual device number) - 1". (With the exception of the file number and device number of the extended file register) (Example) Specify "31" when accessing the input 400032.	0 to 65535 (*3, *5)	User								
(S1)+15	Write setting Access points	Set the write points of the MODBUS [®] device. Use the following unit to set the access points. <table border="1" style="width: 100%; border-collapse: collapse;"> <thead> <tr> <th>Type specification of the target MODBUS[®] device</th> <th>Setting</th> <th>Access points that can be set</th> </tr> </thead> <tbody> <tr> <td>01H: Coil 02H: Input</td> <td>Bit</td> <td rowspan="4" style="text-align: center; vertical-align: middle;">Refer to *6.</td> </tr> <tr> <td>04H: Input register 05H: Holding register 07H: Extended file register</td> <td>Word</td> </tr> </tbody> </table>	Type specification of the target MODBUS [®] device	Setting	Access points that can be set	01H: Coil 02H: Input	Bit	Refer to *6.	04H: Input register 05H: Holding register 07H: Extended file register	Word	0 to 1968 (*5)	User
Type specification of the target MODBUS [®] device	Setting	Access points that can be set										
01H: Coil 02H: Input	Bit	Refer to *6.										
04H: Input register 05H: Holding register 07H: Extended file register	Word											
(S1)+16	Write data storage size		Set the word size of the write data stored in the argument (S2) and later. Set "1" when performing read only. When the access target MODBUS [®] device (type specification of the target MODBUS [®] device) is "01H: Coil" or "02H: Input", pay attention to the following. • Set the "access points/16 (rounded up to the nearest integer)". • When the number of write points is a fraction, the excess area is ignored. (Refer to (3) in POINT on the next page.)	1 to 125	User							

- *1: Set the value that satisfies the following conditions.
Condition 1: The IP address class is any of A, B and C.
Condition 2: The host address bits are not all "0" or all "1".
- *2: The setting side is as described below.
User: Data are set by the user before dedicated instruction execution.
System: The programmable controller CPU stores the result of dedicated instruction execution.
- *3: When specifying a value of 32768 (8000H) or more in a sequence program, set the value in hexadecimal.

- *4: Set "0" for the case of write only.
- *5: Set "0" for the case of read only.
- *6: The combinations of the read and write targets that can be set in the target MODBUS® device type setting and the setting ranges of the access points are as indicated in the following table.

Type Specification of the Target MODBUS® Device			Function Code		Access Points Setting Range	
Set values	Read target	Write target			Read points	Write point
0100H	Coil	No specification	01	Read coils	1 to 2000	—
0200H	Input		02	Read discrete inputs	1 to 2000	—
0400H	Input register		04	Read input registers	1 to 125	—
0500H	Holding register		03	Read holding registers	1 to 125	—
0700H	Extended file register		20	Read file record	1 to 124	—
0001H	No specification	Coil	15	Write multiple coils	—	1 to 1968
0005H		Holding register	16	Write multiple registers	—	1 to 123
0007H		Extended file register	21	Write file record	—	1 to 122
0505H	Holding register	Holding register	23	Read/write multiple registers	1 to 125	1 to 121

- 1) No combination setting other than the above is allowed for the type specification of the target MODBUS® device ((S1)+8).
- 2) Simultaneous execution of read and write with a single instruction is allowed only for 0505H (Read/Write Multiple Registers).
- 3) Read file record (FC: 20) and Write file record (FC: 21) allows access to multiple areas in one communication, however, only one area is accessible in one communication when using this dedicated instruction.

POINT

(1) When the close option setting of the execution type ((S1)+0) is "TCP connection is closed after instruction completion", TCP connection is closed after the dedicated instruction has been completed and the completion device (D2) has turned ON. If the dedicated instruction is executed again for the same target device during this TCP connection closing processing, it is completed with an error. When the execution interval of the dedicated instruction for the same target device is short, set the close option to "TCP connection is not closed after instruction completion".

(2) Specify "(device number) - 1" as the device number. However, this does not apply to the file number and device number specified for the Read/write file record.

(3) When access is made to the bit device (coil, input) of the slave, the fraction bit is handled as described below.

[Read]
 When the read access points are 35 points

[Write]
 When the write access points are 5 points

Function

- (1) MODBUS[®] device data are read from and written to the slave specified in the target IP address of the control data.
- (2) The processing used in the automatic communication function can be performed from a sequence program at any timing.
- (3) A maximum of eight MBRW instructions can be executed simultaneously. Any instructions attempted in excess of the limit are ignored.
Create a sequence program carefully so that the number of simultaneously executed MBRW instructions does not exceed 8.
- (4) The QJ71MT91 automatically opens a TCP connection with a target slave when this instruction is executed.
- (5) Whether TCP connection closing processing is performed or not can be selected in "Execution type ((S1)+0)" of the control data.
When communication with the same target device is made frequently using the dedicated instruction, setting "TCP connection is not closed after instruction completion" saves the time required for TCP connection opening for the subsequent instruction execution.
- (6) Whether the MBRW instruction is being executed or not and whether it is completed normally or not can be confirmed in the MODBUS[®] exception code ((S1)+2), and the completion device (D2) and completion status indication flag ((D2)+1) specified in the set data.
 - (a) MODBUS[®] exception code
Stores the exception code when the processing in the slave is completed with an error.
 - (b) Completion device (D2)
Turns ON in the END processing of the scan where the MBRW instruction is completed, and turns OFF in the next END processing.
 - (c) Completion status indication device ((D2)+1)
Turns ON/OFF depending on the status of the MBRW instruction completion.
Normal completion: Remains OFF.
Error completion : Turns ON in the END processing of the scan where the MBRW instruction is completed, and turns OFF in the next END processing.

[Operation for MBRW instruction execution]

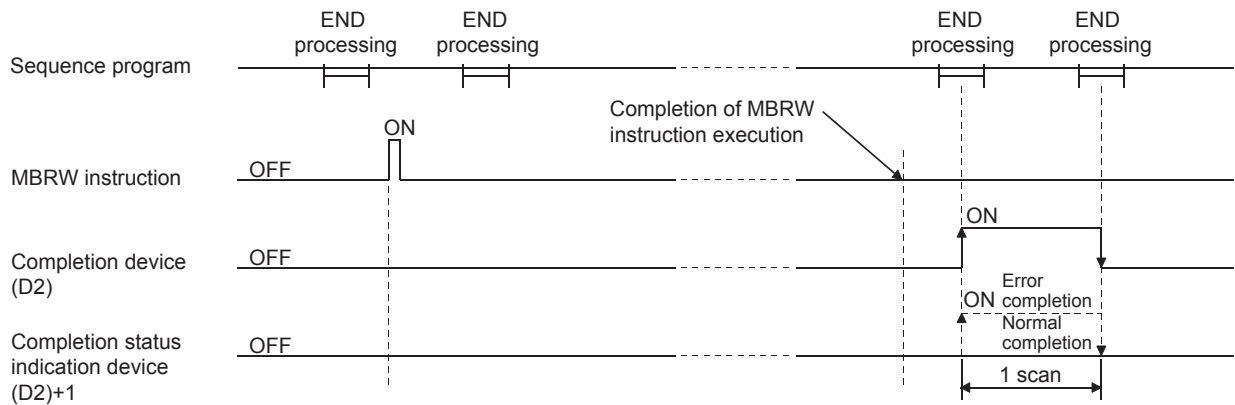

Error

- (1) When the dedicated instruction is completed with an error, the completion status indication device (D2)+1 turns ON and the error code is stored into the complete condition (S1)+1.
 When the processing in the slave is completed with an error, the exception code is stored into (S1)+2.
 According to the error code and exception code, check the error and take corrective action, referring to the following manual.
 <Error code>
 03E8H to 4FFFH : QCPU User's Manual (Hardware Design, Maintenance and Inspection)
 7300H or more : Section 11.3.3 in this manual
 <Exception code>
 Section 11.3.2 in this manual
- (2) If Basic parameter setting request (Y1) turns ON during execution of the MBRW instruction, the dedicated instruction is completed with an error.

Program example

The following program is designed to read and write the device data in the holding register of the slave (IP address: 192.1.0.2).

When the I/O signals of the QJ71MT91 are X/Y00 to X/Y1F

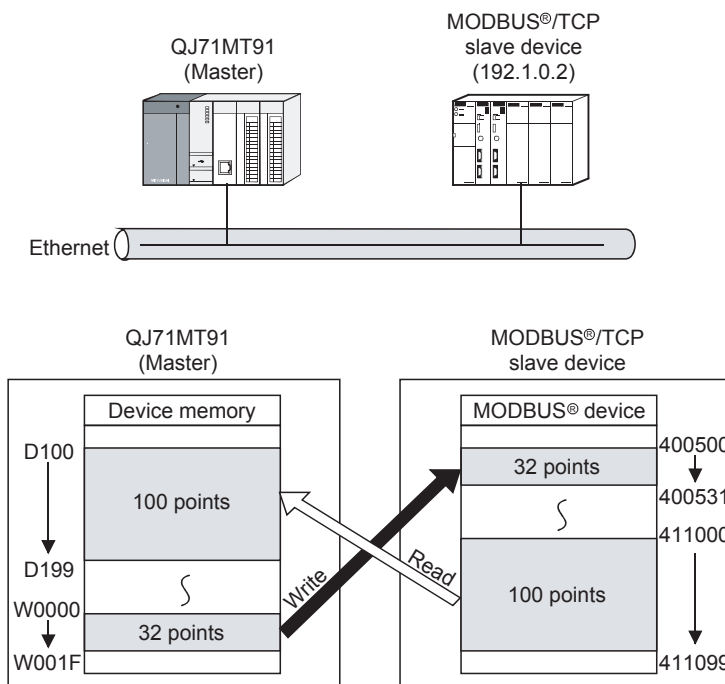

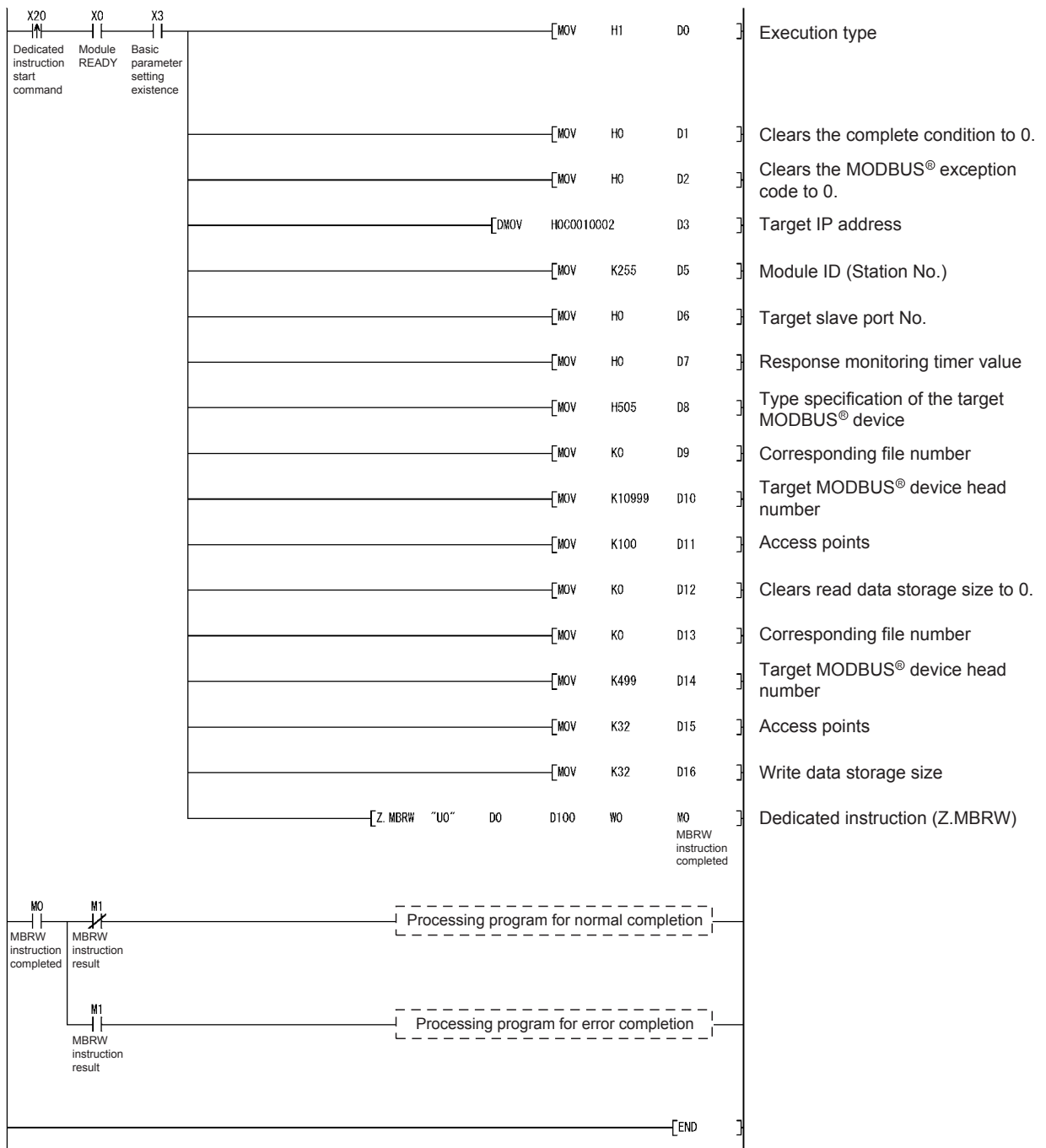

REMARK

The MODBUS® /TCP frames used in communication with the slave in this sample program are as shown below.

Request message format (Master (QJ71MT91) → Slave)

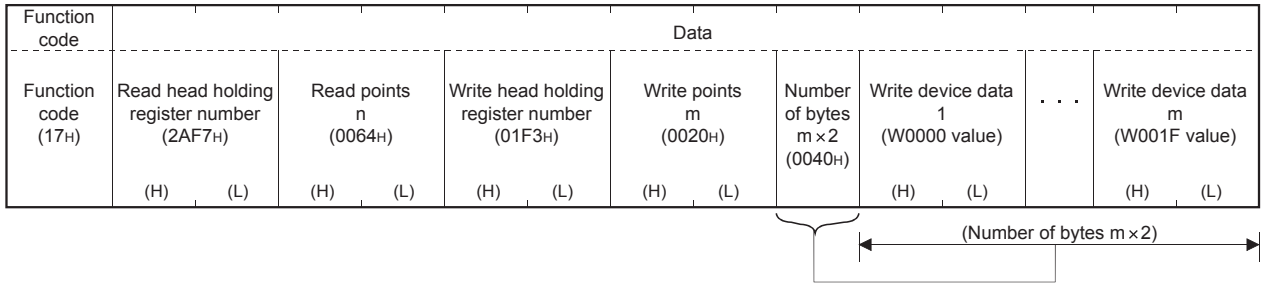

Response message format (Slave → Master (QJ71MT91))

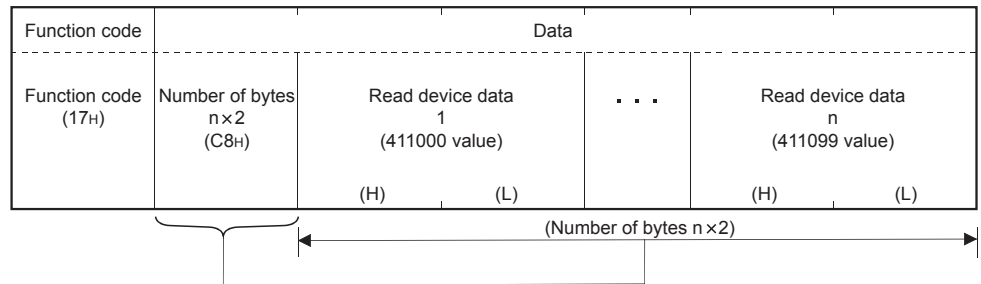

10.3 Z(P).MBREQ

With this instruction, a request message can be sent to the slave in any given PDU (protocol data unit) format.

Set Data	Usable Devices									
	Internal device (System, user)		File register	Link direct device J □ \ □		Intelligent function module device U □ \ G □	Index register Zn	Constant		Others
	Bit	Word		Bit	Word			K, H	\$	
(S1)	—	○								
(S2)	—	○								
(D1)	—	○								
(D2)		○								

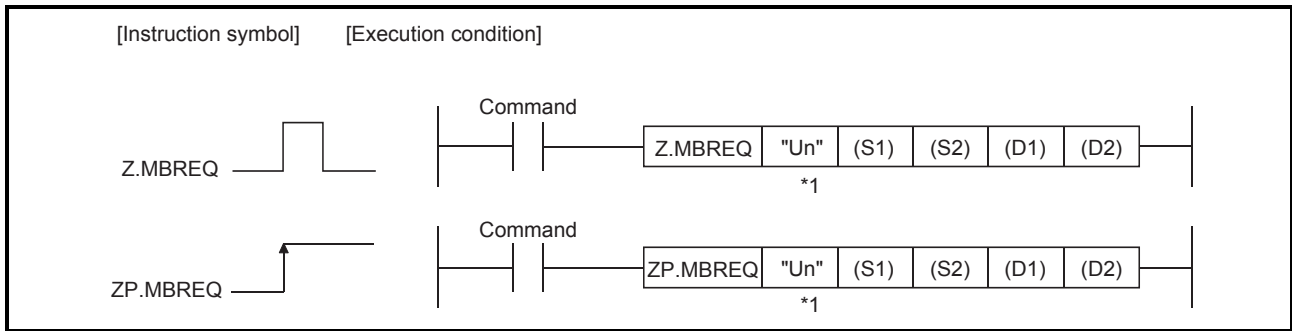

*1: If the originating station is a Basic model QCPU (function version B or later), or Universal model QCPU, "" (double quotation) of the first argument can be omitted.

Set data

Set data	Setting	Setting Side *2	Data Type
"Un"	Head I/O number of module (00H to FEH: upper 2 digits of the I/O number in 3-digit notation)	User	BIN 16 bits
(S1)	Head number of device where control data are stored	User, system	
(S2)	Request message storing head device	User	
(D1)	Response message storing head device	System	
(D2)	Device turned ON one scan on completion of the instruction (D2)+1 also turns ON for error completion.	System	Bit

*2: The setting side is as described below.

- User: Data are set by the user before dedicated instruction execution.
- System: The programmable controller CPU stores the result of dedicated instruction execution.

The local device and program-based file register are not available as the devices used for set data.

REMARK

Refer to Section 4.2 for details of the PDU (protocol data unit).

Control data

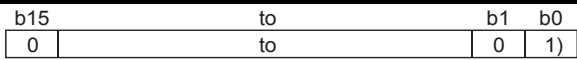
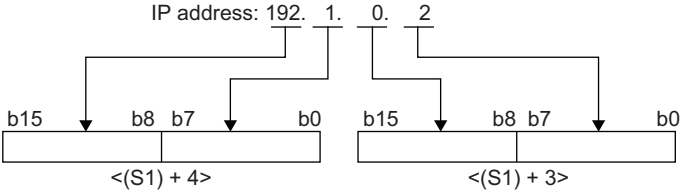
Device	Item	Set Data	Setting Range	Setting Side ²⁾
(S1)+0	Execution type	 <p>1) Close option (Bit 0) Set whether a TCP connection will be closed or not after instruction completion. 0: TCP connection is not closed after instruction completion. 1: TCP connection is closed after instruction completion.</p>	0, 1	User
(S1)+1	Complete condition	A condition when instruction is completed is stored. 0: Normal completion Other than 0: Error completion (error code) Refer to Section 11.3.3 for details of the error code.	—	System
(S1)+2	—	(Fixed value)	0	User
(S1)+3	Target IP address	Set the IP address of the target slave. IP address: 192. 1. 0. 2	Refer to *1	User
(S1)+4				
(S1)+5	Module ID	Set when a request message is sent to the slave without the MODBUS [®] /TCP interface via the MODBUS [®] serial gateway, etc. When the destination of the request message is the MODBUS [®] serial gateway, the set values are as described below. 0: Broadcast 1 to 247: Station number of MODBUS [®] serial slave *: Set "255" when the destination of the request message is the slave having the MODBUS [®] /TCP interface.	0 to 255	User
(S1)+6	Target slave port No.	Specify the port No. of the target slave. 0: Sent to No. 502 1 to 65535: Sent to the set port No.	0 1 to 65535 (*3)	User
(S1)+7	Response monitoring timer value	Specify the time for monitoring a response from the target device (slave). (500ms increments) 0: 60 (30s) 2 to 2400: Set value (Response monitoring timer value = Set value × 500ms)	0 2 to 2400	User

*1: Set the value that satisfies the following conditions.

Condition 1: The IP address class is any of A, B and C.

Condition 2: The host address bits are not all "0" or all "1".

*2: The setting side is as described below.

User: Data are set by the user before dedicated instruction execution.

System: The programmable controller CPU stores the result of dedicated instruction execution.

*3: When specifying a value of 32768 (8000H) or more in a sequence program, set the value in hexadecimal.

POINT

When the close option setting of the execution type ((S1)+0) is "TCP connection is closed after instruction completion", TCP connection is closed after the dedicated instruction has been completed and the completion device (D2) has turned ON. If the dedicated instruction is executed again for the same target device during this TCP connection closing processing, it is completed with an error. When the execution interval of the dedicated instruction for the same target device is short, set the close option to "TCP connection is not closed after instruction completion".

Request message storing devices

Device	Item	Set Data	Setting Range	Setting Side ^{*1}																																																																									
(S2)+0	Request message size [byte]	Set the size of the request message to be sent in byte units.	1 to 253	User																																																																									
(S2)+1 to (S2)+n	Request message	<p>Set the contents (function code + data) of the request message to be sent. (Example) When a request message to read the data of holding registers 440001 to 440002 is sent by Read holding registers (FC: 03)</p> <p><Frame of request message to be sent></p> <table border="1" style="margin-left: 20px;"> <tr> <td style="border: none;">Function code</td> <td colspan="4" style="border: none;">Data</td> </tr> <tr> <td style="border: none;">Function code</td> <td style="border: none;">Head holding register number</td> <td colspan="2" style="border: none;">Read points</td> <td style="border: none;"></td> </tr> <tr> <td style="border: none;">03H</td> <td style="border: none;">9CH</td> <td style="border: none;">40H</td> <td style="border: none;">00H</td> <td style="border: none;">03H</td> </tr> <tr> <td colspan="2" style="border: none;"></td> <td style="border: none; text-align: center;">Sending order</td> <td colspan="2" style="border: none;"></td> </tr> <tr> <td colspan="2" style="border: none;"></td> <td style="border: none; text-align: center;">(H)</td> <td style="border: none; text-align: center;">(L)</td> <td style="border: none; text-align: center;">(H) (L)</td> </tr> <tr> <td colspan="5" style="border: none; text-align: center;">5 bytes</td> </tr> </table> <p><Contents stored in request message storing devices and their order></p> <table border="1" style="margin-left: 20px;"> <tr> <td style="border: none;"><(S2) + 0></td> <td style="border: none;">b15</td> <td style="border: none;">b8</td> <td style="border: none;">b7</td> <td style="border: none;">b0</td> <td rowspan="4" style="border: none; vertical-align: middle;">Request message (= 5 bytes)</td> </tr> <tr> <td style="border: none;"></td> <td style="border: none;">00H</td> <td style="border: none;">05H</td> <td colspan="2" style="border: none;"></td> </tr> <tr> <td style="border: none;"><(S2) + 1></td> <td style="border: none;">b15</td> <td style="border: none;">b8</td> <td style="border: none;">b7</td> <td style="border: none;">b0</td> </tr> <tr> <td style="border: none;"></td> <td style="border: none;">9CH</td> <td style="border: none;">03H</td> <td colspan="2" style="border: none;"></td> </tr> <tr> <td style="border: none;"><(S2) + 2></td> <td style="border: none;">b15</td> <td style="border: none;">b8</td> <td style="border: none;">b7</td> <td style="border: none;">b0</td> <td rowspan="2" style="border: none; vertical-align: middle;">Request message</td> </tr> <tr> <td style="border: none;"></td> <td style="border: none;">00H</td> <td style="border: none;">40H</td> <td colspan="2" style="border: none;"></td> </tr> <tr> <td style="border: none;"><(S2) + 3></td> <td style="border: none;">b15</td> <td style="border: none;">b8</td> <td style="border: none;">b7</td> <td style="border: none;">b0</td> <td></td> </tr> <tr> <td style="border: none;"></td> <td style="border: none;">00H (Ignored)</td> <td style="border: none;">02H</td> <td colspan="2" style="border: none;"></td> </tr> </table> <p style="margin-left: 20px; text-align: center;">Send data storage order</p> <p style="margin-left: 20px;">(Request message is sent in order of low-order to high-order bytes, starting at the lowest device number.)</p>	Function code	Data				Function code	Head holding register number	Read points			03H	9CH	40H	00H	03H			Sending order					(H)	(L)	(H) (L)	5 bytes					<(S2) + 0>	b15	b8	b7	b0	Request message (= 5 bytes)		00H	05H			<(S2) + 1>	b15	b8	b7	b0		9CH	03H			<(S2) + 2>	b15	b8	b7	b0	Request message		00H	40H			<(S2) + 3>	b15	b8	b7	b0			00H (Ignored)	02H			As described on the left	User
Function code	Data																																																																												
Function code	Head holding register number	Read points																																																																											
03H	9CH	40H	00H	03H																																																																									
		Sending order																																																																											
		(H)	(L)	(H) (L)																																																																									
5 bytes																																																																													
<(S2) + 0>	b15	b8	b7	b0	Request message (= 5 bytes)																																																																								
	00H	05H																																																																											
<(S2) + 1>	b15	b8	b7	b0																																																																									
	9CH	03H																																																																											
<(S2) + 2>	b15	b8	b7	b0	Request message																																																																								
	00H	40H																																																																											
<(S2) + 3>	b15	b8	b7	b0																																																																									
	00H (Ignored)	02H																																																																											

*1: The setting side is as described below.
 User: Data are set by the user before dedicated instruction execution.
 System: The programmable controller CPU stores the result of dedicated instruction execution.

POINT
<p>(1) The request message data stored in the request message storing devices "(S2)+1 to (S2)+n" are sent in order of L (low-order) to H (high-order) bytes, starting at the lowest device number.</p> <p>(2) When the request message size is an odd number, the last high byte of the request message storing device is ignored. (The data are not sent.)</p>

Response message storing devices

Device	Item	Set Data	Setting Range	Setting Side ^{*1}																																																									
(D1)+0	Response message size [byte]	Set the size of the received response message in byte units.	0 to 253	System																																																									
(D1)+1 to (D1)+n	Response message	<p>Set the contents (function code + data) of the received response message. (Example) When the response message with Read holding registers (FC: 03) is received</p> <p><Received response message frame></p> <table border="1" style="width: 100%; border-collapse: collapse;"> <tr> <td colspan="2">Function code</td> <td colspan="4">Data</td> </tr> <tr> <td>Function code</td> <td>Number of read bytes</td> <td colspan="2">Device data 1</td> <td colspan="2">Device data 2</td> </tr> <tr> <td>03H</td> <td>04H *2</td> <td>00H</td> <td>05H</td> <td>12H</td> <td>34H</td> </tr> <tr> <td colspan="2"></td> <td colspan="4" style="text-align: center;"> <div style="border: 1px solid black; border-radius: 5px; padding: 2px; display: inline-block;">Receiving order</div> </td> </tr> <tr> <td colspan="2"></td> <td style="text-align: center;">(H)</td> <td style="text-align: center;">(L)</td> <td style="text-align: center;">(H)</td> <td style="text-align: center;">(L)</td> </tr> </table> <p style="text-align: center;">←----- 6 bytes -----→</p> <p><Contents stored in response message storing devices and their order></p> <table border="1" style="width: 100%; border-collapse: collapse;"> <tr> <td style="width: 15%;"></td> <td style="width: 15%;">b15</td> <td style="width: 15%;">b8</td> <td style="width: 15%;">b7</td> <td style="width: 15%;">b0</td> <td rowspan="4" style="width: 20%; vertical-align: middle;"> Response message size (= 6 bytes) } Response message </td> </tr> <tr> <td><(D1) + 0></td> <td>00H</td> <td>06H</td> <td></td> <td></td> </tr> <tr> <td><(D1) + 1></td> <td>04H</td> <td>03H</td> <td></td> <td></td> </tr> <tr> <td><(D1) + 2></td> <td>05H</td> <td>00H</td> <td></td> <td></td> </tr> <tr> <td><(D1) + 3></td> <td>34H</td> <td>12H</td> <td></td> <td></td> <td></td> </tr> </table> <p style="text-align: center;"> <div style="border: 1px solid black; border-radius: 5px; padding: 2px; display: inline-block;">Received data storage order</div> </p> <p style="text-align: center;">←-----</p> <p>(Response message is stored in order of low-order to high-order bytes, starting at the lowest device number.)</p>	Function code		Data				Function code	Number of read bytes	Device data 1		Device data 2		03H	04H *2	00H	05H	12H	34H			<div style="border: 1px solid black; border-radius: 5px; padding: 2px; display: inline-block;">Receiving order</div>						(H)	(L)	(H)	(L)		b15	b8	b7	b0	Response message size (= 6 bytes) } Response message	<(D1) + 0>	00H	06H			<(D1) + 1>	04H	03H			<(D1) + 2>	05H	00H			<(D1) + 3>	34H	12H				As described on the left	System
Function code		Data																																																											
Function code	Number of read bytes	Device data 1		Device data 2																																																									
03H	04H *2	00H	05H	12H	34H																																																								
		<div style="border: 1px solid black; border-radius: 5px; padding: 2px; display: inline-block;">Receiving order</div>																																																											
		(H)	(L)	(H)	(L)																																																								
	b15	b8	b7	b0	Response message size (= 6 bytes) } Response message																																																								
<(D1) + 0>	00H	06H																																																											
<(D1) + 1>	04H	03H																																																											
<(D1) + 2>	05H	00H																																																											
<(D1) + 3>	34H	12H																																																											

- *1: The setting side is as described below.
 User: Data are set by the user before dedicated instruction execution.
 System: The programmable controller CPU stores the result of dedicated instruction execution.
- *2: The number of read bytes is 4 from "2 (Read points) × 2 = 4".

POINT

(1) The received response message data are stored in order of L (low-order) to H (high-order) bytes, starting at the lowest device number of the response message storing devices "(D1)+1 to (D1)+n".

(2) When the response message size is an odd number, the last high byte of the response message storing device is overwritten by 0.

Function

- (1) To the slave specified by the Target IP address of the control data, the request message can be sent using any given PDU (protocol data unit) format.
- (2) A maximum of eight MBREQ instructions can be executed simultaneously. Any instructions attempted in excess of the limit are ignored. Create a sequence program so that the number of simultaneously executed MBREQ instructions does not exceed 8.
- (3) The QJ71MT91 automatically opens a TCP connection with a target slave when this instruction is executed.
- (4) Whether TCP connection closing processing is performed or not can be selected in "Execution type ((S1)+0)" of the control data. When communication with the same target device is made frequently using the dedicated instruction, setting "TCP connection is not closed after instruction completion" saves the time required for TCP connection opening for the subsequent instruction execution.
- (5) Whether the MBREQ instruction is being executed or not and whether it is completed normally or not can be confirmed in the completion device (D2) and completion status indication device ((D2)+1) specified in the set data.
 - (a) Completion device (D2)
Turns ON in the END processing of the scan where the MBREQ instruction is completed, and turns OFF in the next END processing.
 - (b) Completion status indication device ((D2)+1)
Turns ON/OFF depending on the status of the MBREQ instruction completion.
Normal completion: Remains OFF.
Error completion : Turns ON in the END processing of the scan where the MBREQ instruction is completed, and turns OFF in the next END processing.

[Operation for MBREQ instruction execution]

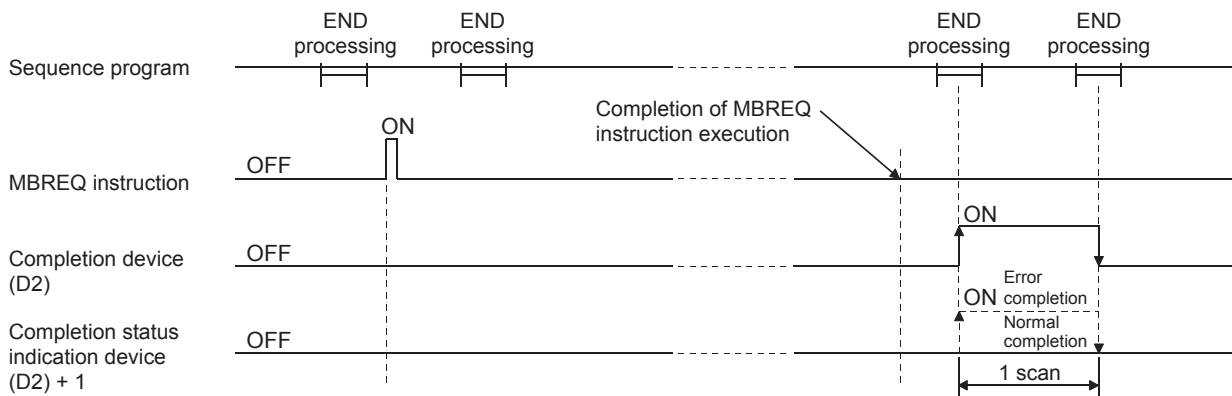

Error

- (1) When the dedicated instruction is completed with an error, the completion status indication device (D2)+1 turns ON and the error code is stored into the complete condition (S1)+1.
According to the error code, check the error and take corrective action, referring to the following manual.
<Error code>
03E8H to 4FFFH : QCPU User's Manual (Hardware Design, Maintenance and Inspection)
7300H or more : Section 11.3.3 in this manual
- (2) If Basic parameter setting request (Y1) turns ON during execution of the MBREQ instruction, the dedicated instruction is completed with an error.

POINT
<p>(1) In the case of the MBREQ instruction, exception codes and function codes are not stored in the Error log (address: 0CFEH to 0DFFH) of the buffer memory. Check the exception and function codes by the response message that is stored in the response message storage device.</p> <p>(2) This instruction is completed normally even if the target slave device gives an exception response. When the instruction is completed normally, check the highest-order bit of the function code in the response message to determine whether the response is normal or not. (For an exception response, the highest-order bit in the first byte of the receive data turns ON.) For an exception response, check the exception code (the second byte of the receive data) in the response message and take corrective action. (Refer to Section 11.3.2.)</p>

Program example

The following program is designed to send the request message to write the value OR-masked with 0008H to the holding register 400003 (Mask write register (FC: 22) of the slave (IP address: 192.1.0.2).

When the I/O signals of the QJ71MT91 are X/Y00 to X/Y1F

(1) Operation of program example

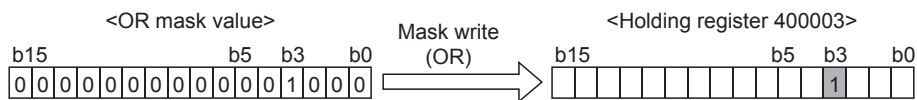
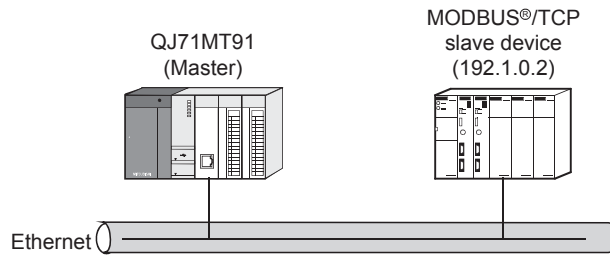

(2) Frames sent and received by MBREQ instruction

(a) Request message format (Master (QJ71MT91) → Slave)

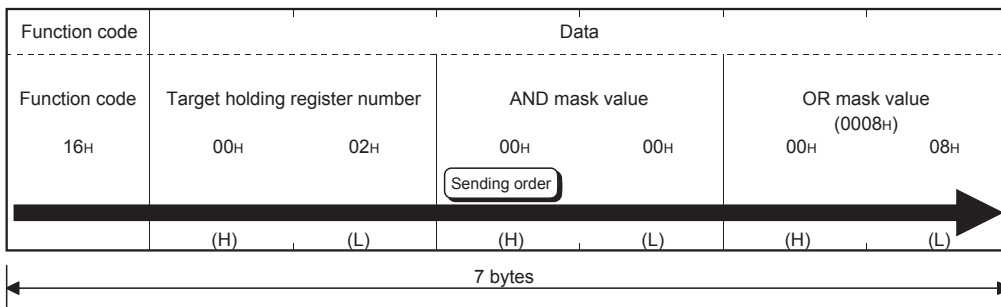

(b) Response message format
<When completed normally>

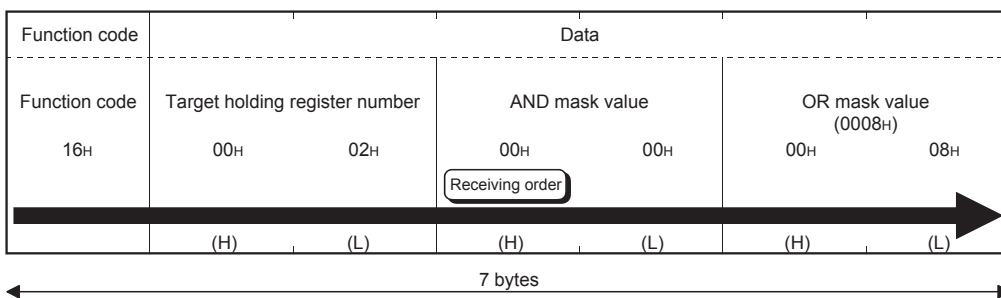

<When completed with an error>

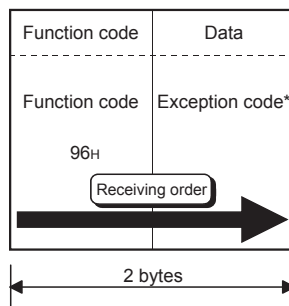

*: Refer to Section 11.3.2 for details of the exception code.

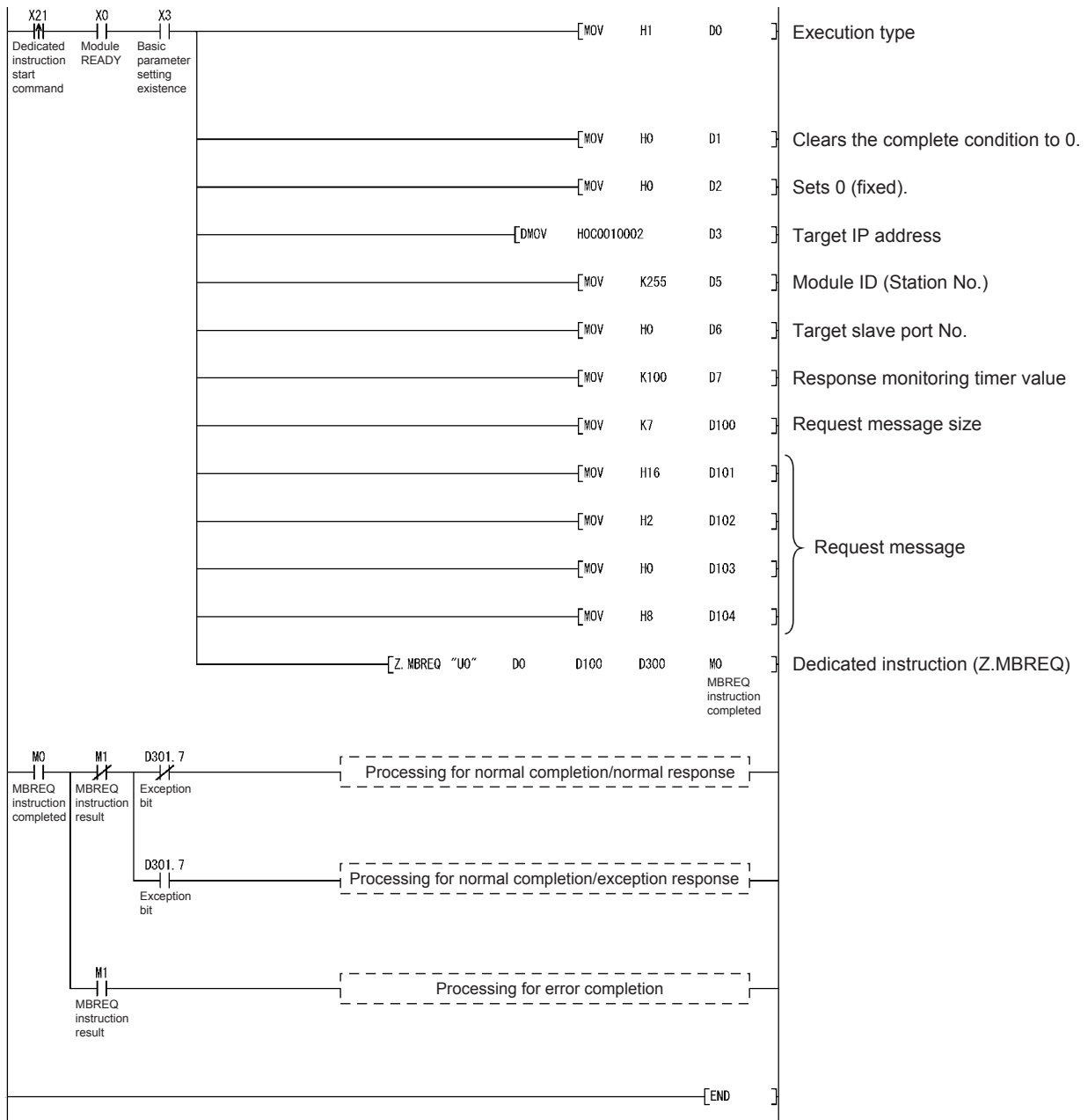

11 TROUBLESHOOTING

11

This chapter explains the error details and corrective actions.

11.1 Troubleshooting

(1) Troubleshooting of errors indicated by LEDs

No.	Symptom	Check Item	Corrective Action	Reference Section
1	RUN LED turned off.	Check the mounting status of the QJ71MT91.	Switch the power off and remount the QJ71MT91.	Section 6.1
		Check the power supply capacity.	Change the power supply module.	Section 3.1
		Check the programmable controller CPU.	If the programmable controller CPU is faulty, take corrective action according to the QCPU User's Manual (Hardware Design, Maintenance and Inspection).	—
		Check for a watch dog timer error (X1F).	<ul style="list-style-type: none"> Reset the programmable controller CPU or power the programmable controller off and then on. If the problem still persists after resetting it again, the possible cause is a hardware fault. Perform a hardware test, and replace the QJ71MT91. 	—
2	ERR. LED turned on.	Check the intelligent function module switch 1 (operation mode setting) value.	Check the setting range of each intelligent function module switch, and correct the value.	Section 6.6
		Check the intelligent function module switch 2 (communication condition setting) value.		
		Check the intelligent function module switch 3, 4 (IP address setting) value.		
		Check if the QJ71MT91 is not mounted with the A mode QCPU.	Mount the QJ71MT91 with the Q mode QCPU.	Section 2.1
		Check if the module is in the hardware or self-loopback test mode.	<ul style="list-style-type: none"> Restart the test after checking the mounting status of the QJ71MT91. If the ERR. LED turns on again, the possible cause is a hardware fault. Change the QJ71MT91. 	Section 6.5.1 Section 6.5.2
		Refer to "RUN LED turned off."		This section (1)-1
3	COM. ERR. LED turned on.	Check if the basic parameter setting, error completed (X2) is on.	Refer to "Basic parameter setting, error completed (X2) turned on."	This section (2)-3
		Check if the automatic communication parameter setting, error completed (X5) is on.	Refer to "Automatic communication parameter setting, error completed (X5) turned on."	This section (2)-5

No.	Symptom	Check Item	Corrective Action	Reference Section
3	COM. ERR. LED turned on.	Check if the MODBUS® device assignment parameter setting, error completed (X9) is on.	Refer to "MODBUS® device assignment parameter setting, error completed (X9) turned on."	This section (2)-6
		Check if the automatic communication error status (X7) is on.	Refer to the automatic communication operation status storage area [0C20H to 0C23H], identify the parameter number where the error occurred, confirm the error code stored in the corresponding automatic communication error code storage area [0C28H to 0C67H] or the exception code from the target slave, and take corrective action. Turn off the COM. ERR. LED.	Section 11.3.1
		When the dedicated instruction is used, check it for an error.	Refer to "Dedicated instruction failed." Turn off the COM. ERR. LED.	This section (3)-2
		Check the error code in the error log.	Take the corresponding corrective action. Turn off the COM. ERR. LED.	Section 11.3
		Refer to "Communication with target device cannot be made even though each parameter setting is completed."		This section (3)-6
4	INIT. LED does not turn on.	Check the basic parameter setting.	Set the basic parameters from GX Configurator-MB or from the sequence program. In the setting of intelligent function module switch 2 (communication condition setting) - b0: Basic parameter starting method, select "OFF: Start with the default parameters".	Chapter 7 Chapter 8 Section 9.1.1
		Check if the basic parameter setting, error completed (X2) is on.	Refer to "Basic parameter setting, error completed (X2) turned on."	This section (2)-3
		When using the automatic communication function	Refer to "Automatic communication parameter setting, error completed (X5) turned on." or "Automatic communication operation status (X6) does not turn on."	This section (2)-5, (2)-7
5	The SD LED does not flicker during data transmission. The RD LED does not flicker during data reception.	When using dedicated instruction	Refer to "Dedicated instruction is not executed."	This section (3)-1
		When using slave function	Refer to "Slave function of QJ71MT91 does not return response message to request message."	This section (3)-3
		When using GX Developer connection	Refer to "GX Developer cannot be connected."	This section (3)-4

(2) Troubleshooting of errors indicated by X signals

No.	Symptom	Check Item	Corrective Action	Reference Section
1	Module READY (X0) turned off.	Refer to "RUN LED turned off."		This section (1)-1
2	Watch dog timer error (X1F) turned on.			
3	Basic parameter setting, error completed (X2) turned on.	Refer to the basic parameter error code storage area (0C10H) and confirm the error code.	Take the corresponding corrective action and retry.	Section 7.2 Section 11.3
4	Basic parameter setting existence (X3) does not turn on.	Check if basic parameter setting has been completed.	Set the basic parameters from GX Configurator-MB or from the sequence program. In the setting of intelligent function module switch 2 (communication condition setting) - b0: Basic parameter starting method, select "OFF: Start with the default parameters".	Section 7.2 Section 9.1.1 Section 6.6
		Refer to the basic parameter error code storage area (0C10H) and confirm the error code.	Take the corresponding corrective action and retry.	Section 7.4 Section 11.3
5	Automatic communication parameter setting, error completed (X5) turned on.	Refer to the automatic communication parameter error code storage area (0C11H) and confirm the error code, and refer to the automatic communication parameter setting result storage area (0C12H) and identify the parameter number where the error occurred.	Take the corresponding corrective action and retry.	Section 7.3 Section 11.3
6	MODBUS [®] device assignment parameter setting, error completed (X9) turned on.	Confirm the error code in the MODBUS [®] device assignment parameter error code storage area.	Take the corresponding corrective action and retry.	Section 7.4 Section 11.3
7	Automatic communication operation status (X6) does not turn on.	Check if the automatic communication function is active.	Set the automatic communication parameters and activate it from GX Configurator-MB or from the sequence program.	Section 7.3 Section 9.1.2
		Check if the automatic communication parameter setting, error completed (X5) is on.	Refer to "Automatic communication parameter setting, error completed (X5) turned on."	This section (2)-5
		Check if the INIT. LED is on.	Refer to "INIT. LED does not turn on."	This section (1)-4
		Check if the basic parameter setting, error completed (X2) is on.	Refer to "Basic parameter setting, error completed (X2) turned on."	This section (2)-3

No.	Symptom	Check Item	Corrective Action	Reference Section
8	Automatic communication operation status (X6) turned off.	Check the automatic communication stop request.	Restart the automatic communication function.	Section 7.3 Section 5.2.1
		Check whether the basic parameters were re-set while the automatic communication function was active. (The automatic communication is stopped when the basic parameters are re-set.)	Restart the automatic communication function after completing basic parameter re-setting.	Section 7.2 Section 7.3 Section 5.2.1
9	Automatic communication error status (X7) turned on.	Check if the communication with the target device is possible.	Check the Automatic communication operation status storage area (0C20H to 0C23H) in the buffer memory and identify the parameter number of the error cause. Take corrective actions according to the error code currently stored in the Automatic communication error code storage area (0C28H to 0C67H) or the exception code sent from the target slave.	Section 11.3.1
10	COM. ERR. LED status (X1B) turned on.	Refer to "COM. ERR. LED turned on."		This section (1)-3
11	MODBUS [®] device assignment parameter setting existence (XA) does not turn on.	Check whether the slave function is used or not?	When the slave function is not used, the MODBUS [®] device assignment parameter setting existence (XA) may be off.	—
		Check if the MODBUS [®] device assignment parameter setting has been completed.	Set the MODBUS [®] device assignment parameters from GX Configurator-MB or from the sequence program.	Section 7.4 Section 9.1.3
			In the setting of intelligent function module switch 2 (communication condition setting) - b1: MODBUS [®] device assignment parameter starting method, select "OFF: Start with the default parameters".	Section 6.6
Check if the MODBUS [®] device assignment parameter setting, error completed (X9) is on.	Refer to "MODBUS [®] device assignment parameter setting, error completed (X9) turned on."	This section (2)-6		

(3) Troubleshooting for system switching in a redundant system

No.	Symptom	Check Item	Corrective Action	Reference Section
1	The systems are not switched when communication error occurs.	Is the QJ71MT91 mounted the function version D?	Replace the QJ71MT91 with the one having the function version D or later	—
		Has the QJ71MT91 issued a system switching request to the control system CPU module?	Use SD1590 of the control system CPU module to check if the QJ71MT91 has issued a system switching request.	—
		Is the system switching setting enabled?	Check if the system switching cause settings (b1 to b3) in the intelligent function module switch 5 (redundant settings) are enabled.	Section 6.6
		Is any Ethernet cable disconnected when linkup has not yet been performed after system startup?	Check the wiring status of the Ethernet cable. (The system switching due to the disconnection detection can be detected after linkup was performed normally.)	—
		Is the setting value of the disconnection detection time correct?	Review the setting value of the disconnection detection time (b8 to b15) in the intelligent function module switch 5 (redundant settings).	Section 6.6
		Is the setting value in TCP ULP timer correct?	Review the TCP ULP timer value of the basic parameter.	Section 7.2
		Is the KeepAlive enabled?	Set the KeepAlive of the basic parameter to "Used" to switch the systems by timeout detection of KeepAlive.	Section 5.4 Section 7.2
		Is the setting value in the KeepAlive start timer correct?	Review the KeepAlive start timer value of the basic parameter.	Section 5.4 Section 7.2
		Is the setting value in the KeepAlive interval timer correct?	Review the KeepAlive interval timer value of the basic parameter.	Section 5.4 Section 7.2
Is the TCP connection open?	Review the wiring and communication setting and open the TCP connection. (The system switching due to the communication error can be detected after the TCP connection was opened normally.)	—		

No.	Symptom	Check Item	Corrective Action	Reference Section
1	The systems are not switched when communication error occurs.	Is the standby system CPU module operating normally?	<ul style="list-style-type: none"> • Check if the power supply module of the standby system is powered on. • Check if the RESET/L.CLR switch of the standby system CPU module is set to the central position (reset clear). • Check if no error is occurring in the standby system CPU module. 	—
		Is the tracking cable connected properly?	Connect the tracking cable properly.	—
		Has the QJ71MT91 issued a system switching request to the standby system CPU module?	Issue a system switching request to the control system CPU module.	—
		Is there any cause, such as a standby system CPU module stop error, which disables system switching even when the QJ71MT91 issues a system switching request?	Remove the cause of the system switching failure in the standby system CPU module.	—
		Are the parameter and program written in the Redundant CPU in the backup mode?	Change the parameter and program to the backup mode and write them to the Redundant CPU.	—
2	The systems are consecutively switched.	Is the value of the timeout occurrence time too small?	Increase a timeout occurrence time to an acceptable value as a system.	—
3	When using the redundant IP mode, the MODBUS [®] /TCP master cannot communicate with the QJ71MT91 of the new control system after a system switching.	Is the QJ71MT91 used as the MODBUS [®] /TCP master?	Use the fixed IP mode when using the QJ71MT91 as the MODBUS [®] /TCP master. (The redundant IP mode cannot be used.)	—
		Is the Gratuitous ARP disabled in a security software setting (ARP spoofing measures) on the MODBUS [®] /TCP master side?	<ul style="list-style-type: none"> • Check if the MODBUS[®] /TCP master device supports the Gratuitous ARP. • Review the security software settings on the MODBUS[®] /TCP master side. • Use the fixed IP mode. 	—

(4) Troubleshooting for other symptoms

No.	Symptom	Check Item	Corrective Action	Reference Section
1	Dedicated instruction is not executed. (Complete device (D2) does not turn on.)	Check if the dedicated instruction is active.	Start the dedicated instruction.	—
		Check whether the programmable controller CPU is in the RUN status or not.	RUN the programmable controller CPU.	—
		While the dedicated instruction is executed, the related starting contact was turned on. (When a starting contact is turned on with the related dedicated instruction being executed, the start instruction is ignored.)	Retry after the dedicated instruction is completed.	—
		Check whether more than the executable dedicated instructions (8 instructions) were started.	Retry after the dedicated instructions being executed are completed.	Chapter 10
		Check whether the dedicated instruction failed or not.	Refer to "Dedicated instruction failed.".	This section (3)-2
		Check whether the module is waiting for a response from the target device with the dedicated instruction already being executed.	<ul style="list-style-type: none"> • Wait for the response monitoring timer to expire. • Check the target device status. • If an error occurs, refer to "Dedicated instruction failed.". 	Section 7.2 This section (3)-2
2	Dedicated instruction failed.	Check if the INIT. LED is on.	Refer to "INIT. LED does not turn on.".	This section (1)-4
		Confirm the error code or exception code stored in the control data of the dedicated instruction.	Take the corresponding corrective action and retry.	Chapter 10 Section 11.3
		Check whether the target device supports the corresponding function code.	<MBRW instruction> Change the device type of the control data so that the function code supported by the target device is issued.	Section 10.2
			<MBREQ instruction> Change the send data so that the function code supported by the target device is issued.	Section 10.3
		When the MBREQ dedicated instruction is used, check the created request message.	Correct the request message and retry.	Chapter 4 Section 10.3
		Refer to "Communication with target device cannot be made if each parameter setting is completed.".		This section (3)-6

No.	Symptom	Check Item	Corrective Action	Reference Section
3	Slave function of QJ71MT91 does not return response message to request message.	Check if the INIT. LED is on.	Refer to "INIT. LED does not turn on.".	This section (1)-4
		Check if the MODBUS [®] device assignment parameter setting existence (XA) is on.	Refer to "MODBUS [®] device assignment parameter setting existence (XA) does not turn on.".	This section (2)-11
		Check whether the basic parameters were re-set during reception of a request message. (The slave function stops when the basic parameters are re-set.)	Restart the automatic communication function after basic parameter re-setting is completed.	Section 7.2
		Check whether the QJ71MT91 has returned an exception code or not.	Confirm the exception code and take corrective action.	Section 11.3.2
		Refer to the error log area (0CFEH to 0DFFH) and confirm the error code.	Take the corresponding corrective action.	Section 11.3
		Is the request message sent to the QJ71MT91 correct? Check the following for the message length. • The application data unit length in Ethernet frame is 6 or more (From "Transaction ID" to "Message length" in MBAP header). • The MBAP header length + 6 equals the application data unit length in Ethernet frame.	Correct the request message issued by the master.	Chapter 4
4	GX Developer cannot be connected.	Check if the INIT. LED is on.	Refer to "INIT. LED does not turn on.".	This section (1)-4
		When using the TCP protocol, check whether the set number of TCP connections for GX Developer connection is 0 or not.	Set the necessary number of TCP connections for GX Developer connection (0030H), and re-set the basic parameter.	Section 7.2.3
		Check the GX Developer connection setup screen settings.	Correct the GX Developer connection setup screen settings if it has a problem.	—
		Refer to "Communication with target device cannot be made even though each parameter setting is completed.".		This section (3)-6
5	Error log has errors.	Refer to the error log area (0CFEH to 0DFFH) and confirm the error code.	Take the corresponding corrective action.	Section 11.3
		Refer to "Communication with target device cannot be made even though each parameter setting is completed.".		This section (3)-6

No.	Symptom	Check Item	Corrective Action	Reference Section
6	Communication with target device cannot be made even though each parameter setting is completed.	Check the local station IP address (intelligent function module switch 3, 4) setting.	If necessary, correct the setting and reset the CPU.	Section 6.6
		Check the intelligent function module switch 2 (communication condition setting) -b3: Send frame specification selection.	If necessary, correct the setting and reset the CPU.	Section 6.6
		Check the network cable connection.	Connect the network cable correctly.	Section 6.4
		Check the network cable specifications.	Confirm the specifications of the used network cable.	Section 3.1
		Check whether data has reached the target device.	<ul style="list-style-type: none"> Conduct a PING test to check the target device status and line status. If the data has not reached the target device, check the route and line status, and take corrective action if necessary. When data is sent via a router, check the routing information settings of the QJ71MT91 and target device. 	Section 7.2 Section 11.5
		Check the target device. <ul style="list-style-type: none"> Check for errors. Check whether the target device is ready for operation. Check whether the target device is attempting to communicate with the QJ71MT91. 	Take corrective action if the target device has any problem.	—
		Check the line status.	Correct the line status if it has any problem in traffic.	—
		Check for any TCP connection disconnected automatically by the KeepAlive function.	<ul style="list-style-type: none"> Check that the target device is operating normally. Adjust the KeepAlive start timer value and KeepAlive interval timer value. 	Section 5.4 Section 7.2
		When the QJ71MT91 is the master, check if the communication target device is a MODBUS [®] /TCP slave device.	Set a MODBUS [®] /TCP slave device as the communication target.	—
When the QJ71MT91 is a slave, check if the communication target device is a MODBUS [®] /TCP master device.	Set a MODBUS [®] /TCP master device as the communication target device.	—		
Check if the number of TCP connections connected simultaneously is within 64.	<ul style="list-style-type: none"> Retry as TCP connections may fail temporarily. TCP connections with the nodes not specified as preferred ones may be disconnected automatically when the connection resources become insufficient. Specify the nodes as preferred ones when necessary. Reduce the number of simultaneously connected connections. 	Section 3.1 Section 7.2		

No.	Symptom	Check Item	Corrective Action	Reference Section
6	Communication with target device cannot be made even though each parameter setting is completed.	Check if the total number of TCP connections specified for use with preferred nodes is within 64.	As the connection resources are all assigned to the preferred nodes, the other nodes cannot communicate. Delete the unnecessary preferred node specifications.	Section 7.2
7	Communication interval time with the slave by the automatic communication function is longer than time set to the repeat interval timer. Dedicated instruction requires a long time to be completed.	Check the target device. <ul style="list-style-type: none"> • Check for errors. • Check whether the target device is ready for operation. 	Take corrective action if the target device has any problem.	—
		Check the line status.	Correct the line status if it has any problem in traffic.	—
		Check for any TCP connection disconnected automatically by the KeepAlive function.	<ul style="list-style-type: none"> • Check that the target device is operating normally. • Adjust the KeepAlive start timer value and KeepAlive interval timer value. 	Section 5.4 Section 7.2
		Check if the number of TCP connections connected simultaneously is within 64.	<ul style="list-style-type: none"> • Retry as TCP connections may fail temporarily. • TCP connections with the nodes not specified as preferred ones may be closed automatically when the connection resources become insufficient. Specify the nodes as preferred ones when necessary. • Reduce the number of simultaneously connected connections. 	Section 3.1 Section 7.2
		Check whether the QJ71MT91 has issued two or more send requests concurrently.	If two or more send requests are issued, long time is required as they are processed in due order. Reduce the QJ71MT91 loads.	—
		Check whether the target device requires a long time to respond.	<ul style="list-style-type: none"> • Confirm the processing performance of the target device. • If the target device has any problem, check and take corrective action. 	—
8	QJ71MT91 responds slowly.	Check the specifications using the processing time performance expression of the QJ71MT91 slave function.	Reduce the processing time to within the range of the performance expression.	Appendix 2
		Check whether the QJ71MT91 has issued two or more send requests concurrently.	If two or more send requests are issued, long time is required as they are processed in due order. Reduce the QJ71MT91 loads.	—
		Check the line status.	Correct the line status if it has any problem in traffic.	—

No.	Symptom	Check Item	Corrective Action	Reference Section
8	QJ71MT91 responds slowly.	When accessing the programmable controller CPU device in the slave function, check if access to the programmable controller CPU from the other modules and sequence program is too often.	Reduce the programmable controller CPU loads.	—
		Check for any TCP connection disconnected automatically by the KeepAlive function.	<ul style="list-style-type: none"> • Check that the target device is operating normally. • Adjust the KeepAlive start timer value and KeepAlive interval timer value. 	Section 5.4 Section 7.2
		Check if the number of TCP connections connected simultaneously is within 64.	<ul style="list-style-type: none"> • TCP connections may fail temporarily. Retry the connection. • TCP connections with the nodes not specified as preferred ones may be closed automatically when the connection resources become insufficient. Reconnect and retry. Specify the nodes as preferred ones when necessary. 	Section 7.2
9	Normal communication is not available after replacement of QJ71MT91 or target device.	Check if the power was reapplied after replacement of the QJ71MT91 or target device.	Reapply the power of the QJ71MT91 or target device. (When the target device has the Ethernet address of the communication target, continued communication may be disabled since the Ethernet address changed due to the replacement of the QJ71MT91.)	—

11.2 Confirming QJ71MT91 Status

This section explains how to confirm the QJ71MT91 status.

Method	Reference Section
Monitor/Test screen of GX Configurator-MB	This section (1)
System monitor screen of GX Developer	This section (2)

(1) Monitoring/testing from GX Configurator-MB

GX Configurator-MB has a Monitor/Test screen for the status display and test of the QJ71MT91.

Refer to Section 8.6 for the Monitor/Test screen.

(2) System monitor of GX Developer

The module status of the QJ71MT91 can be confirmed from the system monitor.

- (a) When confirming the module status and error code on the Module's Detailed Information screen of the diagnostic function

[Starting Procedure]

GX Developer → [Diagnostics] → [System monitor] →
Module's Detailed Information

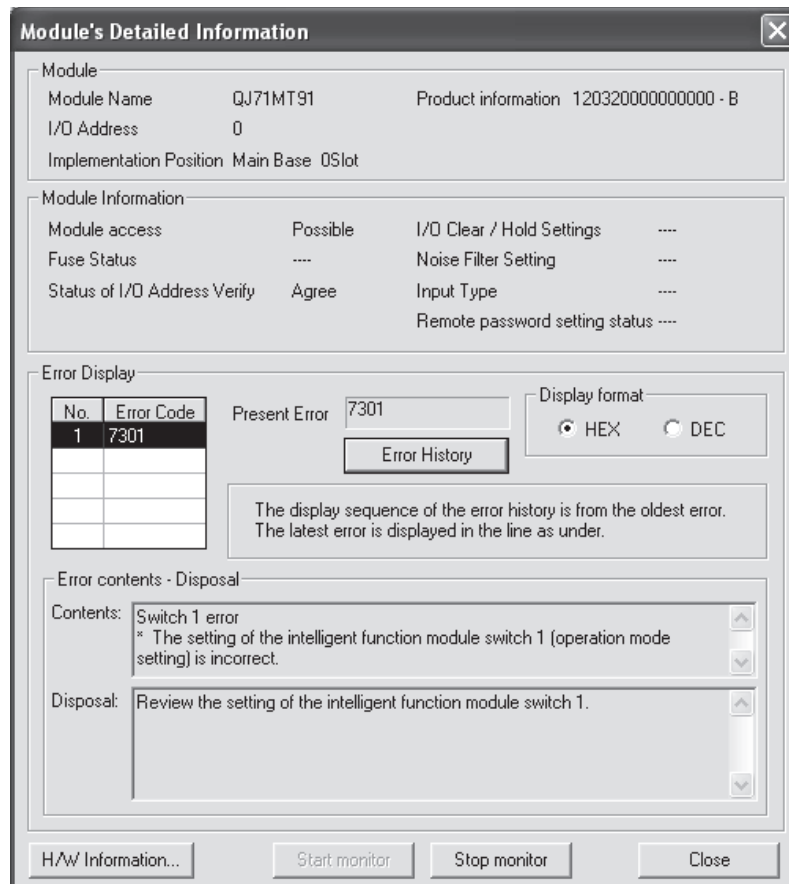

[Display Data]

▪ Module

The following data are displayed.

Module Name : Mounted module model name

I/O Address : Head I/O signal number of the target module

Implementation Position

: Slot position where the module is mounted

Product information : Product information

* The alphabet at the end of the production information indicates the function version of the module.

Function version of the QJ71MT91 is available from B.

(Example) The product information that ends with "B" indicates that the module is of function version B.

▪ Module access

Displays Enable when Module READY (X0) is on and Watch dog timer error (X1F) is off.

▪ Status of I/O Address Verify

Displays whether the module parameter-set by the user matches the actually mounted module or not.

▪ Error Display

Displays the 16 latest error codes stored in the error log area of the buffer memory.

▪ Present Error

Displays the error code of the latest error.

Refer to Section 11.3 for the error code.

▪ Error contents-Disposal

Displays the error contents and disposal for the error code selected in Error Display.

Display of the contents and disposal is available on GX Developer Version 8.29F or later.

(b) When confirming the LED status and switch setting status on the H/W Information screen of the diagnostics function

The H/W Information screen can be confirmed on GX Developer 8.29F or later.

[Starting Procedure]

GX Developer → [Diagnostics] → [System monitor] →
 [Module's Detailed Information] → [H/W Information]

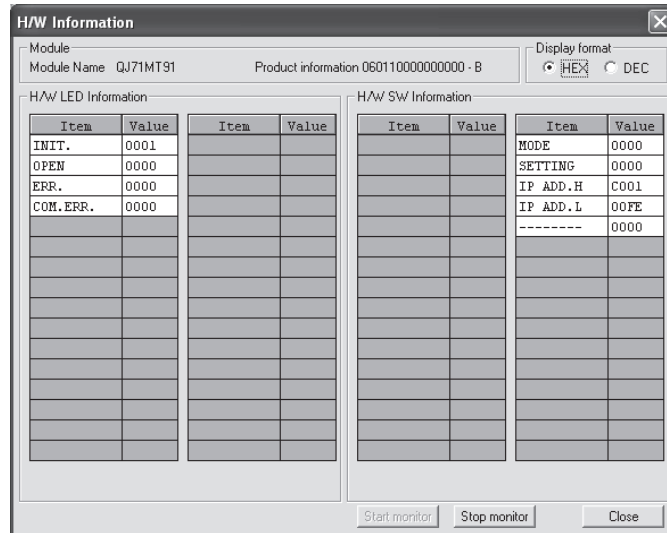

[Display Data]

The QJ71MT91 data stored in the following buffer memory areas are displayed.

Display Data		Corresponding Buffer Memory Area		Address
Left side of H/W LED Information (*1) (*2)		Module status: LED status (*1) (*2) (*3)		0C05H(3077)
Right side of H/W SW Information	MODE	Intelligent function module switch (*4)	Switch 1: Operation mode setting status	0C00H(3072)
	SETTING		Switch 2: Communication condition setting status	0C01H(3073)
	IP ADD.H		Switch 3: Local station IP address setting status	0C02H(3074)
	IP ADD.L		Switch 4: Local station IP address setting status	0C03H(3075)
	DUO INFO		Switch 5: Redundant settings status	0C04H(3076)

*1: LED status structure

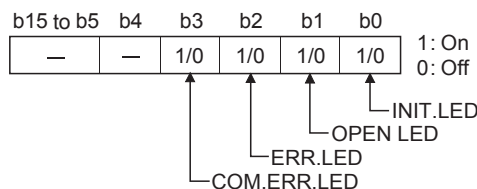

*2: Refer to Section 11.1 for troubleshooting of the H/W LED.

*3: Refer to Section 11.4 for how to turn off the COM. ERR. LED.

*4: Refer to Section 6.6 for details of the intelligent function module switches.

11.3 Error Codes

11.3.1 Error code storage areas

The error code of each error is stored into any of the following buffer memory areas.

Error Type		Storage Area Name		Address
Parameter error information	Basic parameter	Basic parameter error code storage area		0C10H (3088)
	Automatic communication parameter	Automatic communication parameter error code storage area		0C11H (3089)
		Automatic communication parameter setting result storage area		0C12H (3090)
	MODBUS [®] device assignment parameter	MODBUS [®] device assignment parameter error code storage area		0C13H (3091)
		MODBUS [®] device assignment parameter setting result storage area	Error, device type	0C14H (3092)
			Error, assigned group No.	0C15H (3093)
Master function	Automatic communication function	Automatic communication operation status storage area (parameter 1 to 64)		0C20H to 0C23H (3104 to 3107)
		Automatic communication error code storage area (parameter 1 to 64)		0C28H to 0C67H (3112 to 3175)
		Error log area		0CFEH to 0DFFH (3326 to 3583)
	Dedicated instruction	Error log area		0CFEH to 0DFFH (3326 to 3583)
Slave function		Error log area		0CFEH to 0DFFH (3326 to 3583)
GX Developer connection		Error log area		0CFEH to 0DFFH (3326 to 3583)
Communication status		Communication status of each protocol		0E10H to 0E8FH (3600 to 3727)

(1) Basic parameter error code storage area

- (a) When an error occurs with the basic parameter setting request (Y1) ON, the corresponding error code is stored in this area.
- (b) The error code is stored when the basic parameter setting, error completed (X2) turns ON.
- (c) The error code is cleared when the basic parameter setting, normally completed (X1) turns ON.

- (2) Automatic communication parameter error code storage area
 - (a) When an error occurs with the automatic communication parameter setting request/automatic communication start request (Y4) ON, the corresponding error code is stored in this area.
 - (b) The error code is stored when the automatic communication parameter setting, error completed (X5) turns ON.
 - (c) The error code is cleared when the automatic communication parameter setting, normally completed (X4) turns ON.

- (3) Automatic communication parameter setting result storage area
 - (a) When an automatic communication parameter error occurs with the automatic communication parameter setting request/automatic communication start request (Y4) ON, the automatic communication parameter number corresponding to the error is stored in this area.
 - (b) The automatic communication parameter number is stored when the automatic communication parameter setting, error completed (X5) turns ON.
 - (c) The automatic communication parameter number is cleared when the automatic communication parameter setting, normally completed (X4) turns ON.

- (4) MODBUS[®] device assignment parameter error code storage area
 - (a) When a MODBUS[®] device assignment parameter error occurs while the MODBUS[®] device assignment parameter setting request (Y8) is ON, the corresponding error code is stored in this area.
 - (b) The error code is stored when the MODBUS[®] device assignment parameter setting, error completed (X9) turns ON.
 - (c) The error code is cleared when the MODBUS[®] device assignment parameter setting, normally completed (X8) turns ON.

- (5) MODBUS[®] device assignment parameter setting result storage area
 - (a) When a MODBUS[®] device assignment parameter error occurs with the MODBUS[®] device assignment parameter setting request (Y8) ON, the device type and assigned group No. of the error device is stored in this area.
 - (b) The device type and assigned group No. are stored when the MODBUS[®] device assignment parameter setting, error completed (X9) turns ON.
 - (c) The device type and assigned group No. are cleared when the MODBUS[®] device assignment parameter setting, normally completed (X8) turns ON.
 - (d) The following values are stored to show the erroneous device type when the MODBUS[®] device assignment parameter setting, error completed (X9) is ON.

<Error devices and corresponding values>

 - Coil : 0001H
 - Input : 0002H
 - Input register : 0004H
 - Holding register : 0005H

(6) Automatic communication operation status storage area

(a) The operation statuses of the automatic communication function are stored in bit format in correspondence with the automatic communication parameters 1 to 64.

0: Operating normally (OFF)

The case where the automatic communication parameters are not set is also included.

1: Error occurred (ON)

(b) The operation statuses are stored into the bit positions, from low-order to high-order bits, in order of the automatic communication parameters 1 to 64.

	bF	bE	bD	bC	bB	bA	...	b5	b4	b3	b2	b1	b0
0C20 _H	16	15	14	13	12	11	...	6	5	4	3	2	1
0C21 _H	32	31	30	29	28	27	...	22	21	20	19	18	17
0C22 _H	48	47	46	45	44	43	...	38	37	36	35	34	33
0C23 _H	64	63	62	61	60	59	...	54	53	52	51	50	49

The numbers indicate the automatic communication parameter numbers.

(c) The operation status is set at the following timing.

- 1) When a response message (error completion) is received from a slave. (Only the corresponding bit turns ON.)
- 2) When a communication error occurs. (Only the corresponding bit turns ON.)

(d) The operation status is cleared at the following timing.

- 1) When a response message (normal completion) is received from a slave. (Only the corresponding bit turns ON.)
- 2) When the automatic communication function stops. (All bits turn OFF.)
- 3) When the power is turned off and then on again, or when the programmable controller CPU is reset. (All bits turn OFF.)

(e) Interlock with a target device

The automatic communication operation status storage area can be used as an interlock signal for a target device error.

Here is a program example.

1) Program condition

The QJ71MT91 is mounted in slot 0 of the base unit with the head I/O No. set to "0" and the automatic communication parameter 1 is used.

2) Program example

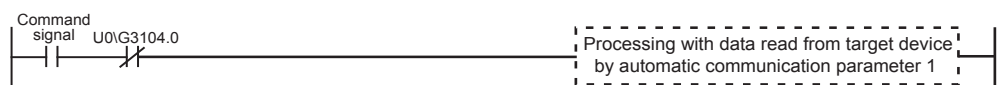

(7) Automatic communication function error code storage area

- (a) When an error occurs in the automatic communication function, the error code corresponding to the automatic communication parameter 1 to 64 is stored in this area.
- (b) When the automatic communication function operation status bit turns ON, the error code is stored into the corresponding area.
- (c) The automatic communication function error code storage area is not cleared.
The error code is overwritten when a new error occurs.

(8) Error log area

- (a) Up to 32 latest errors are stored into the error log area as an error history.

Error Log Area Name		Address
Number of errors occurred		0CFEH (3326)
Error log write pointer		0CFFH (3327)
Error log 1	Error code	0D00H (3328)
	Exception code	0D01H (3329)
	Function code	0D02H (3330)
	Local station port No.	0D03H (3331)
	Target IP address	0D04H to 0D05H (3332 to 3333)
	Target device port No.	0D06H (3334)
Error log 2 to 32 (as in error log 1)		0D08H to 0DFFH (3336 to 3583)

- (b) Number of errors occurred
 - 1) The number of errors entered into the error log is stored.
 - 2) If 65536 or more errors have occurred, the count stops at FFFFH (65535).
- (c) Error log write pointer
The number of the latest error log is stored.
0 : No error (no entry of error log)
1 to 32 : Error long number where the latest error log is entered

(d) Error log (error log 1 to 32)

- The error log area stores the 32 latest errors.
- The error log area stores the errors in order of occurrence, starting from the error log 1.
- If 33 or more errors have occurred, the error logs are overwritten, starting from the area of the error log 1.

Contents	Function				
	Master function		Slave function	GX Developer connection	Others
	Automatic communication	Dedicated instruction			
Error code	Stores a code corresponding to the error occurred at any timing such as during processing of a request message from the master, at power-on or when changing a MODBUS [®] device assignment parameter. Refer to Section 11.3.3 for the error codes.				
Exception code	Stores an exception code returned from a slave in reply to a request sent by the automatic communication function or dedicated instruction.		When an error occurs for a request from the master, stores an exception code returned to the master.	Stores "0".	
Function code	Stores the function code with which the error originated.			Stores "0".	
Local station port No.	Stores the local station port No. at error occurrence. Stores "0" for an error occurred below the TCP/UDP level, at power-on or in parameter setting.				
Target IP address	Stores an IP address of the target station at error occurrence. Stores "0" for an error occurred below the IP level, at power-on or in parameter setting.				
Target device port No.	Stores the port No. of the target station at error occurrence. Stores "0" for an error occurred below the TCP/UDP level, at power-on or in parameter setting.				

(9) Communication status of each protocol

(a) The numbers of corresponding events of each protocol are stored.

Error Name of Each Protocol		Address
IP	IP packet reception count	0E10 _H to 0E11 _H (3600 to 3601)
	Count of IP packet reception discarded due to sum check error	0E12 _H to 0E13 _H (3602 to 3603)
	Total number of sent IP packets	0E14 _H to 0E15 _H (3604 to 3605)
	Simultaneous transmission error detection count	0E2A _H to 0E2B _H (3626 to 3627)
ICMP	ICMP packet reception count	0E30 _H to 0E31 _H (3632 to 3633)
	Count of ICMP packet reception discarded due to sum check error	0E32 _H to 0E33 _H (3634 to 3635)
	Total number of sent ICMP packets	0E34 _H to 0E35 _H (3636 to 3637)
	Total number of ICMP echo request received	0E36 _H to 0E37 _H (3638 to 3639)
	Total number of ICMP echo reply sent	0E38 _H to 0E39 _H (3640 to 3641)
	Total number of ICMP echo request sent	0E3A _H to 0E3B _H (3642 to 3643)
	Total number of ICMP echo reply received	0E3C _H to 0E3D _H (3644 to 3645)
TCP	TCP packet reception count	0E50 _H to 0E51 _H (3664 to 3665)
	Count of TCP packet reception discarded due to sum check error	0E52 _H to 0E53 _H (3666 to 3667)
	Total number of sent TCP packets	0E54 _H to 0E55 _H (3668 to 3669)
UDP	UDP packet reception count	0E70 _H to 0E71 _H (3696 to 3697)
	Count of UDP packet reception discarded due to sum check error	0E72 _H to 0E73 _H (3698 to 3699)
	Total number of sent UDP packets	0E74 _H to 0E75 _H (3700 to 3701)
Receive error	Framing error count	0E84 _H to 0E85 _H (3716 to 3717)
	Overflow count	0E86 _H to 0E87 _H (3718 to 3719)
	CRC error count	0E88 _H to 0E89 _H (3720 to 3721)

(b) When 2 words are exceeded, a count stops at FFFFFFFF_H (4294967295).

11.3.2 Exception code list

An exception code is an error code commonly used for the MODBUS[®] protocols, which is embedded into a response message when the slave returns an exception response in reply to a request message from the master.

(1) When the QJ71MT91 is a master

When the QJ71MT91 (master) has received an exception code from the target device (slave), take corrective actions referring to the manual for the target device (slave).

(2) When the QJ71MT91 is a slave

When the target device (master) has received an exception code from the QJ71MT91 (slave), take corrective actions referring to the following.

(a) Exception code storage location

If the processing in the slave results in error completion, the exception code can be confirmed in the error log area (address: CFE_H to DFF_H) of the buffer memory.

(b) Exception code list

The following is a list of exception codes used when the QJ71MT91 is a slave.

Exception Code	Error Name	Description	Corrective Action	
			Target device (Master side)	QJ71MT91 (Slave side)
01 _H	Illegal function	The slave (QJ71MT91) received an unsupported function code.	Confirm the function code supported by QJ71MT91, and review the request message to be sent.	—
02 _H	Illegal data address	The specified address of the MODBUS [®] device is abnormal.	Confirm the MODBUS [®] device type and size supported by QJ71MT91, and review the specified address of the request message to be sent.	—
03 _H	Illegal data value	The contents of the data part of the request message are abnormal.	Review the data part of the request message.	—
04 _H	Slave device failure	A fatal error occurred while the slave (QJ71MT91) was attempting to perform the requested action and the processing was impossible.	Review the data part of the request message.	Remove the error factor in the QJ71MT91. If the QJ71MT91 issued this code, confirm the error code stored in the error log area (Refer to Section 11.3.1 (8)) and take corrective action.
05 _H	Acknowledge	As the slave is executing other processing, a long duration of time is required for completion of the request message processing.	Not issued by the slave function of the QJ71MT91.	
06 _H	Slave busy	As the slave is executing other processing, the request message processing cannot be executed.	Retry after a little while.	If the QJ71MT91 issued this code, the number of simultaneously acceptable request message (64) is exceeded.

Exception Code	Error Name	Description	Corrective Action	
			Target device (Master side)	QJ71MT91 (Slave side)
08 _H	Memory parity error	In the slave, a parity error was detected at access to the extended file register.		
0A _H	Gateway unusable	The gateway device (MODBUS [®] /TCP → MODBUS [®] serial protocol) is not available for use.	Not issued by the slave function of the QJ71MT91.	
0B _H	Gateway response failure	No response is given from the slave device connected ahead of the gateway device.		

(3) Error code for error completion of processing in slave (QJ71MT91)

If the processing in the slave (QJ71MT91) results in error completion, an exception code is stored into the buffer memory. In the QJ71MT91, an error code is also stored into the buffer memory to identify the cause in detail.

The error code can be confirmed in the error log area (address: CFE_H to DFF_H) of the buffer memory.

REMARK

- Refer to Section 11.3.1 (8) for details of the error log area.
- Refer to Section 11.3.3 for details of the error codes.

11.3.3 Error code list

When an error occurs in any processing of the QJ71MT91, the error code is stored into its buffer memory.

This section explains the error details and corrective actions to be taken at error occurrence.

The "Occurrence" field of the following error code table indicates that each of the errors may occur when:

- 1) The programmable controller is powered ON or the basic parameters are set
- 2) Master function is on
- 3) Slave function is on
- 4) GX Developer connection function is on or
- 5) During PING test or unit test.

Error Code	Error Name	Description	Lit LED	Corrective Action	Occurrence				
					1)	2)	3)	4)	5)
3E8H to 4FFFH	Error code issued by programmable controller CPU.		—	Refer to the QCPU User's Manual (Hardware Design, Maintenance and Inspection).	○	○	○	○	○
7301H	Switch 1 error	The setting of the intelligent function module switch 1 (operation mode setting) is incorrect.	ERR.	Review the setting of the intelligent function module switch 1.	○				
7302H	Switch 2 error	The setting of the intelligent function module switch 2 (communication condition setting) is incorrect.	ERR.	Review the setting of the intelligent function module switch 2.	○				
7303H	Switch 3, 4 error	The setting of the intelligent function module switch 3, 4 (IP address setting) is incorrect.	ERR.	Review the setting of the intelligent function module switch 3, 4.	○				
7305H	Switch 5 error	The setting of the intelligent function module switch 5 (redundant settings) is incorrect.	ERR.	<ul style="list-style-type: none"> • Review the setting of the intelligent function module switch 5. • When the redundant settings are not to be used, delete the setting of the intelligent function module switch 5. 	○				
7306H	ROM check error	An error was detected by the ROM check made at power-on.	ERR.	It is a QJ71MT91 hardware fault. Please consult your local Mitsubishi representative.	○				
7307H	RAM check error	An error was detected by the RAM check made at power-on.	ERR.	It is a QJ71MT91, programmable controller CPU or base unit failure. Please consult your local Mitsubishi representative.	○				
730AH	Parameter starting method error	Parameter setting using GX Configurator-MB was made to the programmable controller CPU while b0, b1 of the intelligent function module switch 2 (communication condition setting) was preset to "Start with the default parameters".	COM.ERR.	<ul style="list-style-type: none"> • When using the default parameter setting, delete the QJ71MT91 parameters set to the programmable controller CPU. • When starting the QJ71MT91 with user setting parameters set from GX Configurator-MB or sequence program, turn ON b0, b1 of the intelligent function module switch 2. 	○				

(Continued on next page)

Error Code	Error Name	Description	Lit LED	Corrective Action	Occurrence					
					1)	2)	3)	4)	5)	
730BH	Parameter starting method error	After power-on with parameters preset by GX Configurator-MB, before Basic parameter setting existence (X3) turns on, parameter settings were done by any of the following: <ul style="list-style-type: none"> • Basic parameter setting request (Y1) • Automatic communication parameter setting request /automatic communication start request (Y4) • MODBUS[®] device assignment parameter setting request (Y8) 	COM.ERR.	When using parameters set by GX Configurator-MB, do not make parameter settings by Y-signals before Basic parameter setting existence (X3) turns on after power-up.	○					
7310H	Monitoring timer setting error	Any of the monitoring timer setting in the basic parameter is incorrect.	COM.ERR.	Review the monitoring timer setting.	○					
7311H	Preferred node specification setting error	The setting of the preferred node specification in the basic parameter is incorrect.	COM.ERR.	Review the setting of the preferred node specification.	○					
7312H	Subnet mask pattern setting error	The setting of the subnet mask pattern in the basic parameter is incorrect.	COM.ERR.	Review the setting of the subnet mask pattern.	○					
7313H	Default router IP address setting error	The setting of the default router IP address in the basic parameter is incorrect.	COM.ERR.	Review the setting of the default router IP address.	○					
7314H	Subnet address setting error	The setting of the subnet address in the basic parameter is incorrect.	COM.ERR.	Review the setting of the subnet address.	○					
7315H	Router IP address setting error	<ul style="list-style-type: none"> • The setting of the router IP address in the basic parameter is incorrect. • The net ID of the local station differs from the net ID of the router IP address. 	COM.ERR.	Review the setting of the router IP address.	○					
7316H	Number of routers setting error	The setting of the number of routers set in the basic parameter is incorrect.	COM.ERR.	Review the setting of the number of routers set.	○					
7317H	KeepAlive setting error	The KeepAlive-related setting in the basic parameter is incorrect.	COM.ERR.	Review the KeepAlive-related setting.	○					
7318H	Number of TCP connections for GX Developer connection setting error	The setting of the number of TCP connections for GX Developer connection in the basic parameter is incorrect.	COM.ERR.	Review the setting of the number of TCP connections for GX Developer connection.	○					
7319H	Local slave station port No. error	The setting of the local slave station port No. in the basic parameter is incorrect.	COM.ERR.	Review the setting of the local slave station port No.	○					

(Continued on next page)

Error Code	Error Name	Description	Lit LED	Corrective Action	Occurrence				
					1)	2)	3)	4)	5)
731A _H	Number of TCP connections setting error	The number of TCP connections for GX Developer connection or the total number of TCP connections set in the preferred node specification in the basic parameter is greater than 64.	COM.ERR.	Review the setting of the number of TCP connections for GX Developer connection and preferred node specification.	○				
731B _H	Timer setting magnitude relationship error	The magnitude relationships between various monitoring timer values and CPU response monitoring timer value set in the basic parameters (Refer to Section 7.2.2 (1)) are incorrect.	COM.ERR.	Review the settings of various monitoring timer values and CPU response monitoring timer value.	○				
7320 _H	Port No. setting error for automatic communication function	The setting of the port No. for automatic communication function in the basic parameter is incorrect.	COM.ERR.	Review the setting of the port No. for automatic communication function.	○				
7321 _H	Target slave port No. setting error for automatic communication function	The setting of the target slave port No. for automatic communication function in the basic parameter is incorrect.	COM.ERR.	Review the setting of the target slave port No. for automatic communication function.	○				
7324 _H	System area setting error	Erroneous data have been written to the system area (0031 _H to 00F1 _H) of the buffer memory.	COM.ERR.	Do not write data to the system area (0031 _H to 00F1 _H) of the buffer memory.	○				
7327 _H	CPU response monitoring timer setting error	The setting of the CPU response monitoring timer in the basic parameter is incorrect.	COM.ERR.	Review the setting of the CPU response monitoring timer.	○				
732A _H	Basic parameter setting failure	Failed in basic parameter setting because the GX Configurator-MB parameters were being set at power-on.	COM.ERR.	When using GX Configurator-MB, switch the power on and then turn on Basic parameter setting request (Y1) after Basic parameter setting existence (X3) has turned on.	○				
732E _H	Port No. setting error for dedicated instruction	The setting of the port No. for dedicated instruction in the basic parameter is incorrect.	COM.ERR.	Review the setting of the port No. for dedicated instruction.	○				
732F _H	Dedicated instruction interruption	The dedicated instruction being executed was interrupted by the basic parameter setting.	COM.ERR.	Perform the basic parameter setting after completion of the dedicated instruction.	○				
7330 _H	Device code error	The device code value specified in MODBUS [®] device assignment parameter is incorrect.	COM.ERR.	Review the setting of the device code.			○		

(Continued on next page)

Error Code	Error Name	Description	Lit LED	Corrective Action	Occurrence				
					1)	2)	3)	4)	5)
7331H	MODBUS [®] device upper limit value over error	The head MODBUS [®] device number + assignment points in the MODBUS [®] device assignment parameter exceeds the maximum (65535) of the MODBUS [®] device.	COM.ERR.	Review the setting of the head MODBUS [®] device number and assignment points.			○		
7332H	MODBUS [®] device assigned range overlap error	MODBUS [®] device ranges set with the MODBUS [®] device assignment parameters are overlapped.	COM.ERR.	Review the setting of the head MODBUS [®] device number and assignment points.			○		
7333H	Buffer memory assigned range error	The assigned range of the QJ71MT91 buffer memory set with the MODBUS [®] device assignment parameters exceeds the set range of the user free area.	COM.ERR.	Review the setting of the head device number and assignment points.			○		
7334H	Device upper limit value over error	The head device number + assignment points in the MODBUS [®] device assignment parameter exceeds the maximum (65535) of the CPU device.	COM.ERR.	Review the setting of the head device number and assignment points.			○		
7340H	Target MODBUS [®] device type specification error	The setting of the target MODBUS [®] device type specification in the automatic communication parameter is incorrect.	COM.ERR.	Review the setting of the target MODBUS [®] device type specification.		○			
7343H	Response monitoring timer setting error	The setting of the response monitoring timer in the automatic communication parameter is outside the setting range.	COM.ERR.	Review the setting of the response monitoring timer so that it falls within the setting range.		○			
7344H		The setting of the response monitoring timer in the automatic communication parameter is less than the setting of the split reception monitoring timer value.	COM.ERR.	Make the response monitoring timer greater than the split reception monitoring timer value.		○			
7345H	Buffer memory address overlap error	The setting ranges of the buffer memory in the automatic communication parameter overlap between multiple parameters.	COM.ERR.	Correct the overlapping buffer memory settings.		○			

(Continued on next page)

Error Code	Error Name	Description	Lit LED	Corrective Action	Occurrence				
					1)	2)	3)	4)	5)
7346 _H	Buffer memory address range error	The setting range of the buffer memory in the automatic communication parameter is outside the range of the automatic communication function buffer input/output area.	COM.ERR.	Correct the buffer memory setting outside the range.		○			
7347 _H	IP address setting error	The setting of the target IP address set in the automatic communication parameter or dedicated instruction's control data is incorrect.	COM.ERR.	Review the setting of the IP address.		○			
7348 _H	MODBUS [®] device number setting range error	The MODBUS [®] device range of the read/write target set in the automatic communication parameter or dedicated instruction's control data is greater than the maximum value (65536).	COM.ERR.	Review the setting range of the MODBUS [®] device.		○			
7349 _H	MODBUS [®] device points setting error	The MODBUS [®] device range of the read/write target set in the automatic communication parameter or dedicated instruction's control data is outside the setting range.	COM.ERR.	Review the setting range of the MODBUS [®] device.		○			
734A _H	Module ID setting error	The setting of the module ID set in the automatic communication parameter or dedicated instruction's control data is incorrect.	COM.ERR.	Review the setting of the module ID.		○			
734B _H	Execution type setting error	The setting of the execution type set in the dedicated instruction's control data is incorrect.	COM.ERR.	Review the setting of the execution type.		○			
734C _H	Response monitoring timer setting error	The setting of the response monitoring timer in the dedicated instruction's control data is outside the setting range.	COM.ERR.	Review the setting of the response monitoring timer so that it falls within the setting range.		○			
734D _H		The setting of the response monitoring timer in the dedicated instruction's control data is less than the setting of the split reception monitoring timer value.	COM.ERR.	Make the response monitoring timer greater than the split reception monitoring timer value.		○			
734E _H	Write data storage size setting error	The setting of the write data storage size in the dedicated instruction's control data is incorrect.	COM.ERR.	Review the setting of the write data storage size.		○			

(Continued on next page)

Error Code	Error Name	Description	Lit LED	Corrective Action	Occurrence				
					1)	2)	3)	4)	5)
734FH	Request message size setting error	The request message size specified in the argument ((S2)+0) of the MBREQ instruction is incorrect.	COM.ERR.	Review the setting of the request message size.		○			
7351H	Automatic communication function start interruption	The start of the automatic communication function was interrupted due to the processing of the basic parameter setting.	COM.ERR.	After turning ON the Automatic communication parameter setting request/Automatic communication start request (Y4), do not turn ON the Basic parameter setting request (Y1) until the Automatic communication operation status (X6) turns ON.		○			
7352H	Basic parameter not set	The automatic communication function was started or stopped without the basic parameter being set.	COM.ERR.	Start or stop the automatic communication function with Basic parameter setting existence (X3) on.		○			
		The automatic communication function was started when parameter setting was being made on GX Configurator-MB at power-on.	COM.ERR.	When using GX Configurator-MB, switch the power on and then turn on Automatic communication parameter setting request/Automatic communication start request (Y4) after Basic parameter setting existence (X3) has turned on.		○			
7353H	Redundant setting error	When the QJ71MT91 on the main base unit of a redundant system is mounted, the automatic communication function of the master function was attempted to be executed.	COM.ERR.	Delete the automatic communication parameter setting. (When mounting the QJ71MT91 on the main base unit of a redundant system, the master function cannot be used.)		○			
7360H	Exception message reception	When the automatic communication function or dedicated instruction is used, the target slave device returned an exception code in reply to the request message sent by the QJ71MT91.	COM.ERR.	<ul style="list-style-type: none"> Refer to the exception code returned from the target slave device, and resolve the problem. Resolve the problem that occurred in the target slave device. 		○			
7361H	Byte count error	In the automatic communication function or dedicated instruction, the number of bytes in the received response message is less or more than necessary.	COM.ERR.	On the target slave side, check whether the contents of the returned response message are correct or not.		○			
7362H	Reference number error	The value of the reference number in the response message received by the dedicated instruction is incorrect.	COM.ERR.			○			

(Continued on next page)

Error Code	Error Name	Description	Lit LED	Corrective Action	Occurrence				
					1)	2)	3)	4)	5)
7363 _H	Protocol ID error	In the automatic communication function or dedicated instruction, the protocol ID of the received response message is other than "0: MODBUS [®] protocol".	COM.ERR.	On the target slave side, check whether the contents of the returned response message are correct or not.		○			
7365 _H	Module ID mismatch error	In the automatic communication function or dedicated instruction, the "module ID" in the MBAP header of the received response message does not match the request message.	COM.ERR.			○			
7366 _H	Function code mismatch error	In the automatic communication function or dedicated instruction, the function code of the received response message does not match the request message.	COM.ERR.			○			
7367 _H	Response message contents mismatch error	In the automatic communication function or dedicated instruction, the contents of the received response message does not match the request message. (FC: 15, FC: 16, FC: 21)	COM.ERR.			○			
7370 _H	Automatic communication function stop request error	The automatic communication stop request (Y6) was made with the automatic communication function stopped.	COM.ERR.	When the automatic communication function is stopped, do not make the automatic communication stop request (Y6).		○			
7371 _H	Automatic communication parameter setting request error	The automatic communication parameter setting request/automatic communication start request (Y4) was made with the automatic communication function ON.	COM.ERR.	After stopping the automatic communication function, make the automatic communication parameter setting request/automatic communication start request (Y4).		○			
7378 _H	Response monitoring timer time-out error	The response monitoring timer timed out in the automatic communication function.	COM.ERR.	<ul style="list-style-type: none"> • Conduct a PING test, etc. to check whether the target device exists or not. • If an error has occurred in the target device, remove the error. • Set a larger response monitoring timer value. 		○			
7379 _H	Response monitoring timer time-out error	The response monitoring timer timed out in the dedicated instruction.	COM.ERR.				○		

(Continued on next page)

Error Code	Error Name	Description	Lit LED	Corrective Action	Occurrence					
					1)	2)	3)	4)	5)	
737A _H	Dedicated instruction execution impossible	<ul style="list-style-type: none"> • Since the basic parameters have not yet been set, the dedicated instruction cannot be executed. • The dedicated instruction cannot be executed due to the offline mode. • Since the QJ71MT91 on the main base unit of a redundant system have been mounted, the dedicated instruction cannot be executed. (When mounting the QJ71MT91 on the main base unit of a redundant system, the master function cannot be used.) 	COM.ERR.	<ul style="list-style-type: none"> • Execute the dedicated instruction after setting the basic parameters. • Execute the dedicated instruction in the online mode. • To use the dedicated instruction in a redundant system, mount the QJ71MT91 on the extension base unit and delete the setting of the intelligent function module switch 5. 		○				
7380 _H	CPU response monitoring timer time-out	The CPU response monitoring timer timed out in the slave function.	COM.ERR.	<ul style="list-style-type: none"> • If an error has occurred in the programmable controller CPU, remove the error. • Set a larger CPU response monitoring timer value. 			○			
7381 _H	Function code error	The request message of the function code not supported by the QJ71MT91 slave function was received.	COM.ERR.	Confirm the function code supported by the QJ71MT91 slave function, and review the request message to be sent.			○			
7382 _H	Sub-code error	The request message of the sub-code not supported by the QJ71MT91 slave function was received.	COM.ERR.	Confirm the sub-code supported by the QJ71MT91 slave function, and review the request message to be sent.			○			
7383 _H	MODBUS [®] device specification error	The MODBUS [®] device assignment parameters have not been set for the MODBUS [®] device specified in the received request message. The MODBUS [®] device assignment parameter setting is in process.	COM.ERR.	<ul style="list-style-type: none"> • Set the MODBUS[®] device assignment parameters for the MODBUS[®] device specified in the received request message. • Adjust the timing for the request message transmission on the master side so that communication is started after the MODBUS[®] device assignment parameter setting existence (XA) turns ON. 			○			
7384 _H		The range of the MODBUS [®] device specified in the received request message is outside the MODBUS [®] device assignment parameter setting range.	COM.ERR.	Set the MODBUS [®] device assignment parameter so that the MODBUS [®] device specified in the received request message is within the range.			○			

(Continued on next page)

Error Code	Error Name	Description	Lit LED	Corrective Action	Occurrence				
					1)	2)	3)	4)	5)
7385 _H	MODBUS [®] device specification error	The range of the MODBUS [®] device specified in the received request message exceeds the maximum value* of the MODBUS [®] device. *: The maximum value of the extended file register is "10000", and that of any other MODBUS [®] device is "65536".	COM.ERR.	Review the specified data of the MODBUS [®] device on the master side from which the request message was sent.			○		
7386 _H		The access points of the MODBUS [®] device specified in the received request is greater than the maximum access points of the corresponding function.	COM.ERR.	Review the specified data of the MODBUS [®] device on the master side from which the request message was sent.			○		
7390 _H	Byte count specification error	The write points of the received request message does not match the specified byte count.	COM.ERR.	Review the specified data of the write points and byte count on the master side from which the request message was sent.			○		
7391 _H	Received data size error	The write device data size of the received request message does not match the specified byte count.	COM.ERR.	Review the specified data of the write device data size and byte count on the master side from which the request message was sent.			○		
7392 _H	Reference type error	The reference number value specified in the received request message (FC: 20, FC: 21) is incorrect.	COM.ERR.	Review the specified reference number value on the master side from which the request message was sent.			○		
7393 _H	Data unit error	<ul style="list-style-type: none"> The contents of the data unit in the received request message are incorrect. The size of the received request message is smaller than the minimum size or greater than the maximum size required for the relevant function code. 	COM.ERR.	Review the contents of the request message on the master side from which the request message was sent.			○		
7394 _H	Online change error	A write request message was received in an online change disable status.	COM.ERR.	<ul style="list-style-type: none"> While online change is disabled, do not issue a write request message. Turn ON b2 of the intelligent function module switch 2 (communication condition setting) to enable the online change. 			○		
7395 _H	MBAP header error	The contents of the MBAP header in the received request message are incorrect.	COM.ERR.	Review the contents of the request message on the master side from which the request message was sent.			○		

(Continued on next page)

Error Code	Error Name	Description	Lit LED	Corrective Action	Occurrence				
					1)	2)	3)	4)	5)
7396 _H	Slave function busy	The QJ71MT91 received request messages that exceed the number of simultaneously receivable request messages (64).	COM.ERR.	Retry after a little while on the master side from which the request message was sent.			○		
739C _H to 739E _H	System error	The OS of the QJ71MT91 detected error.	COM.ERR.	Counter the problem in the following procedure. <ul style="list-style-type: none"> • Check whether or not the QJ71MT91, power supply module and CPU module are mounted correctly on the base unit. • Check whether or not the operating environment of the system is within the range of general specifications of the CPU module. • Check whether the power capacity is sufficient or not. • Check the QJ71MT91, CPU module and base unit to see if the hardware is normal according to the manual of each module. • If the module is faulty, please consult your local Mitsubishi representative. • If the problem cannot be resolved in the above steps, please consult your local Mitsubishi representative. 	○	○	○	○	○
73B1 _H	PING test setting error	The settings (communication time check, transmission count, IP address) of the PING test are incorrect.	COM.ERR.	Review the settings of the PING test.					○

(Continued on next page)

Error Code	Error Name	Description	Lit LED	Corrective Action	Occurrence				
					1)	2)	3)	4)	5)
73C0 _H	RAM error	An error was detected in the RAM test.	ERR.	Counter the problem in the following procedure. <ul style="list-style-type: none"> • Check whether or not the QJ71MT91, power supply module and CPU module are mounted correctly on the base unit. • Check whether or not the operating environment of the system is within the range of general specifications of the CPU module. • Check whether the power capacity is sufficient or not. • Perform the test again. • If the above does not solve the problem, a probable cause is a hardware error. Check if the programmable controller CPU and base unit are normal referring to the manual for each module. Or, replace either of the modules to check the operation. In case of failure, please consult your local Mitsubishi representative. 					○
73C1 _H	ROM error	An error was detected in the ROM test.	ERR.						○
73C2 _H	Self-loopback test error	An error was detected in the self-loopback test.	COM.ERR.						○
73C8 _H	Offline mode error	In the offline mode, parameters were set by GX Configurator-MB.	COM.ERR.	In the offline mode, delete GX Configurator-MB parameters set in the programmable controller CPU.	○				
73C9 _H		In the offline mode, Basic parameter setting request (Y1) was turned on.	COM.ERR.	Do not turn on Basic parameter setting request (Y1) in the offline mode.	○				
73CA _H		In the offline mode, Automatic communication parameter setting request/Automatic communication start request (Y4) was turned on.	COM.ERR.	Do not turn on Automatic communication parameter setting request/Automatic communication start request (Y4) in the offline mode.		○			
73CB _H		In the offline mode, Automatic communication stop request (Y6) was turned on.	COM.ERR.	Do not turn on Automatic communication stop request (Y6) in the offline mode.		○			
73CC _H		In the offline mode, MODBUS [®] device assignment parameter setting request (Y8) was turned on.	COM.ERR.	Do not turn on MODBUS [®] device assignment parameter setting request (Y8) in the offline mode.			○		
73CD _H		In the offline mode, PING test execution request (Y1C) was turned on.	COM.ERR.	Do not turn on PING test execution request (Y1C) in the offline mode.					○

(Continued on next page)

Error Code	Error Name	Description	Lit LED	Corrective Action	Occurrence				
					1)	2)	3)	4)	5)
73D0 _H	Response message transmission failure	As the TCP connection was cut off from the target device, the slave function of the QJ71MT91 could not send a response message.	COM.ERR.	<ul style="list-style-type: none"> Check whether the operation status of the target device is normal or not. Check the line status for an error. 			○		
73D1 _H		As the TCP connection was cut off from the target device, the response message could not be returned via GX Developer connection.	COM.ERR.	<ul style="list-style-type: none"> Check whether the operation status of the target device is normal or not. Check the line status for an error. 				○	
73D2 _H	Preferred connection count over error	TCP connections exceeding the number preset in the preferred node specification was attempted to be established.	COM.ERR.	<ul style="list-style-type: none"> Increase the maximum number of TCP connections with the target node in the preferred node specification. Decrease the number of connections simultaneously used with the target node. 		○	○	○	
73D3 _H	Response message transmission failure	As the TCP connection was cut off from the target device, the response message via GX Developer connection could not be returned.	COM.ERR.	<ul style="list-style-type: none"> Check whether the operation status of the target device is normal or not. Check the line status for an error. 				○	
73D4 _H	Send/receive processing interruption	The send/receive processing was forcibly interrupted by the basic parameter setting processing.	COM.ERR.	Perform the basic parameter setting processing after the send/receive processing is over.	○	○	○	○	
		An error occurred in the TCP connection and the send/receive processing was forcibly interrupted.	COM.ERR.	<ul style="list-style-type: none"> Retry after a little while. Check whether the operation status of the target device is normal or not. Check the line status for an error. 	○	○	○	○	
73D5 _H	Send/receive processing interruption	As the TCP connection was being closed, the send/receive processing was interrupted.	COM.ERR.	<ul style="list-style-type: none"> If this occurs at execution of the dedicated instruction, set "TCP connection is not closed after instruction completion" in the close option of the execution type. If the number of connections used exceeds the maximum (64), bring it within the range. Check whether the operation status of the target device is normal or not. Check the line status for an error. Retry after a little while. 	○	○	○	○	
73D6 _H	Send/receive processing interruption	The send/receive processing was forcibly interrupted by the basic parameter setting processing.	COM.ERR.	Perform the basic parameter setting processing after the send/receive processing is over.	○	○	○	○	

(Continued on next page)

Error Code	Error Name	Description	Lit LED	Corrective Action	Occurrence					
					1)	2)	3)	4)	5)	
73D7H	Error during close processing	Transmission through the connection being closed was attempted.	COM.ERR.	<ul style="list-style-type: none"> • Retry after a little while. • If this error occurs at execution of the dedicated instruction, set "TCP connection is not closed after instruction completion" in the close option of the control data. 		○	○	○		
73D8H	Open failure	Failed to open the TCP connection for the request message transmission.	COM.ERR.	<ul style="list-style-type: none"> • Check whether the operation status of the target device is normal or not. • Check the open status of the target device. • Review the IP address, port No. setting and other parameters of the target device. • Check the line status for an error. 		○	○	○		
73D9H		Since the normal connection resources were all being used, a new TCP connection could not be opened.	COM.ERR.	<ul style="list-style-type: none"> • Retry after a little while. • Decrease the number of TCP connections used simultaneously. 		○	○	○		
73DAH	Alive check failure (KeepAlive function)	Since the existence of the target device could not be confirmed by the KeepAlive function, the TCP connection was disconnected.	COM.ERR.	<ul style="list-style-type: none"> • Check whether the operation status of the target device is normal or not. • Check the line status for an error. 		○	○	○		
7400H	Target device port No. error	The port number setting of the target device is erroneous.	COM.ERR.	Review the port number setting of the target device at the time of transmission.		○	○	○		
7401H	Target device IP address error	The IP address setting of the target device is erroneous.	COM.ERR.	Review the IP address setting of the target device at the time of transmission.		○	○	○	○	
7402H	Open failure	A TCP connection was not established in the open processing.	COM.ERR.	<ul style="list-style-type: none"> • Check whether the operation status of the target device is normal or not. • Check the open status of the target device. • Review the IP address, port No. setting and other parameters of the target device. • Check the line status for an error. 		○	○	○		
7403H	Send error	A send error occurred.	COM.ERR.	<ul style="list-style-type: none"> • Check whether the operation status of the target device is normal or not. • Check the line status for an error. • As the line may be busy, retry after a little while. • Hardware fault. 		○	○	○	○	

(Continued on next page)

Error Code	Error Name	Description	Lit LED	Corrective Action	Occurrence				
					1)	2)	3)	4)	5)
7404 _H	Receive error	A receive error occurred.	COM.ERR.	<ul style="list-style-type: none"> • Check whether the operation status of the target device is normal or not. • Check the line status for an error. • Hardware fault. 		○	○	○	○
7405 _H		The internal receive buffer has no free space.	COM.ERR.	<ul style="list-style-type: none"> • Retry after a little while. • Check whether the operation status of the target device is normal or not. • Check the line status for an error. • Hardware fault. 		○	○	○	○
7410 _H	Send error	A send error occurred.	COM.ERR.	<ul style="list-style-type: none"> • Check whether the operation status of the target device is normal or not. • Check the line status for an error. • As the line may be busy, retry after a little while. • Hardware fault. 		○	○	○	○
7420 _H	Broadcast address specification error	The broadcast address was specified in TCP-based transmission.	COM.ERR.	Review the IP address setting of the target device at the time of transmission.		○		○	
7421 _H	Ethernet address error	The Ethernet address of the target device is unknown.	COM.ERR.	<ul style="list-style-type: none"> • Review the IP address of the target device at the time of transmission. • Check whether the target device with the specified IP address exists on the line or not. • Check whether the operation status of the target device is normal or not. • Check the line status for an error. • As the line may be busy, retry after a little while. • Replace the target device with the one having the ARP function. 		○	○	○	○
7422 _H	IP check sum error	A check sum error was detected in the IP protocol.	COM.ERR.	<ul style="list-style-type: none"> • Check whether the operation status of the target device is normal or not. • Check the line status for an error. 		○	○	○	○

(Continued on next page)

Error Code	Error Name	Description	Lit LED	Corrective Action	Occurrence				
					1)	2)	3)	4)	5)
7423 _H	ICMP error packet reception	The error packet of ICMP was received.	COM.ERR.	<ul style="list-style-type: none"> Review the setting of the router information. Check whether the router operates normally. Check the router communication path for any error. Check the communication path ahead of the router for any error. Review the IP address of the target device at the time of transmission. Check whether the target device with the specified IP address exists on the line or not. As the line may be busy, retry after a little while. Review the IP reassembly timer value of the target device. 					
7424 _H									
7425 _H									
7426 _H									
7427 _H									
7428 _H									
7429 _H									
742A _H									
742B _H									
742C _H									
742D _H	Router relay function error	<ul style="list-style-type: none"> Without the routing information setting of the basic parameter, data were attempted to be sent to the target device that has a different IP address class or net ID. The routing information setting of the basic parameter is erroneous. 	COM.ERR.	<ul style="list-style-type: none"> Review the IP address of the target device at the time of transmission. Review the setting of the routing information. Review the setting of the subnet mask pattern. 					
7440 _H	UDP check sum error	A check sum error was detected in the UDP protocol.	COM.ERR.	<ul style="list-style-type: none"> Check whether the operation status of the target device is normal or not. Check the line status for an error. 					
7450 _H	TCP ULP time-out error	<ul style="list-style-type: none"> The TCP ULP timer timed out. ACK is not returned from the target device. 	COM.ERR.	<ul style="list-style-type: none"> Check whether the operation status of the target device is normal or not. Check the line status for an error. As the line may be busy, retry after a little while. Review the TCP ULP timer value of the basic parameter. 					
7451 _H	TCP check sum error	A check sum error was detected in the TCP protocol.	COM.ERR.	<ul style="list-style-type: none"> Check whether the operation status of the target device is normal or not. Check the line status for an error. 					

(Continued on next page)

Error Code	Error Name	Description	Lit LED	Corrective Action	Occurrence					
					1)	2)	3)	4)	5)	
7452 _H	Connection not open	<ul style="list-style-type: none"> Transmission was attempted using the connection not open. The connection used to send data was already closed. 	COM.ERR.	<ul style="list-style-type: none"> Check whether the operation status of the target device is normal or not. Check the line status for an error. Retry after a little while. 		○	○	○		
7453 _H		The connection being closed was used to send data.		Retry after a little while.						
7454 _H	Connection being closed	The connection not open was used to send data.	COM.ERR.	Retry after a little while.		○	○	○		
7455 _H	TCP receive data size error	The message greater than the TCP maximum size was received.	COM.ERR.	<ul style="list-style-type: none"> Check whether the operation status of the target device is normal or not. Check the line status for an error. 		○	○	○		
7460 _H	TCP ULP time-out error	As the TCP ULP timer timed out, the TCP connection was forcibly disconnected from the local station.	COM.ERR.	<ul style="list-style-type: none"> Check whether the operation status of the target device is normal or not. Check the line status for an error. As the line may be busy, retry after a little while. Review the TCP ULP timer value of the basic parameter. 		○	○	○		
7461 _H	TCP connection forcibly disconnected	The TCP connection was disconnected forcibly from the target device. (This error may be ignored when no problems arise from this error.)	COM.ERR.	<ul style="list-style-type: none"> Check whether the operation status of the target device is normal or not. Check the line status for an error. As the line may be busy, retry after a little while. 		○	○	○		
7462 _H	TCP connection forcibly disconnected	<ul style="list-style-type: none"> The TCP connection was closed forcibly from the local station. The local station uses 64 or more TCP connections. Hence, the TCP connection was closed forcibly to maintain the TCP connections available for simultaneous opening under frequently opened and closed conditions. (This error may be ignored when no problems arise from this error.) 	COM.ERR.	<ul style="list-style-type: none"> In the preferred node specification, specify the target device with which communication is made frequently. Decrease the number of TCP connections used simultaneously. Check whether the operation status of the target device is normal or not. Check the line status for an error. As the line may be busy, retry after a little while. 		○	○	○		
7463 _H	TCP protocol error	As a TCP protocol error was detected, the TCP connection was closed forcibly.	COM.ERR.	<ul style="list-style-type: none"> Check whether the operation status of the target device is normal or not. Check the line status for an error. 		○	○	○		
7471 _H	UDP receive data size error	The message greater than the UDP maximum size was received.	COM.ERR.	<ul style="list-style-type: none"> Check whether the operation status of the target device is normal or not. Check the line status for an error. 				○	○	

(Continued on next page)

Error Code	Error Name	Description	Lit LED	Corrective Action	Occurrence				
					1)	2)	3)	4)	5)
7472 _H	IP address setting error	The host address bits of the IP address of the request message transmission destination are all "0" or all "1".	COM.ERR.	Correct the target IP address set to the dedicated instruction's control data or automatic communication parameter.		○	○	○	
7473 _H	Connection not open	<ul style="list-style-type: none"> The connection not open was used to send data. The connection used to send data was already closed. 	COM.ERR.	<ul style="list-style-type: none"> Check whether the operation status of the target device is normal or not. Check the line status for an error. Retry after a little while. 		○	○	○	
7474 _H	TCP connection forcibly disconnected	The TCP connection was disconnected forcibly from the target device. (This error may be ignored when no problems arise from this error.)	COM.ERR.	<ul style="list-style-type: none"> Check whether the operation status of the target device is normal or not. Check the line status for an error. As the line may be busy, retry after a little while. 		○	○	○	
7475 _H									
7480 _H to 75FF _H	System error	The OS of the QJ71MT91 detected error.	COM.ERR.	<p>Counter the problem in the following procedure.</p> <ul style="list-style-type: none"> Check whether or not the QJ71MT91, power supply module and CPU module are mounted correctly on the base unit. Check whether or not the operating environment of the system is within the range of general specifications of the CPU module. Check whether the power capacity is sufficient or not. Check the QJ71MT91, CPU module and base unit to see if the hardware is normal according to the manual of each module. <p>If the module is faulty, please consult your local Mitsubishi representative.</p> <ul style="list-style-type: none"> If the problem cannot be resolved in the above steps, please consult your local Mitsubishi representative. 	○	○	○	○	○

REMARK

- (1) Refer to Section 11.3.1 for the error code storage areas.
- (2) Refer to Chapter 7 for details of the parameter setting ranges, etc.

11.4 Turning Off the COM. ERR. LED

This section explains how to turn off the COM. ERR. LED of the QJ71MT91 when it is lit.

POINT
(1) Remove possible error cause before turning off the COM.ERR. LED. (Refer to Section 11.1, 11.3) If not, the following operation will not turn off the COM.ERR. LED.
(2) The COM. ERR. LED turns on when an error occurs. Once the COM. ERR. LED has turned on, it does not turn off automatically even if the status returns to normal. Use the following method to turn off the COM. ERR. LED.

Method	Reference Section
From GX Configurator-MB	Section 11.4.1
From sequence program	Section 11.4.2

11.4.1 From GX Configurator-MB

This section explains how to turn off the COM. ERR. LED from GX Configurator-MB.

- (1) Display the **Monitor/Test** screen. (Refer to Section 8.6)

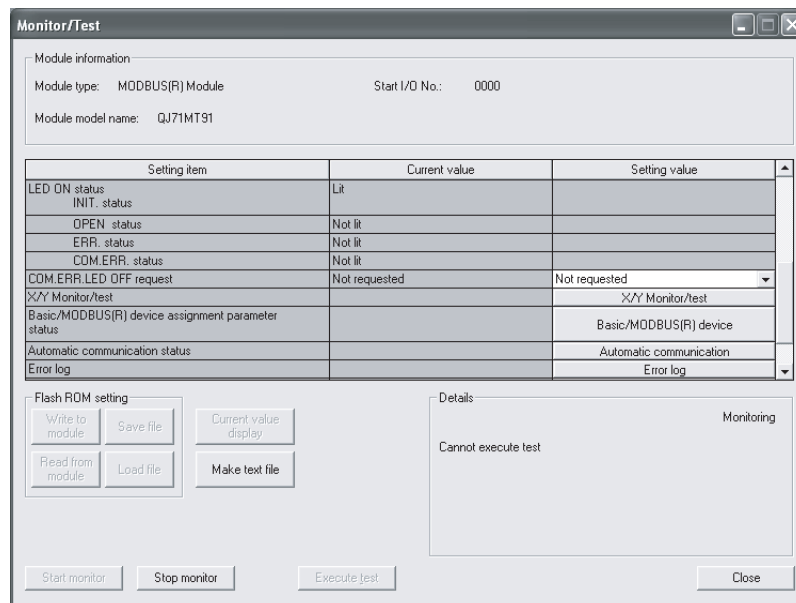

(2) Turn off the COM. ERR. LED.

In the Setting value field of the "COM. ERR. LED OFF request", select "Being requested" and click the **Execute test** button.

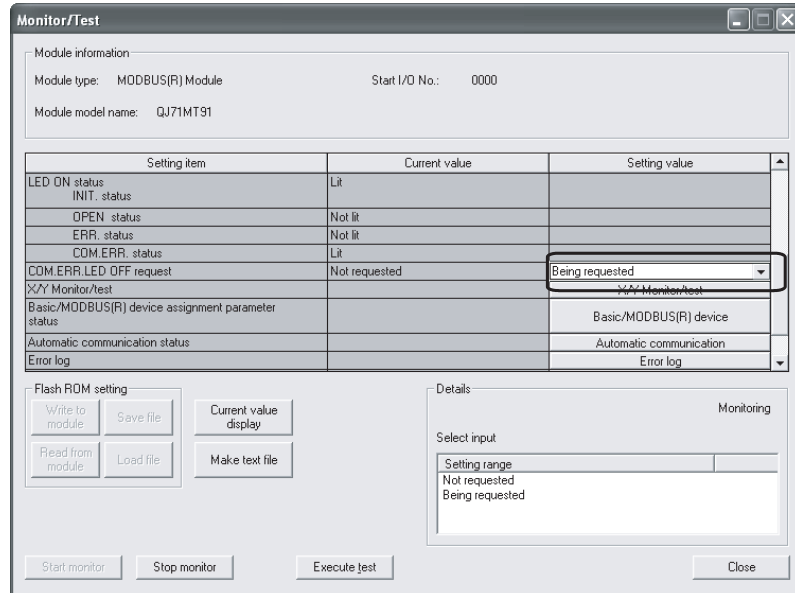

(3) Confirm the COM. ERR. LED is turned off.

When the processing is completed, a "Completed." message appears.

Confirm that the Current value field of "COM. ERR. status" has changed from "Lit" to "Not lit".

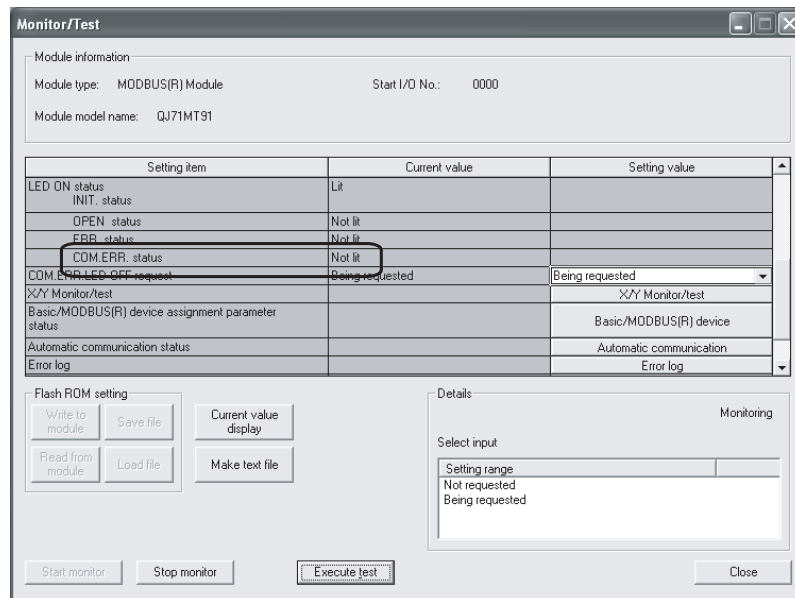

- (4) Change the Current value field of the "COM. ERR. LED OFF request" back to "Not requested".

Because the "COM. ERR. LED OFF request" current value does not return to "Not requested" automatically after turn-off of the COM. ERR. LED, it must be manually returned to "Not requested" after the COM. ERR. LED has turned off.

After confirming "Not lit", select "Not requested" in the "COM. ERR. LED OFF request" setting value field and click the **Execute test** button.

When the processing is completed, a "Completed." message appears.

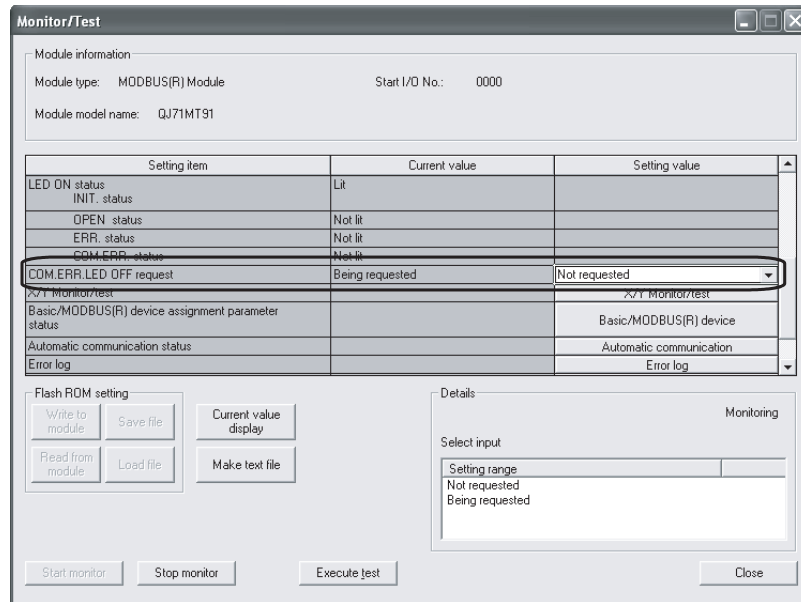

- (5) Confirm the "COM. ERR. LED OFF request" current value.

The "COM. ERR. LED OFF request" current value must be as shown below.

- "COM. ERR. LED OFF request" current value → "Not requested"

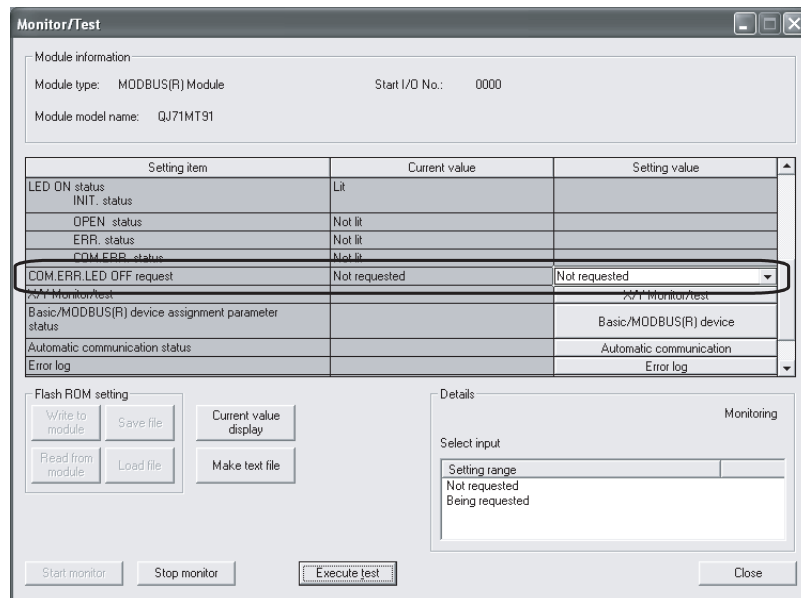

11.4.2 Program example for use of sequence program

This section explains how to turn off the COM. ERR. LED from a sequence program.

(1) Relationship between COM.ERR. LED and I/O signals

Upon occurrence of a communication error, the COM.ERR. LED (COM.ERR. LED status (X1B): ON) on the front of the QJ71MT91 turns ON. (1) in the figure)

(a) Turn ON the COM.ERR. LED OFF request (Y1B) to turn OFF the COM.ERR. LED. (2) in the figure)

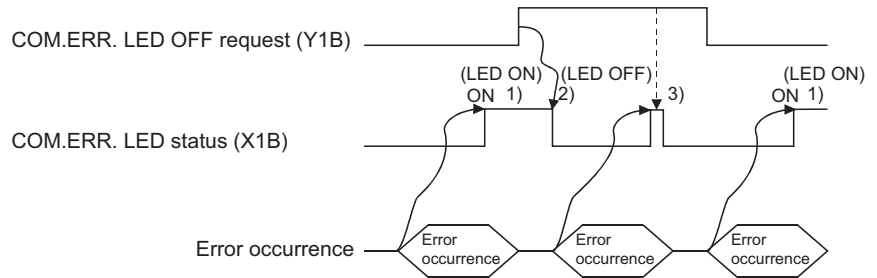

(b) While the COM.ERR. LED OFF request (Y1B) is ON, OFF request processing is performed continuously. (3) in the figure)

(c) The error information in the error log area of the buffer memory is not cleared (erased) by turning ON the COM.ERR. LED OFF request (Y1B).

(2) Program conditions

In this program, COM. ERR. LED OFF request (Y1B) is turned on to turn off the COM. ERR. LED.

Device Name	Device	Application	
QJ71MT91 input/output	Input	X0	Module READY
		X1B	COM. ERR. LED status
	Output	Y1B	COM. ERR. LED OFF request
External input (command)	X20	COM. ERR. LED OFF command	

(3) Program example

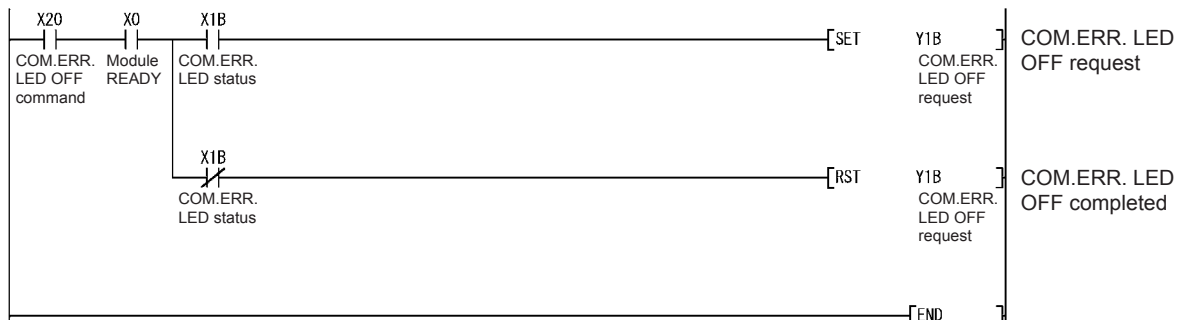

11.5 Conducting PING Test to Check QJ71MT91 Connection

This section explains how to conduct a PING test in the QJ71MT91.

Method	Reference Section
From GX Configurator-MB	Section 11.5.1
From sequence program	Section 11.5.2

(1) PING test

- (a) A PING test checks whether the other QJ71MT91 or MODBUS® /CP device exists or not on Ethernet (same subnet address) where the QJ71MT91 is connected, or if a target device (personal computer) having the specified IP address exists or not.
- (b) Perform a PING test to check the following.
 - 1) Whether the QJ71MT91 is correctly connected to the other device on the line.
 - 2) Whether the basic parameter setting of the QJ71MT91 is correct.

(2) Buffer memory addresses used for PING test

The following buffer memory addresses are used for a PING test.

Address	Parameter Name	Setting	Setting Range	Default
0FE0H (4064)	Communication time check	Specify the waiting time for completion of the PING test. Set time = set value × 500ms	2 to 60	2
0FE1H (4065)	Transmission count	Specify the number of transmissions.	1 to 10	4
0FE2H to 0FE3H (4066 to 4067)	IP address	Specify the IP address of the PING test target device.	Refer to *1	00000000H
0FE4H (4068)	PING test execution results	Execution result	• The execution result of the PING test is stored. • When completed with an error, the error code is stored. (Refer to Section 11.3.3)	0000H: Normal completion 0001H to : Error completion (Error code)
0FE5H (4069)		Total packet transmission count	The total packet transmission count, success count and failure count for the PING test execution are stored.	—
0FE6H (4070)		Success count		—
0FE7H (4071)		Failure count		—

*1: Set the value that satisfies the following conditions.

Condition 1: The IP address class is any of A, B and C.

Condition 2: The host address bits are not all "0" or all "1".

11.5.1 From GX Configurator-MB

This section explains how to conduct a PING test from GX Configurator-MB.

- (1) Display the **PING test** screen. (Refer to Section 8.6)

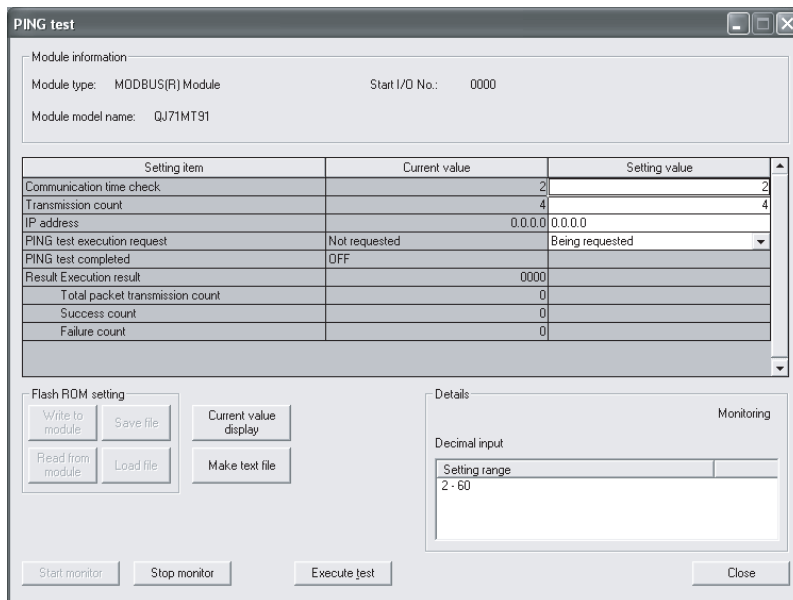

- (2) Set the PING test conditions.

Set the "Communication time check", "Transmission count" and "IP address" in the Setting value field, and click the **Execute test** button with the values selected.

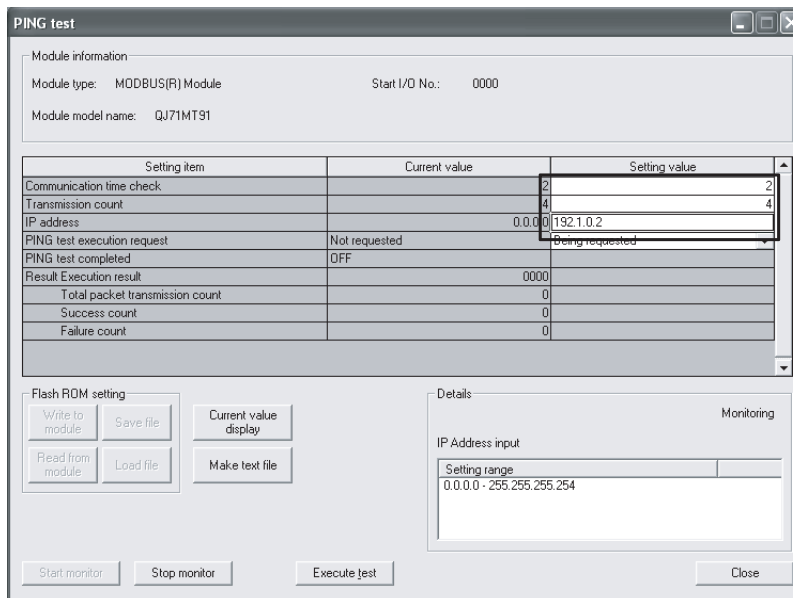

- (3) Confirm the conditions set in (2).

When the processing is completed, a "Completed." message appears, and the data set in (2) are displayed in the Current value field.
Redo the settings if changing the conditions.

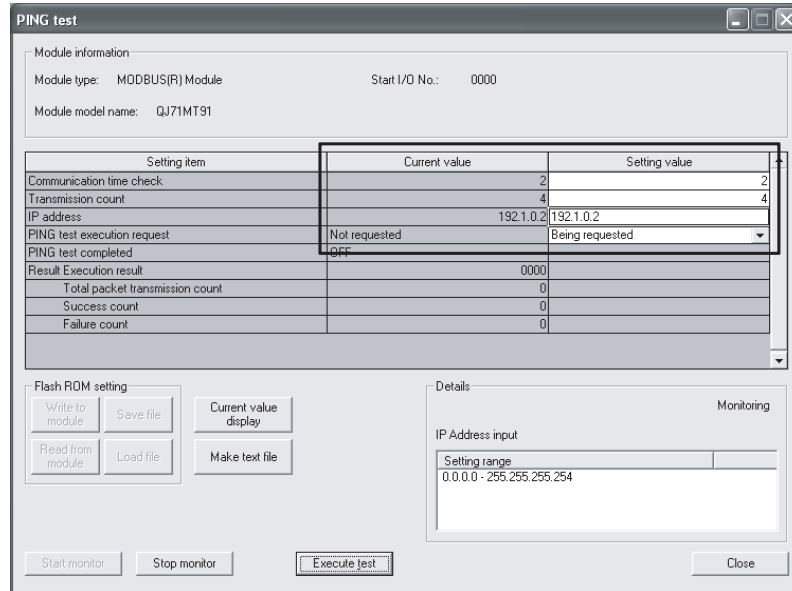

- (4) Conduct a PING test.

Select "Being requested" in the "PING test execution request" setting value field, and click the **Execute test** button.
When the processing is completed, a "Completed." message appears and the PING test is executed.

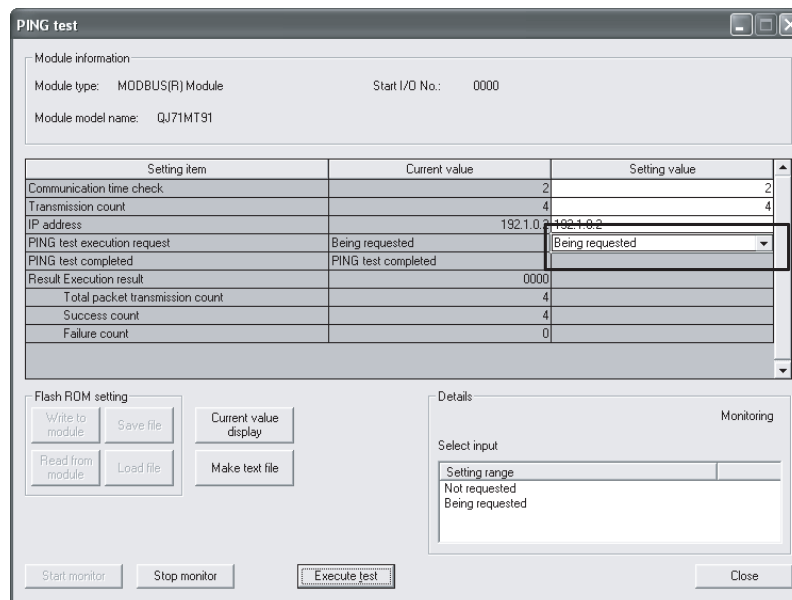

- (5) Check the status during PING test execution.
 - "PING test execution request" current value → "Being requested"
 - "PING test completed" current value → "OFF"

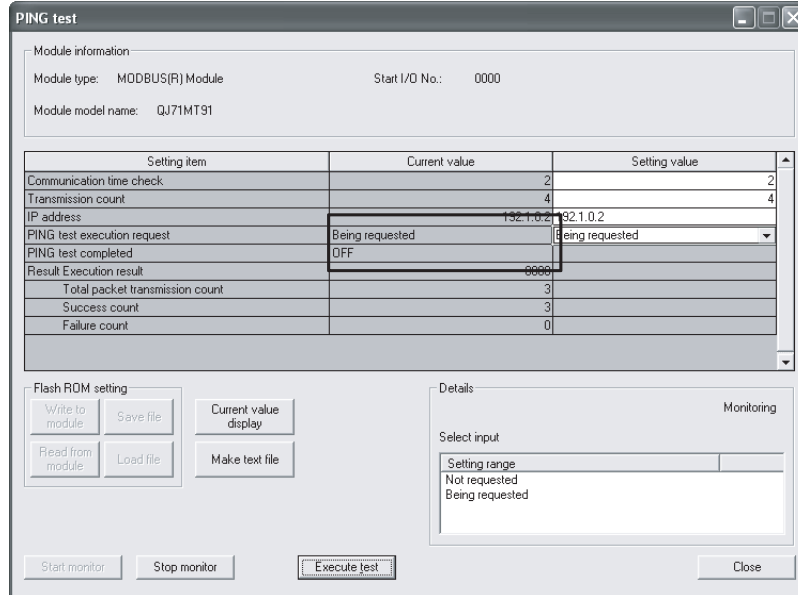

- (6) Check the status when the PING test is completed.
 - "PING test execution request" current value → "Being requested"
 - "PING test completed" current value → "PING test completed"
 - "Result" current value → Result is displayed for each.

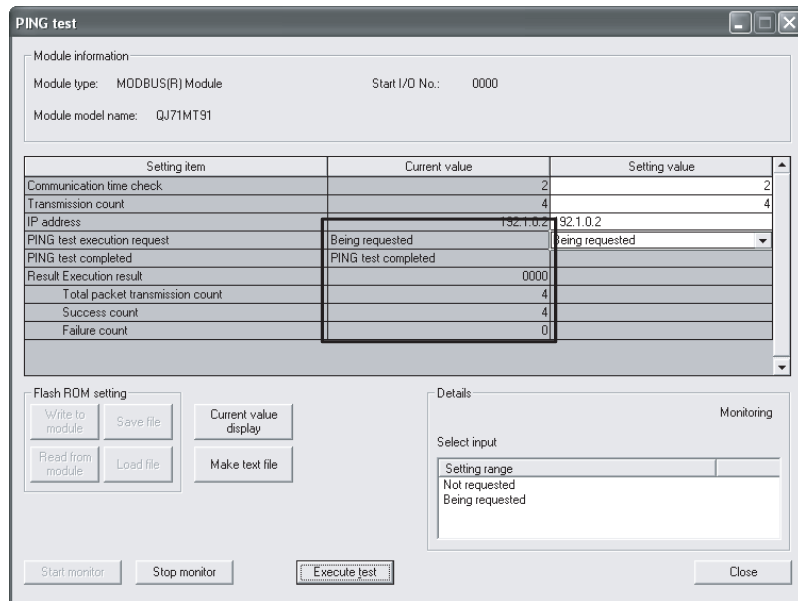

- (7) Change the "PING test execution request" current value back to "Not requested". Because the "PING test execution request" current value does not automatically return to "Not requested" on completion of the PING test, it must be manually changed to "Not requested" after the PING test is completed. Select "Not requested" in the "PING test execution request" setting field and click the **Execute test** button. When the processing is completed, a "Completed." message appears.

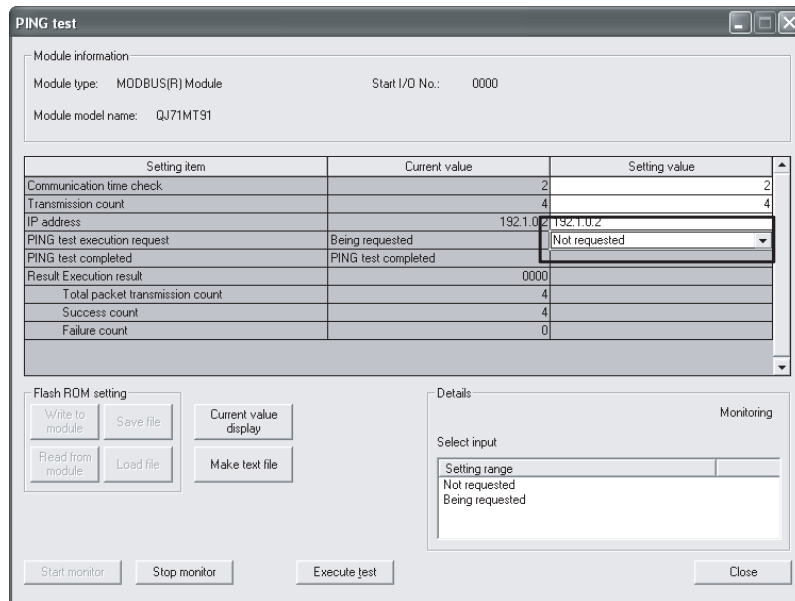

- (8) Confirm the "PING test execution request" current value. The "PING test execution request" current value must be as shown below.
- "PING test execution request" current value → "Not requested"
 - "PING test completed" current value → "OFF"

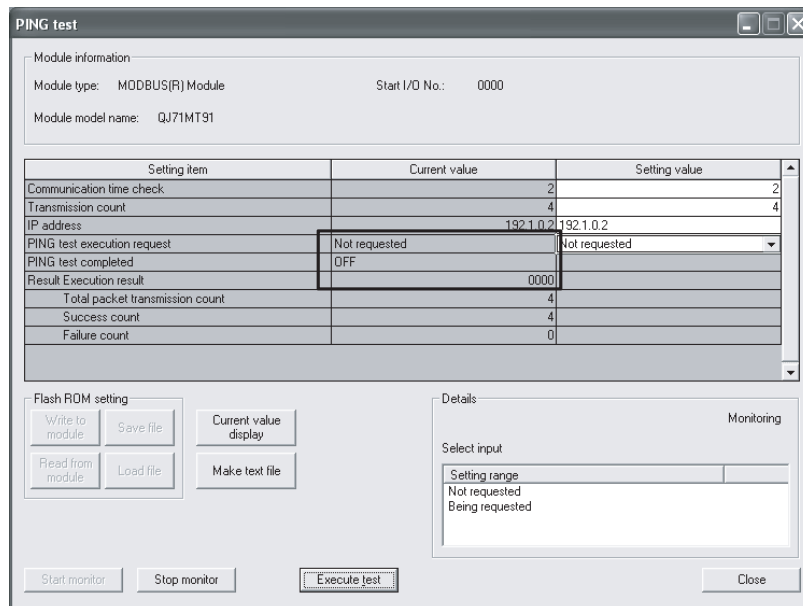

11.5.2 Program example for use of sequence program

This section explains how to perform a PING test from a sequence program.

(1) Relationship between PING test and I/O signals

- (a) Turn ON the PING test execution request (Y1C) to execute the PING test. (1) in the figure)

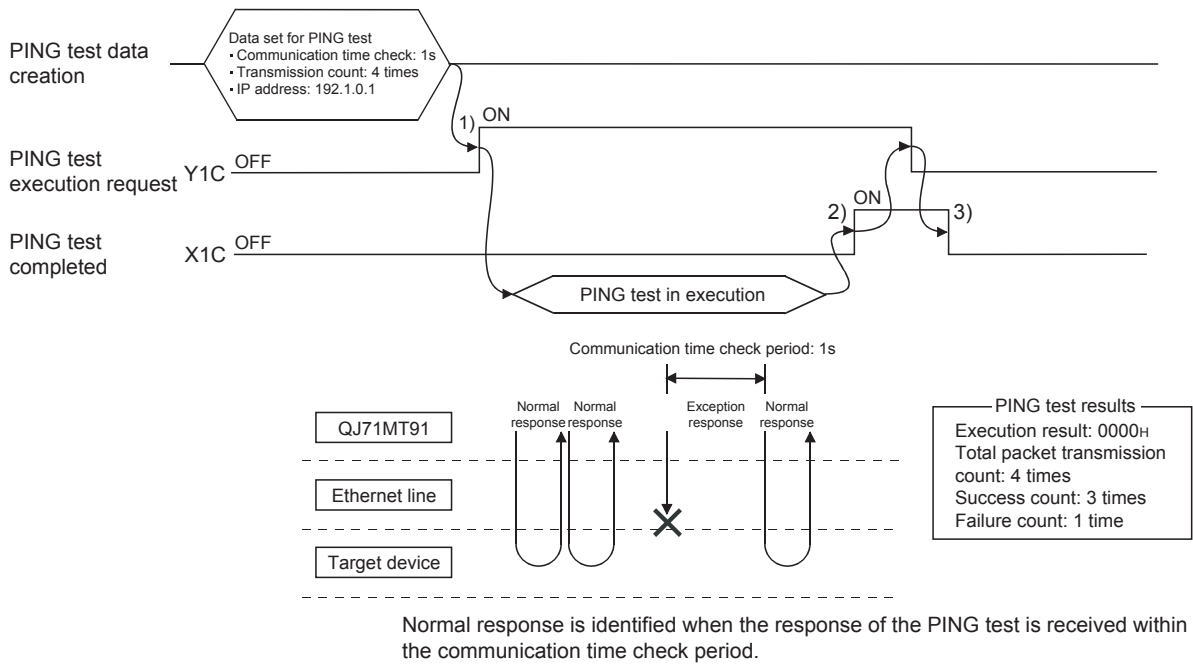

- (b) On completion of the PING test, the PING test completion (X1C) turns ON. (2) in the figure)
- (c) Turn OFF the PING test execution request (Y1C) to turn OFF the PING test completion (X1C). (3) in the figure)

(2) Error completion of PING test

- (a) The execution result of the PING test is stored into the execution result area (0FE5H).
When error completion arises, the error code is stored.
For the corrective actions to be taken at error completion, refer to Section 11.3.3
- (b) If the basic parameter setting request (Y1) is turned ON during execution of the PING test, the PING test results in error completion.
- (c) If the PING test is executed with the basic parameter setting request (Y1) ON, the PING test results in error completion.

(3) Program example

An example of the PING test performed with a sequence program is given below.

(a) System configuration

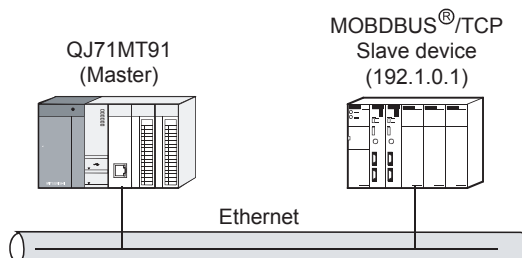

*1: The QJ71MT91 is mounted on Slot 0 of the base unit, and the head I/O No. is 0.

(b) Program conditions

This program executes a PING test when PING test execution request (Y1C) is turned on after the PING test conditions are set.

1) PING test condition settings

Setting Item	Buffer Memory Address	Set Value
Communication time check	0FE0H (4064)	2 (1s)
Transmission count	0FE1H (4065)	4 (4 times)
IP address	0FE2H to 0FE3H (4066 to 4067)	C0010001H (192.1.0.1)

2) Devices available for user

Device Name	Device	Application	
QJ71MT91 input/output	Input	X0	Module READY
		X3	Basic parameter setting existence
		X1C	PING test completed
QJ71MT91 input/output	Output	Y1C	PING test execution request
		External input (command)	X20
Data register	D10000	For getting execution result	
	D10001	For getting total packet transmission count	
	D10002	For getting success count	
	D10003	For getting failure count	
Intelligent function module device	U0\G4064	Communication time check	
	U0\G4065	Transmission count	
	U0\G4066 to U0\G4067	IP address	
	U0\G4068	Execution result	
	U0\G4069	Total packet transmission count	
	U0\G4070	Success count	
	U0\G4071	Failure count	

(c) Program example

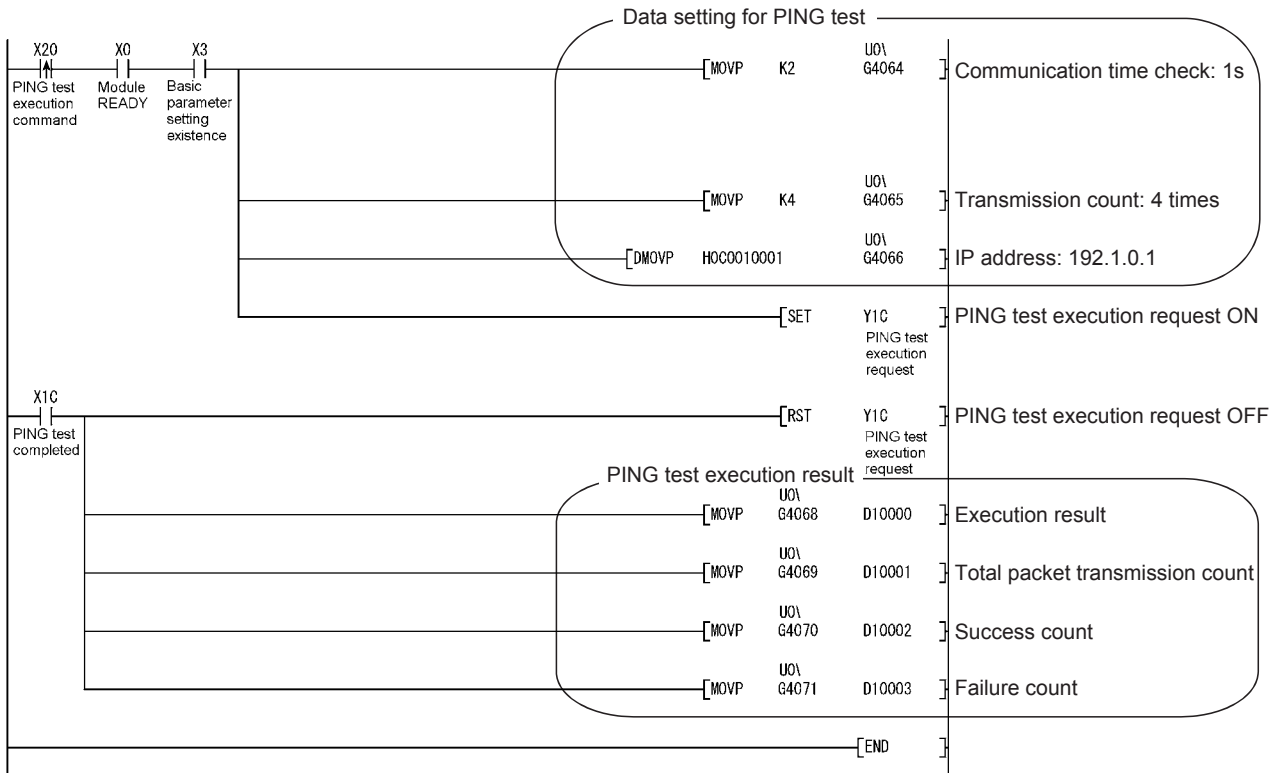

APPENDICES

Appendix 1 External Dimensions

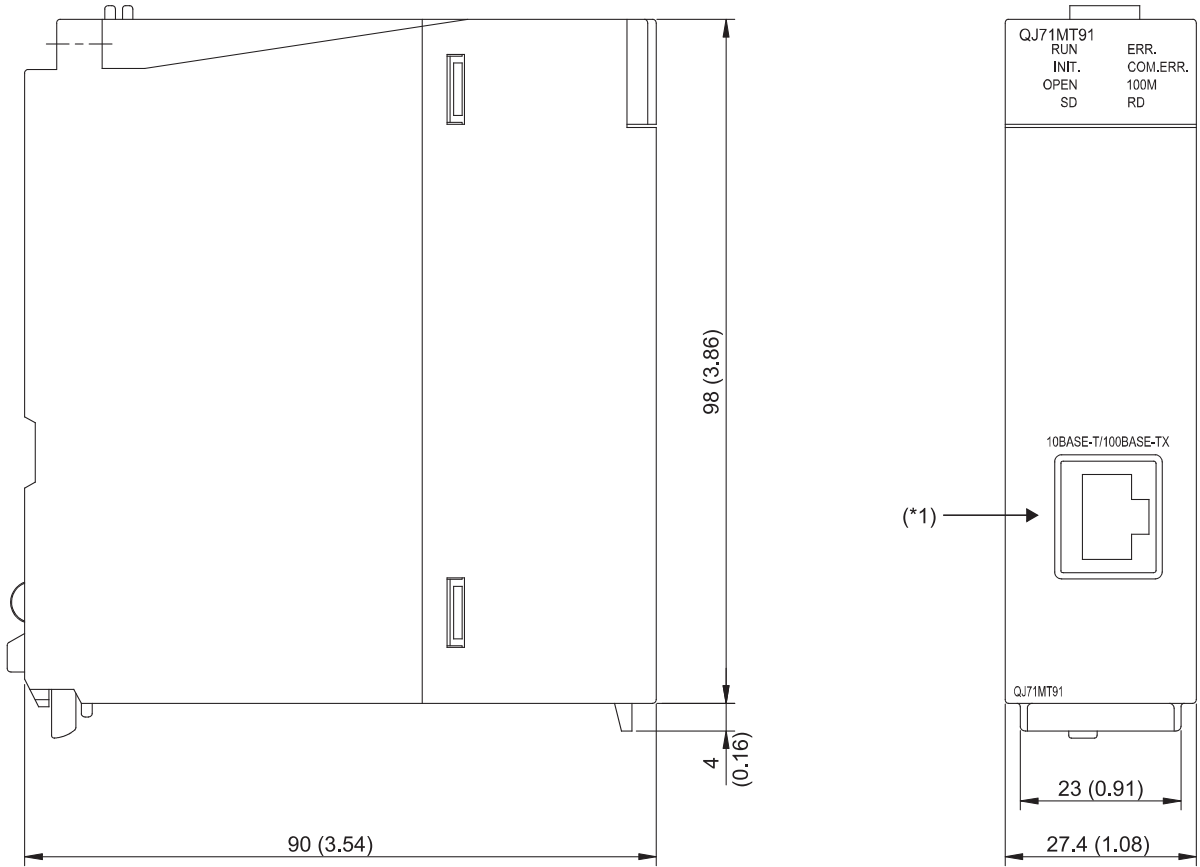

(Unit: mm (in.))

*1: Depending on the serial number, the connector orientation is left-right reversal.

Appendix 2 Function Upgrade of the QJ71MT91

The QJ71MT91 version has been upgraded with a new function added.
The new function and the supported version are shown below.

New function	Supported version
Redundant system function	Function version D or later

APP

Appendix 3 Processing Time

This section explains the processing time of the QJ71MT91 by function.
The processing time of the QJ71MT91 may become longer than that calculated in this section depending on the network load factor (line congestion), number of TCP connections used simultaneously, and GX Developer connection existence.
Refer to the processing time calculated by the expression in this section when having the QJ71MT91 communicate with one target device using an already established TCP connection.

(1) Master function performance

(a) Automatic communication function performance

1) Automatic communication function communication time [Unit: ms]

The automatic communication function communication time is the time from when the repeat interval timer expires until the repeat interval timer is started again after completion of communication with the slave.

$$T_{ac} = 7 + T_s$$

2) Calculation items

Setting Item	Description	Unit
T _{ac}	Automatic communication function communication time	ms
T _s	Target slave device processing time	ms

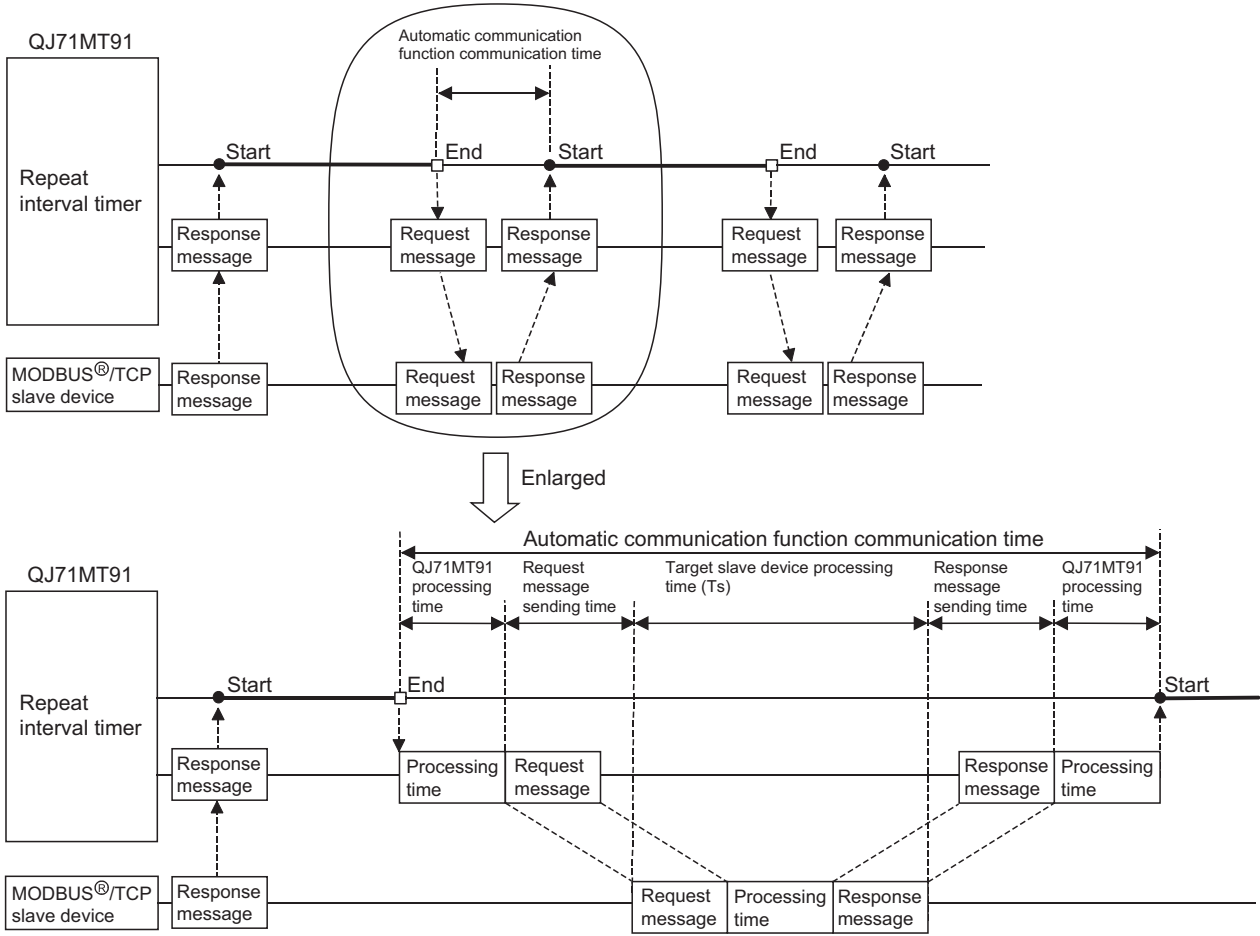

(b) Dedicated instruction performance (MBRW/MBREQ instruction)

1) Dedicated instruction processing time [Unit: ms]

The dedicated instruction processing time is the time from when the dedicated instruction is started until the completed device turns on.

$$Trc = 7 + St + (St \text{ or } Ts, \text{ whichever is greater})$$

2) Calculation items

Setting Item	Description	Unit
Trc	Dedicated instruction processing time	ms
St	Local station scan time	ms
Ts	Message processing time at destination slave device	ms

(2) Slave function performance

1) Request message processing time [Unit: ms]

The request message processing time is the time from when the QJ71MT91 receives a request message from the master until it sends a response message after completion of processing.

$$T_{sl} = 5 + 7 \times n_1 + St \times n_2$$

2) Calculation items

Setting Item	Description			Unit	
Tsl	Request message processing time			ms	
St	Local station scan time			ms	
n1	Any of the following values is applied depending on the function code and assignment status.			—	
	Function code	When programmable controller CPU device is assigned			When buffer memory is assigned
	01	1			0
	02	1			0
	03	1			0
	04	1			0
	05	1			0
	06	1			0
	15	1			0
	16	1			0
	20	1			0
	21	1			0
	22	2			0
	23	2			0
n2	Any of the following values is applied depending on the function code and assignment status.			—	
	Function code	When programmable controller CPU device is assigned			When buffer memory is assigned
		Normal case	Worst case		
	01	1	2		0
	02	1	2		0
	03	1	2		0
	04	1	2		0
	05	1	2		0
	06	1	2		0
	15	1	2		0
	16	1	2		0
	20	1	2		0
	21	1	2		0
	22	2	4		0
23	2	4	0		

Appendix 4 GX Developer Connection Setup Example

This section explains the setting of the GX Developer connection setup window when access is made from GX Developer to the programmable controller CPU via the QJ71MT91.

For details of GX Developer, refer to the GX Developer Operating Manual.

(1) Access route

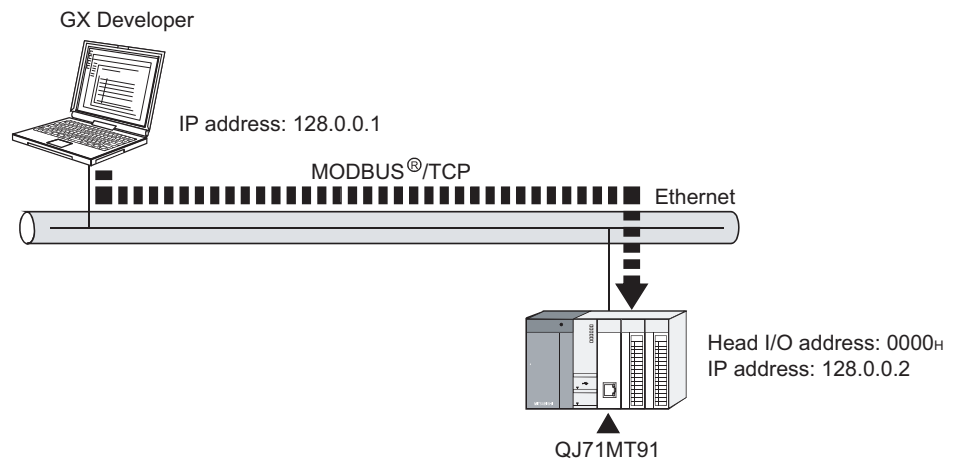

(2) Connection setup window

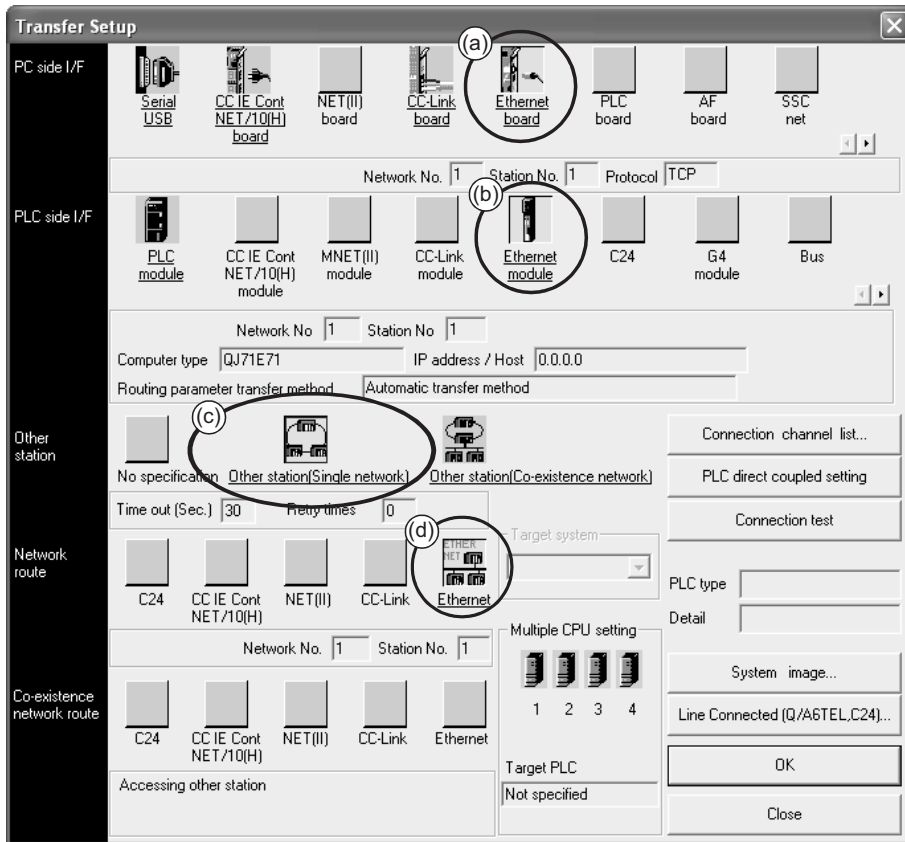

(a) PC side I/F

- 1) Select "Ethernet board" and double-click it to display the "PC side I/F Ethernet board setting" screen.
- 2) Set "Protocol" on the "PC side I/F Ethernet board setting" screen.
 - Protocol • • • • • Select "TCP" or "UDP".
- 3) Since "Network No." and "Station No." are not used, leave them as displayed on the screen.

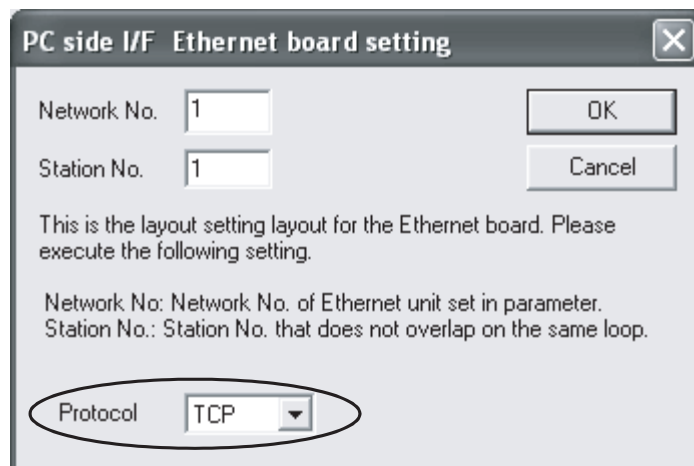

(b) PLC side I/F

- 1) Select "Ethernet module" and double-click it to display the "PLC side I/F detailed setting of Ethernet module" screen.
- 2) Set "PLC" and "IP address" on the "PLC side I/F detailed setting of Ethernet module" screen.
 - PLC Select "QJ71E71".
 - IP address Set the IP address of the QJ71MT91 to be connected.
 - IP input format ... Select "DEC." or "HEX.".
- 3) Since "Station No." and "Routing parameter transfer method" are not used, leave them as displayed on the screen.

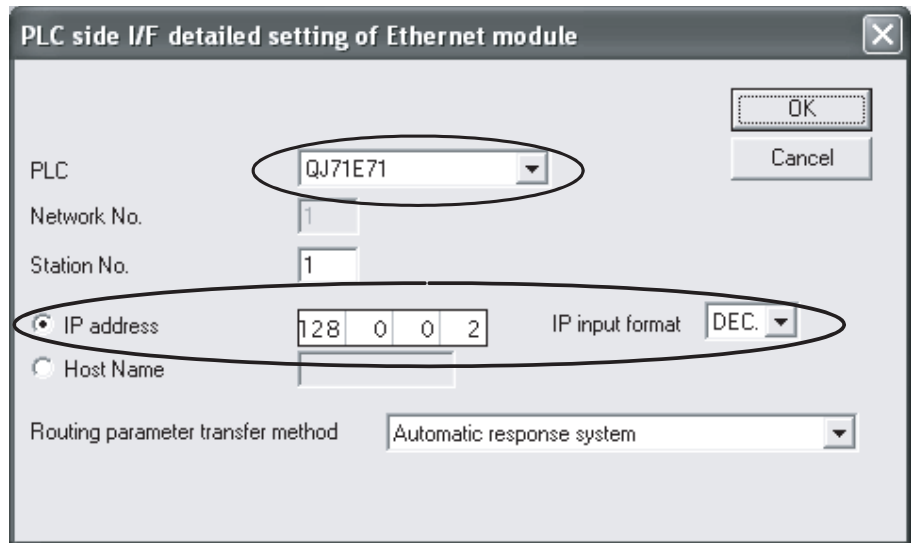

(c) Other station

Select "Other station (Single network)".

(d) Network route

- 1) Select "Ethernet" and double-click it to display the "Network communication route Detailed setting of Ethernet" screen.
- 2) Select "Access to Ethernet module set on PLC side I/F" on the "Network communication route Detailed setting of Ethernet" screen.

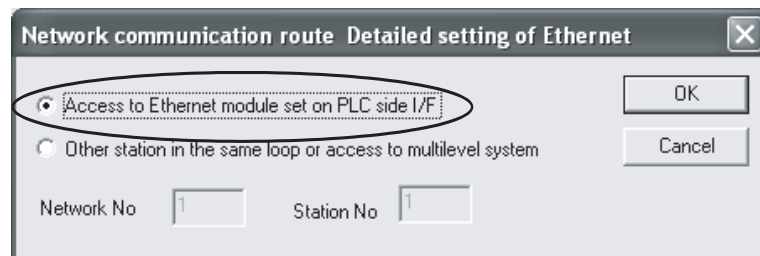

INDEX

- [5]
5VDC internal current consumption 3- 2
- [A]
Access points 7-22
Applicable system 2- 1
Assignment points 7-28
Auto refresh setting 8-15
Automatic communication status 8-24
Automatic communication function 5- 3
 Automatic communication function buffer areas 5- 7
 Automatic communication function communication time App- 2
 Automatic communication function error code storage area 11-18
 Automatic communication function performance App- 2
 Automatic communication operation flowchart 5- 6
 Automatic communication operation status 5- 5
 Automatic communication operation status storage area 11-17
 Automatic communication start/stop timing chart 5- 4
 Precautions for starting/stopping the automatic communication function 5- 4
 Start and stop of automatic communication function 5- 3
 Target slave port No. for automatic communication function 7-17
Automatic communication parameter error code storage area 11-16
Automatic communication parameter screen 8-33
Automatic communication parameter setting 9- 4
 I/O signals for setting 9- 4
 Setting method 9- 4
 Setting precautions 9- 6
 Timing charts for setting 9- 5
Automatic communication parameter setting result storage area 11-15
Automatic communication parameters 7-19
Automatic response function 5-10
- [B]
Basic parameter setting 9- 1
 I/O signals for setting 9- 1
 Setting method 9- 1
 Setting precautions 9- 3
 Timing charts for setting 9- 2
Basic parameters 7- 6
 Basic parameter error code storage area 11-15
 Basic parameter screen 8-30
 Basic parameter starting method 6-12
Basic/MODBUS[®] device assignment parameter status 8-23
Buffer memory 3- 5
Buffer memory addresses used for PING test 11-44
- [C]
Coil 7-25
Coil assignment 1 7-26
COM.ERR. LED turn-off 11-40
Common utility package operations 8- 6
Communication condition setting 6-12
Communication status 8-27
Connection precautions 6- 6
Connection to 10BASE-T/100BASE-TX 6- 6
Connection to Ethernet 6- 6
Connector applicable for external wiring 3- 2
Control keys 8- 6
CPU response monitoring timer value 7-17
- [D]
Data transmission rate 3- 2
Dedicated instructions 5- 9
 Dedicated instruction list 10- 1
 Dedicated instruction performance App- 4
 Dedicated instruction processing time .. App- 4
 MBREQ Instruction 10-11
 MBRW Instruction 10- 2
Default assignment parameters 7-29
Default router IP address 7-13
Device code 7-27
Device symbol 7-27

[E]			
	Error code list	11-23	
	Error code storage areas	11-15	
	Error codes	11-15	
	Error log	8-26, 11-18	
	Error log area	11-18	
	Error log write pointer	11-18	
	Ethernet function	5- 1	
	Exception code list	11-21	
	Extended file register	7-25	
	External dimensions	App- 1	
[F]			
	Features	1- 1	
	Fraction bits	7-22	
	Frame specifications	4- 3	
	Application data	4- 3	
	Ethernet header	4- 3	
	FCS	4- 3	
	IP header	4- 3	
	MBAP header	4- 3	
	Message length	4- 3	
	MODBUS® /TCP application data unit	4- 3	
	MODBUS® application header	4- 3	
	MODBUS® /TCP ADU	4- 3	
	Module ID	4- 3	
	PDU	4- 3	
	Protocol data unit	4- 3	
	Protocol ID	4- 3	
	TCP header	4- 3	
	Transaction ID	4- 3	
	Function list	5- 1	
	Function version	2- 7	
[G]			
	GX Configurator-MB	8- 1	
	GX Developer		
	Accessible range	5-15	
	GX Developer connection function	5-15	
	GX Developer connection information		
	setting	7-16	
	GX Developer connection setup	5-15	
	GX Developer connection setup		
	example	App- 6	
	Number of TCP connections for GX		
	Developer connection	7-16	
	System monitor of GX Developer	11-12	
[H]			
	Handling precautions	6- 1	
	Hardware test	6- 8	
	Head buffer memory address	7-21	
	Head coil number	7-28	
	Head device number	7-28	
	Head holding register number	7-28	
	Head input number	7-28	
	Head input register number	7-28	
	Head MODBUS® device number	7-28	
	Holding register	7-25	
	Holding register assignment 1	7-26	
[I]			
	I/O signals	3- 3	
	Indications of indicator LEDs	6- 5	
	Initial setting	8-13	
	Input	7-25	
	Input assignment 1	7-26	
	Input register	7-25	
	Input register assignment 1	7-26	
	Intelligent function module parameters	8- 8	
	Intelligent function module switch setting	6-10	
	Intelligent function module switch setting		
	items	6-11	
	Starting procedure for intelligent function		
	module switch setting screen	6-10	
	IP address setting	6-14	
	IP reassembly timer value	7- 8	
[K]			
	KeepAlive function	5-12, 7-11	
	KeepAlive interval timer value	7-11	
	KeepAlive resend count	7-11	
	KeepAlive start timer value	7-11	
	Operation of KeepAlive function	5-12	
	To use KeepAlive function	5-12	
[L]			
	LED		
	100M	6- 5	
	COM.ERR.	6- 5	
	ERR.	6- 5	
	INIT.	6- 5	
	OPEN	6- 5	
	RD	6- 5	
	RUN	6- 5	

SD	6- 5
Local slave station port No.....	7-17

[M]

Master function.....	5- 1
Master function performance	App- 2
Max. number of modules	2- 1
Maximum node-to-node distance	3- 2
Maximum number of connections	3- 2
Maximum number of parameter settings.....	8- 3
Maximum segment length.....	3- 2
MODBUS® device	
MODBUS® device assignment function ...	5-11
MODBUS® device assignment parameter	
error code storage area.....	11-16
MODBUS® device assignment parameter	
setting result storage area.....	11-16
MODBUS® device assignment parameter	
starting method.....	6-13
MODBUS® device assignment parameters	
.....	7-23
MODBUS® device assignment parameters	
details.....	7-26
MODBUS® device sizes.....	7-25
MODBUS(R) device assignment parameter	
screen	8-35
MODBUS® device assignment parameter	
setting	9- 7
I/O signals for setting.....	9- 7
Setting method	9- 7
Setting precautions.....	9-10
Timing charts for setting.....	9- 8
MODBUS® extended file register assignment	
.....	7-31
MODBUS® extended file register size	7-31
MODBUS® standard functions.....	4- 1
Mask write register	4-19
Read coils	4- 6
Read discrete inputs.....	4- 7
Read file record	4-15
Read holding registers	4- 8
Read input registers	4- 9
Read/Write multiple registers.....	4-20
Write file record.....	4-17
Write multiple coils.....	4-12
Write multiple registers.....	4-14
Write single coil.....	4-10
Write single register.....	4-11

MODBUS® /TCP setting	7-17
Module ID	7-20
Monitor/test	8-17
Multiple CPU system	2- 1

[N]

Network configuration	2- 3
Number of cascade connection stages.....	3- 2
Number of errors occurred	11-18
Number of occupied I/O points.....	3- 2
Number of routers set.....	7-13
Number of routers that can be set.....	3- 2

[O]

Online change enable/disable setting	6-13
Operating environment	8- 4
Operation mode setting	6-11

[P]

Parameter setting method	7- 1
Parameter setting procedures	7- 2
Parameter types.....	7- 1
Part names.....	6- 4
PDU formats.....	4- 4
Performance specifications	3- 2
PING test.....	8-29,11-44
Preferred node specification.....	7-18
Preferred node specification: IP address	7-18
Preferred node specification: TCP	
connection.....	7-18
Pre-operational procedures and setting.....	6- 2
Processing time	App- 2
Program example	
Program example for use in normal	
system configuration	9-11
Program example for use in MELSECNET/H	
remote I/O network	9-29

[Q]

QJ71MT91 buffer memory assignment	7-32
QJ71MT91 status confirmation	11-12

[R]

Relationship between COM.ERR. LED and	
I/O signals	11-43
Relationship between PING test and I/O	
signals	11-49
Repeat interval timer value.....	7-20

Request message format.....	4- 4
Request message processing time	App- 5
Response message format.....	4- 4
Response monitoring timer value	7-20
Router information: Router IP address.....	7-15
Router information: Subnet address.....	7-13
Router relay function	5-14,7-12
To use router relay function	5-14
Routing information	7-12

[S]

Self-loopback test.....	6- 9
Send frame specification.....	6-12
Set values of default assignment parameters	7-30
Slave function.....	5- 1
Slave function performance	App- 5
Software packages.....	2- 2
Software version.....	2- 9
Split reception monitoring timer value	7- 9
Starting the Intelligent function module utility	8-11
Subnet mask pattern.....	7-12
Switch 1	6-11
Switch 2	6-12
Switch 3	6-14
Switch 4	6-14
Switch 5	6-15
System configuration.....	2- 1,2- 6

[T]

Target MODBUS® device head number.....	7-21
Target station IP address.....	7-20
TCP end timer value	7- 8
TCP resend timer value	7- 8
TCP ULP timer value	7- 8
TCP zero window timer value	7- 8
TCP/UDP/IP monitoring timer.....	7- 8
TCP/UDP/IP setting	7- 8
Text file	8- 8
Transmission method.....	3- 2
Troubleshooting.....	11- 1
Troubleshooting for other symptoms	11- 7
Troubleshooting of errors indicated by LEDs	11- 1
Troubleshooting of errors indicated by X signals.....	11- 3

Type specification of the target MODBUS® device	7-22
--	------

[U]

Utility Package	8- 1
GX Configurator-MB functions.....	8- 1
Installation of utility package	8- 2
Uninstallation of utility package	8- 2

[W]

Watch dog timer error	3- 4
Weight	3- 2

[X]

X/Y Monitor/test	8-21
------------------------	------

WARRANTY

Please confirm the following product warranty details before using this product.

1. Gratis Warranty Term and Gratis Warranty Range

If any faults or defects (hereinafter "Failure") found to be the responsibility of Mitsubishi occurs during use of the product within the gratis warranty term, the product shall be repaired at no cost via the sales representative or Mitsubishi Service Company.

However, if repairs are required onsite at domestic or overseas location, expenses to send an engineer will be solely at the customer's discretion. Mitsubishi shall not be held responsible for any re-commissioning, maintenance, or testing on-site that involves replacement of the failed module.

[Gratis Warranty Term]

The gratis warranty term of the product shall be for one year after the date of purchase or delivery to a designated place.

Note that after manufacture and shipment from Mitsubishi, the maximum distribution period shall be six (6) months, and the longest gratis warranty term after manufacturing shall be eighteen (18) months. The gratis warranty term of repair parts shall not exceed the gratis warranty term before repairs.

[Gratis Warranty Range]

- (1) The range shall be limited to normal use within the usage state, usage methods and usage environment, etc., which follow the conditions and precautions, etc., given in the instruction manual, user's manual and caution labels on the product.
- (2) Even within the gratis warranty term, repairs shall be charged for in the following cases.
 1. Failure occurring from inappropriate storage or handling, carelessness or negligence by the user. Failure caused by the user's hardware or software design.
 2. Failure caused by unapproved modifications, etc., to the product by the user.
 3. When the Mitsubishi product is assembled into a user's device, Failure that could have been avoided if functions or structures, judged as necessary in the legal safety measures the user's device is subject to or as necessary by industry standards, had been provided.
 4. Failure that could have been avoided if consumable parts (battery, backlight, fuse, etc.) designated in the instruction manual had been correctly serviced or replaced.
 5. Failure caused by external irresistible forces such as fires or abnormal voltages, and Failure caused by force majeure such as earthquakes, lightning, wind and water damage.
 6. Failure caused by reasons unpredictable by scientific technology standards at time of shipment from Mitsubishi.
 7. Any other failure found not to be the responsibility of Mitsubishi or that admitted not to be so by the user.

2. Onerous repair term after discontinuation of production

- (1) Mitsubishi shall accept onerous product repairs for seven (7) years after production of the product is discontinued. Discontinuation of production shall be notified with Mitsubishi Technical Bulletins, etc.
- (2) Product supply (including repair parts) is not available after production is discontinued.

3. Overseas service

Overseas, repairs shall be accepted by Mitsubishi's local overseas FA Center. Note that the repair conditions at each FA Center may differ.

4. Exclusion of loss in opportunity and secondary loss from warranty liability

Regardless of the gratis warranty term, Mitsubishi shall not be liable for compensation of damages caused by any cause found not to be the responsibility of Mitsubishi, loss in opportunity, lost profits incurred to the user by Failures of Mitsubishi products, special damages and secondary damages whether foreseeable or not, compensation for accidents, and compensation for damages to products other than Mitsubishi products, replacement by the user, maintenance of on-site equipment, start-up test run and other tasks.

5. Changes in product specifications

The specifications given in the catalogs, manuals or technical documents are subject to change without prior notice.

Microsoft, Windows, Windows Vista, Windows NT, Windows XP, Windows Server, Visio, Excel, PowerPoint, Visual Basic, Visual C++, and Access are either registered trademarks or trademarks of Microsoft Corporation in the United States, Japan, and other countries.

Intel, Pentium, and Celeron are either registered trademarks or trademarks of Intel Corporation in the United States and other countries.

Ethernet is a registered trademark of Xerox Corp.

MODBUS is the registered trademark of SCHNEIDER AUTOMATION INC.

All other company names and product names used in this manual are either trademarks or registered trademarks of their respective companies.

SPREAD

Copyright (c) 1996 FarPoint Technologies, Inc.

SH-080446ENG-H(1410)MEE

MODEL: QJ71MT91-U-SY-E

MODEL CODE: 13JR71

MITSUBISHI ELECTRIC CORPORATION

HEAD OFFICE : TOKYO BUILDING, 2-7-3 MARUNOUCHI, CHIYODA-KU, TOKYO 100-8310, JAPAN
NAGOYA WORKS : 1-14, YADA-MINAMI 5-CHOME, HIGASHI-KU, NAGOYA, JAPAN

When exported from Japan, this manual does not require application to the
Ministry of Economy, Trade and Industry for service transaction permission.

Specifications subject to change without notice.